



# MIC37110/MIC37112 MIC37120/MIC37122

High-Performance, Low-Noise,  
1A LDOs

## General Description

The MIC37110/MIC37112 and MIC37120/MIC37122 are high-performance, low-noise, low dropout regulators. Each of these LDOs is capable of sourcing 1A output current, offers high power supply rejection, and low output noise. These general purpose LDOs are most suitable for consumer applications such as multimedia devices, set-top boxes, Blu-ray players, handheld devices, and gaming consoles.

The MIC37112 and MIC37122 feature adjustable output voltages while the MIC37110 and MIC37120 come in fixed 1.8V output voltage options. All devices feature 2% initial output voltage accuracy, typical dropout of 230mV at 1A, and low ground current.

This family of low-noise regulators is available in 2mm x 2mm Thin MLF<sup>®</sup>, SOIC-8 and SOT-223 packages and they all have an operating junction temperature range of -40°C to +125°C.

Data sheets and support documentation can be found on Micrel's web site at: [www.micrel.com](http://www.micrel.com).

## Features

- Input voltage range: 2.375V to 5.5V
- Output voltage adjustable down to 1.0V (MIC37112/MIC37122)
- Stable with small, 2.2µF ceramic output capacitor
- 230mV typical dropout at 1A
- 1A minimum guaranteed output current
- ±2.0% initial accuracy
- Low ground current
- High PSRR: >60dB, up to 1kHz
- Output auto-discharge circuit (MIC37120/MIC37122)
- Thermal-shutdown and current-limit protection

## Applications

- Mobile phones and consumer multimedia devices
- Set-top boxes and Blu-ray players
- Gaming consoles
- Tablets and handheld devices
- GPS receivers

## Typical Application

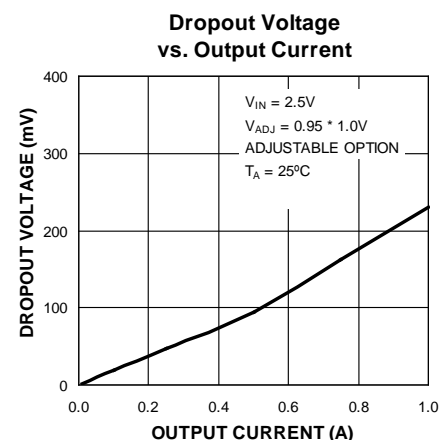
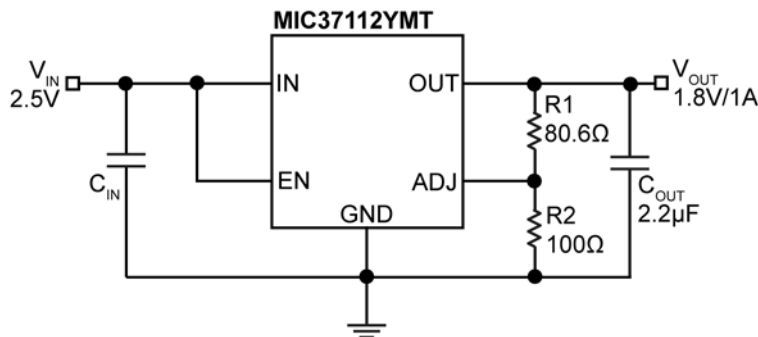

MLF and MicroLeadFrame are registered trademarks of Amkor Technology, Inc.

Micrel Inc. • 2180 Fortune Drive • San Jose, CA 95131 • USA • tel +1 (408) 944-0800 • fax +1 (408) 474-1000 • <http://www.micrel.com>

## Ordering Information

Part Number <sup>(1,2)</sup>	Output Voltage	Top Mark	Output Auto-Discharge	Package
MIC37110-1.8YS	1.8V	ZHG	No	SOT-223-3L
MIC37110-1.8YM	1.8V	–	No	SOIC-8L
MIC37110-1.8YMT	1.8V	GHZ	No	2mm × 2mm Thin MLF-6L
MIC37112YM	Adjustable	–	No	SOIC-8L
MIC37112YMT	Adjustable	AZZ	No	2mm × 2mm Thin MLF-6L
MIC37120-1.8YM	1.8V	–	Yes	SOIC-8L
MIC37120-1.8YMT	1.8V	1H8	Yes	2mm × 2mm Thin MLF-6L
MIC37122YM	Adjustable	–	Yes	SOIC-8L
MIC37122YMT	Adjustable	ZAZ	Yes	2mm × 2mm Thin MLF-6L

**Note:**

1. RoHS compliant with 'high-melting solder' exemption.
2. Temperature range is -40°C to +125°C

## Pin Configuration

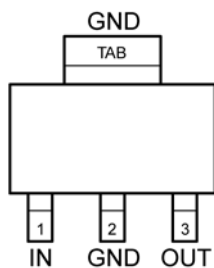

**SOT-223 (S)**  
**MIC371x0-1.8 (Fixed)**

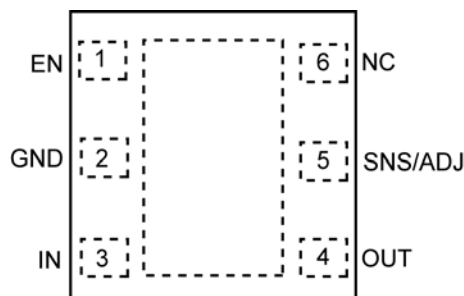

**2mm x 2mm Thin MLF - 6 Lead (MT)**  
**MIC371xx (Fixed/Adjustable)**

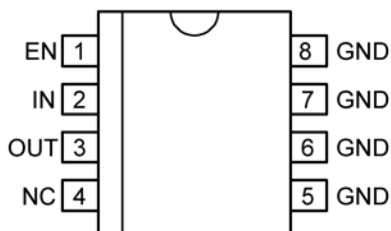

**8-Pin SOIC (M)**  
**MIC371x0-1.8 (Fixed)**

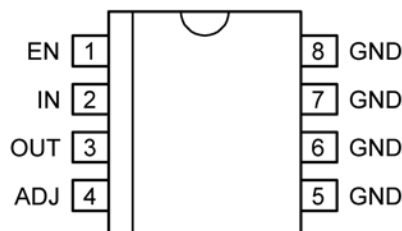

**8-Pin SOIC (M)**  
**MIC371x2 (Adjustable)**

**Pin Description**

Pin Number SOT-223 -3L	Pin Number SOIC-8 (Fixed)	Pin Number SOIC-8 (Adjustable)	Pin Number 2mm × 2mm Thin MLF-6L	Pin Name	Pin Description
—	1	1	1	EN	Enable (Input): CMOS-compatible control input. Logic high = enable, logic low = shutdown.
1	2	2	3	IN	Supply (Input).
3	3	3	4	OUT	Regulator Output.
—	—	4	5	ADJ	Adjustment Input: Feedback input. Connect to resistive voltage-divider network to set the output voltage of the MIC37112/MIC37122.
		—	5	SNS	Output Voltage Sense Input. Connect this pin at the point-of-load to monitor the output voltage of the fixed output voltage options.
2, TAB	5-8	5-8	2	GND	Ground.
—	4	—	6	NC	Not internally connected

**Absolute Maximum Ratings<sup>(1)</sup>**

Supply Voltage ( $V_{IN}$ )	-0.3V to +6V
Enable Voltage ( $V_{EN}$ )	-0.3V to $V_{IN}$
Adjust Pin Voltage ( $V_{ADJ}$ )	-0.3V to $V_{IN}$
Lead Temperature (soldering, 5s)	260°C
Storage Temperature ( $T_s$ )	-65°C to +150°C
ESD Rating <sup>(3)</sup>	
HBM	3kV

**Operating Ratings<sup>(2)</sup>**

Supply Voltage ( $V_{IN}$ )	+2.375V to +5.5V
Enable Voltage ( $V_{EN}$ )	0V to $V_{IN}$
Power Dissipation ( $P_{D(max)}$ )	Internally Limited <sup>(4)</sup>
Junction Temperature ( $T_J$ )	-40°C to +125°C
Package Thermal Resistance	
SOT-223 ( $\theta_{JA}$ )	40°C/W
SOIC-8 ( $\theta_{JA}$ )	63°C/W
Thin MLF-6 ( $\theta_{JA}$ )	100°C/W

**Electrical Characteristics<sup>(5)</sup>**

$V_{IN} = V_{EN} = V_{OUT} + 1V$ ;  $I_{OUT} = 10mA$ ;  $C_{IN} = 1.0 \mu F$ ;  $C_{OUT} = 2.2 \mu F$ ;  $T_J = 25^\circ C$ , **bold** values indicate  $-40^\circ C \leq T_J \leq +125^\circ C$ , unless noted.

Parameter	Condition	Min.	Typ.	Max.	Units
<b>Power Supply Input</b>					
Input Voltage Range ( $V_{IN}$ )		<b>2.375</b>		<b>5.5</b>	V
Input Supply UVLO				<b>2.2</b>	V
Input Supply UVLO Hysteresis			100		mV
Ground Pin Current <sup>(6)</sup>	$10mA \leq I_{OUT} \leq 1.0A$		250	<b>500</b>	$\mu A$
Ground Current in Shutdown	$V_{EN} = V_{OUT} = 0V$		0.1	5	$\mu A$
<b>Reference</b>					
Adjust Pin Voltage	Adjustable Option	<b>0.975</b>	1	<b>1.025</b>	V
Output Voltage Accuracy	Fixed Option	-2		+2	%
		<b>-2.5</b>		<b>+2.5</b>	
Load Regulation	$I_{OUT} = 10mA$ to 1A	-1.0		+1.0	%
Line Regulation	$V_{IN} = (V_{OUT} + 1V)$ to 5.5V		0.05	0.5	%
ADJ Pin Current	$V_{ADJ} = 1.0V$		0.01	<b>1</b>	$\mu A$
<b>Current Limit</b>					
Current Limit	$V_{OUT} = 0V$	<b>1.2</b>	2.3	<b>4.0</b>	A
<b>Dropout Voltage</b>					
Dropout Voltage ( $V_{IN} - V_{OUT}$ ) <sup>(7)</sup>	$I_{OUT} = 1A$		230	<b>400</b>	mV
<b>Load Discharge Resistance (MIC37120/MIC37122)</b>					
Load Discharge Resistance	$V_{EN} = 0V$ ; $V_{IN} = 3.6V$ ; $I_{OUT} = 3mA$		30		$\Omega$
<b>Enable Input</b>					
Enable Logic Level High		<b>1.2</b>	0.75		V
Enable Logic Level Low			0.65	<b>0.25</b>	V
EN Hysteresis			100		mV
EN Pin Current	$V_{EN} = 0.2V$ (Regulator Shutdown)		0.1	<b>1</b>	$\mu A$
	$V_{IN} = V_{EN} = 3.6V$ (Regulator Enabled)		0.1	<b>1</b>	

**Electrical Characteristics<sup>(5)</sup> (Continued)**

$V_{IN} = V_{EN} = V_{OUT} + 1V$ ;  $I_{OUT} = 10mA$ ;  $C_{IN} = 1.0 \mu F$ ;  $C_{OUT} = 2.2\mu F$ ;  $T_J = 25^\circ C$ , **bold** values indicate  $-40^\circ C \leq T_J \leq +125^\circ C$ , unless noted.

Parameter	Condition	Min.	Typ.	Max.	Units
<b>Enable Input</b>					
Start-Up Time			140	<b>500</b>	$\mu s$
<b>Minimum Load Current</b>					
Minimum Load Current		<b>10</b>			mA
<b>Thermal Protection</b>					
Over-Temperature Shutdown	$T_J$ Rising		160		$^\circ C$
Over-Temperature Shutdown Hysteresis			15		$^\circ C$

**Notes:**

- Exceeding the absolute maximum rating may damage the device.
- The device is not guaranteed to function outside its operating rating.
- Devices are ESD sensitive. Handling precautions recommended.
- $P_{D(max)} = (T_{J(max)} - T_A) \div \theta_{JA}$ , where  $\theta_{JA}$  depends upon the printed circuit layout. See "Applications Information" section.
- Specification for packaged product only.
- $I_{GND}$  is the quiescent current.  $I_{IN} = I_{GND} + I_{OUT}$ .
- $V_{DO} = V_{IN} - V_{OUT}$  when  $V_{OUT}$  decreases to 98% of its nominal output voltage with  $V_{IN} = V_{OUT} + 1V$ . For output voltages below 2.25V, dropout voltage is the input-to-output voltage differential with the minimum input voltage being 2.25V. The minimum input operating voltage is 2.375V.

## Typical Characteristics

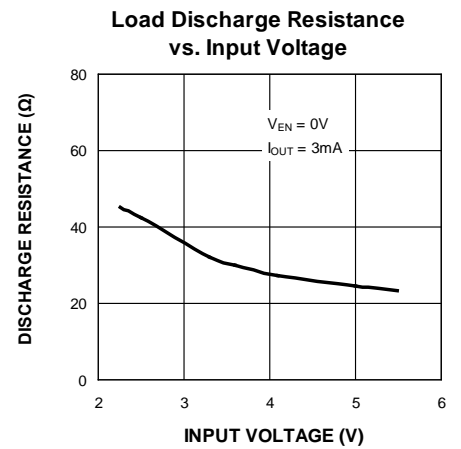
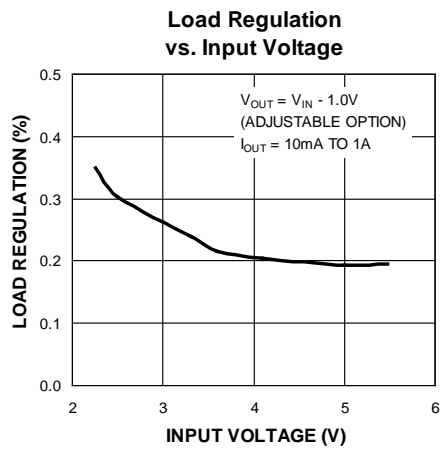
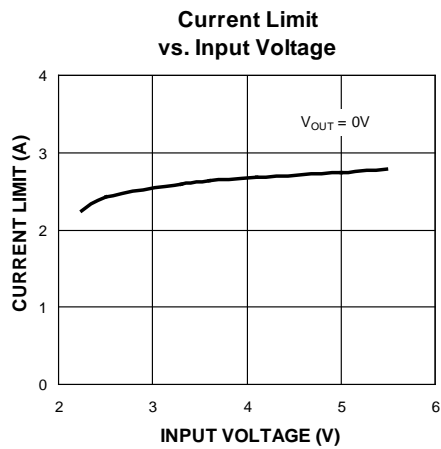
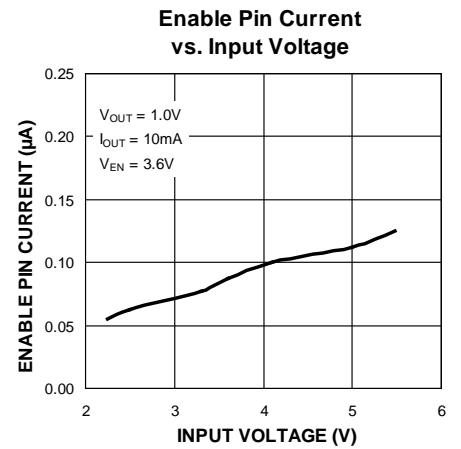
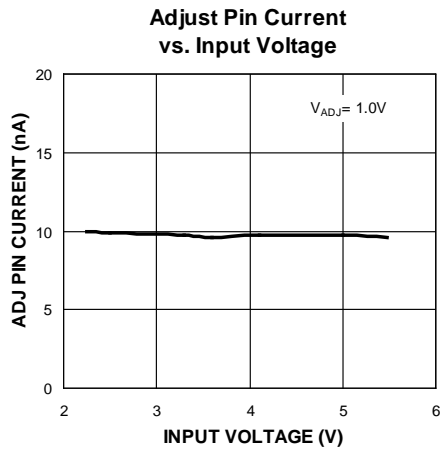
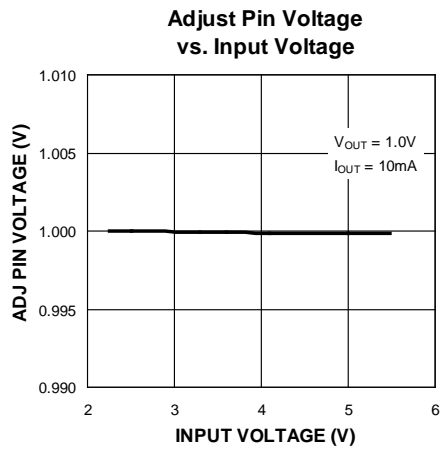
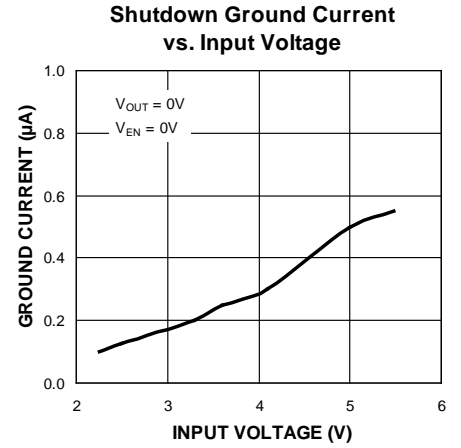
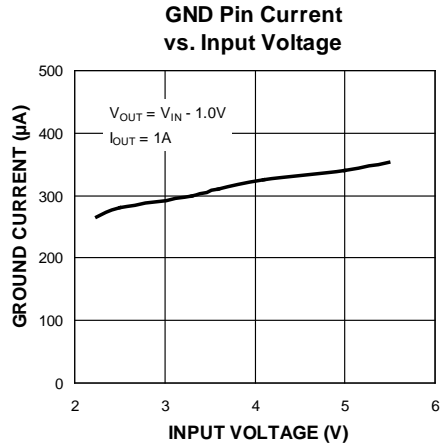
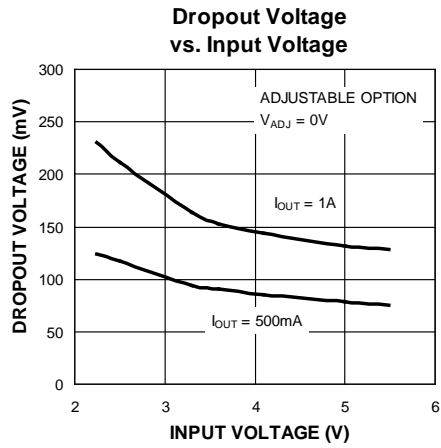

Typical Characteristics (Continued)

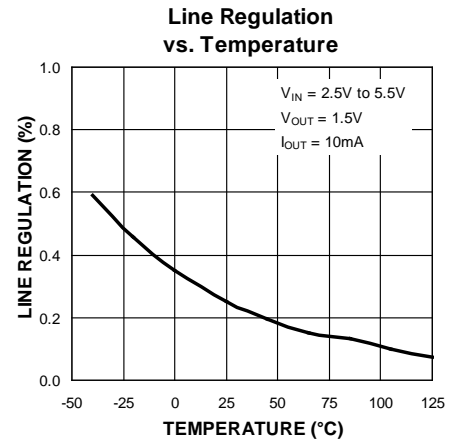
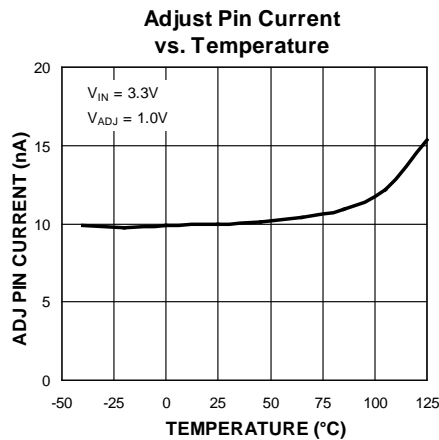
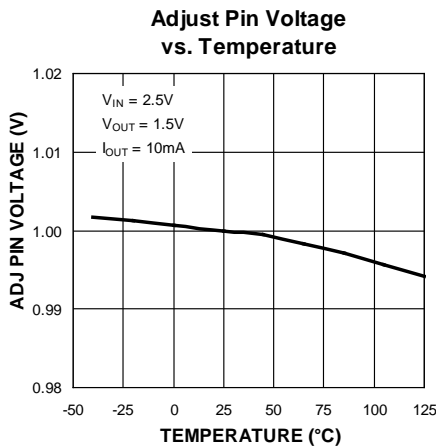
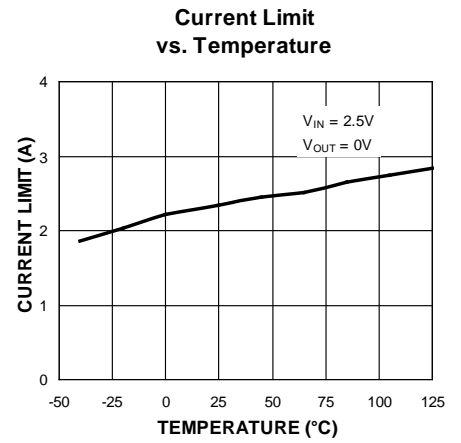
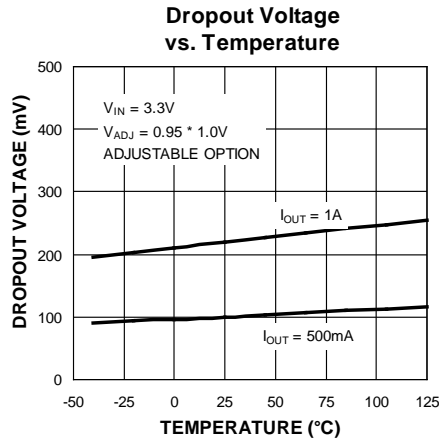
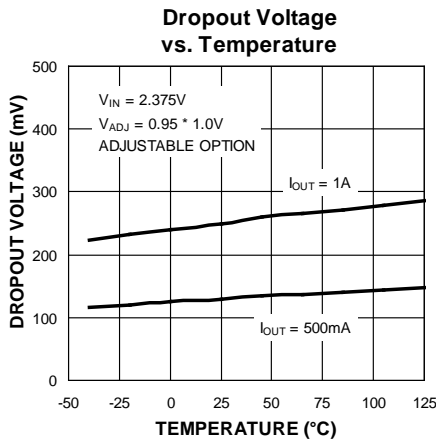
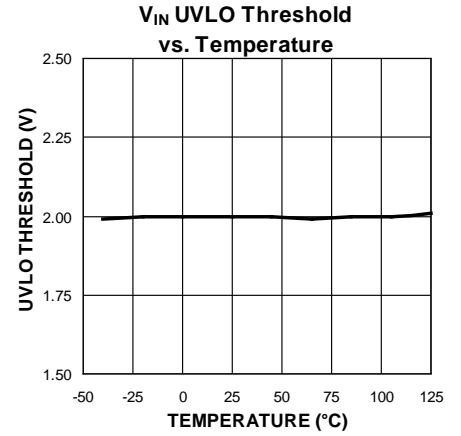
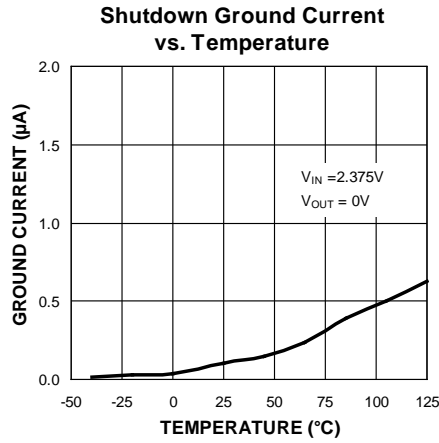
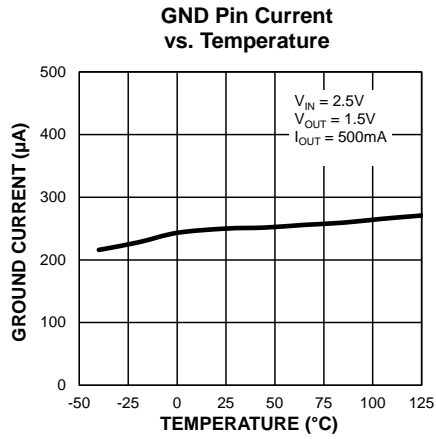

Typical Characteristics (Continued)

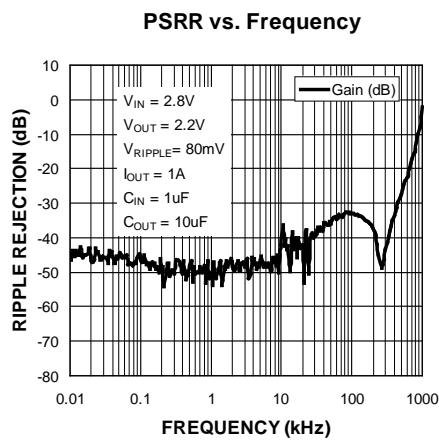
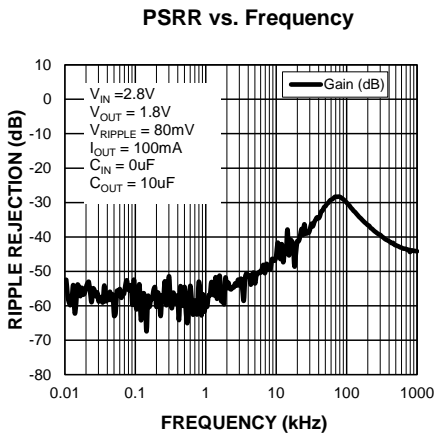
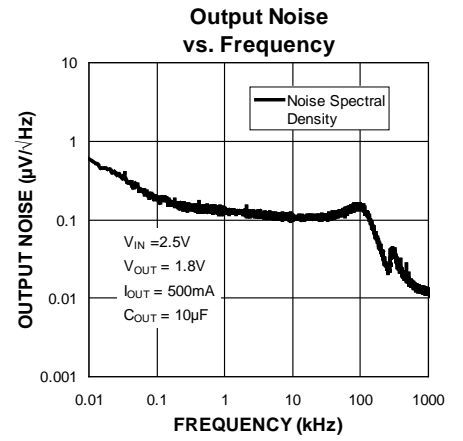
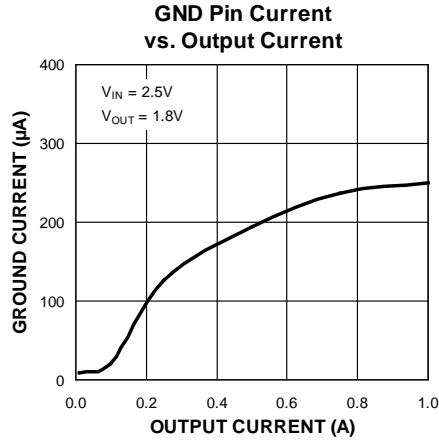
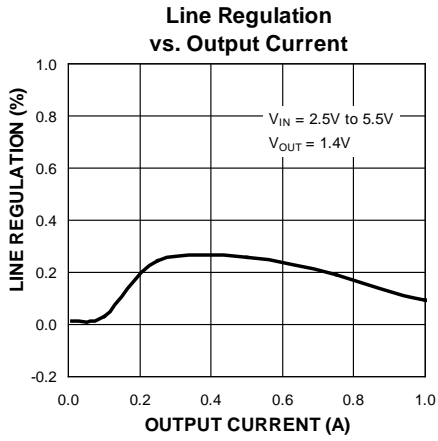
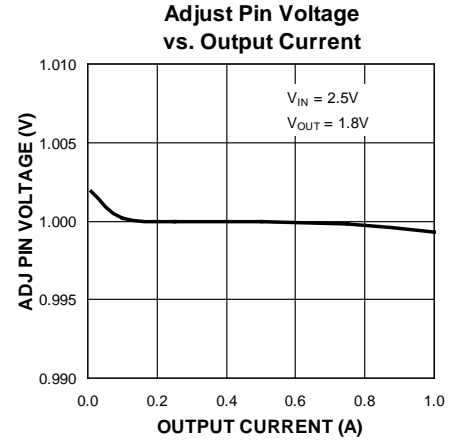
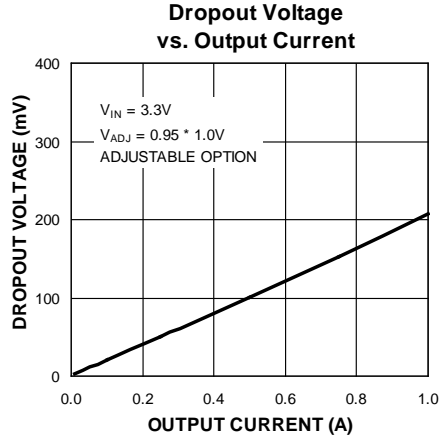
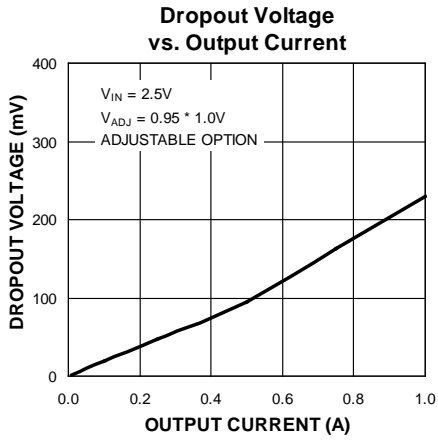



## Typical Characteristics (Continued)

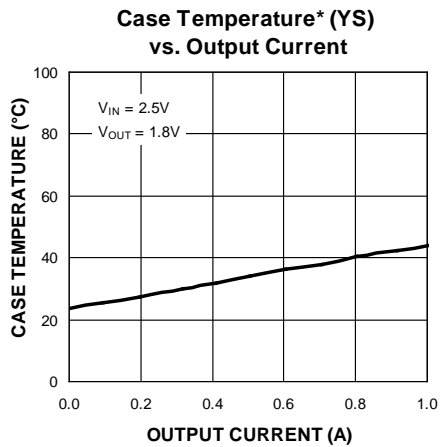
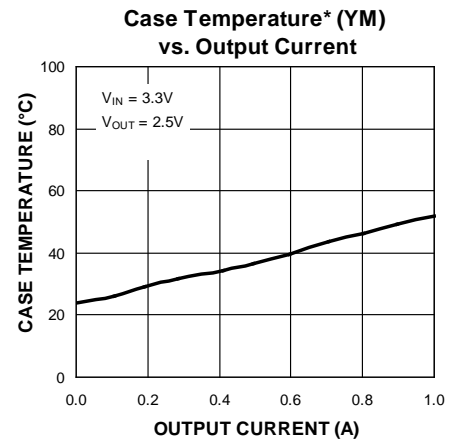
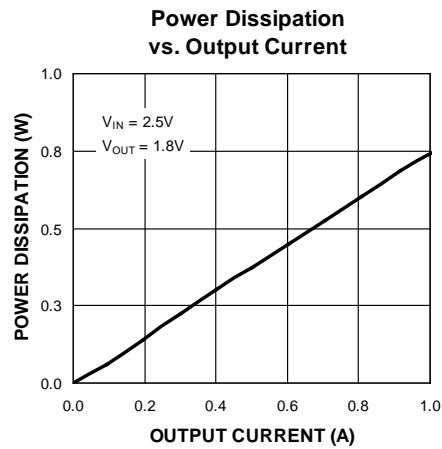
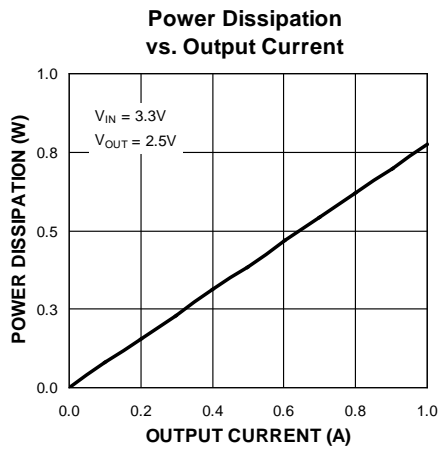

**Case Temperature\*:** The temperature measurement was taken at the hottest point on the MIC371xx that was case mounted on a 2.25 square inch PCB at an ambient temperature of 25°C; see "Thermal Measurement" section. Actual results will depend upon the size of the PCB, ambient temperature and proximity to other heat-emitting components.

### Functional Characteristics

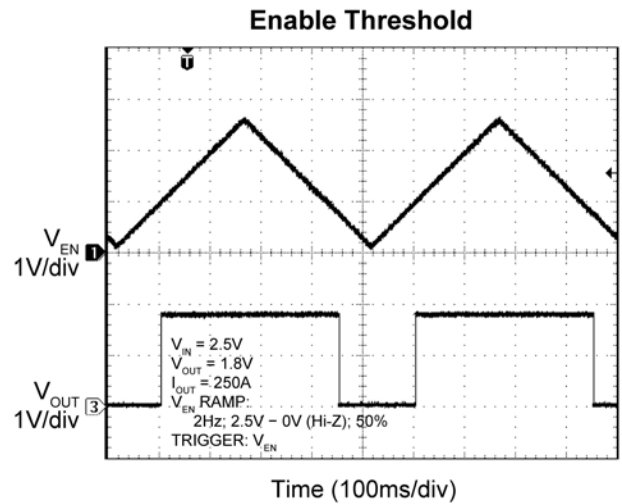
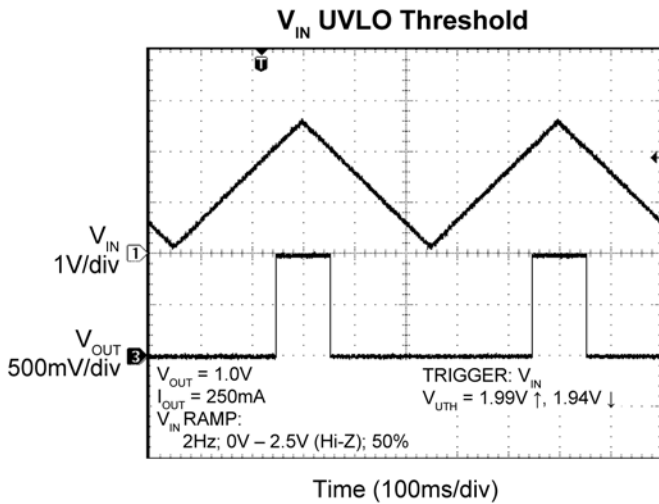
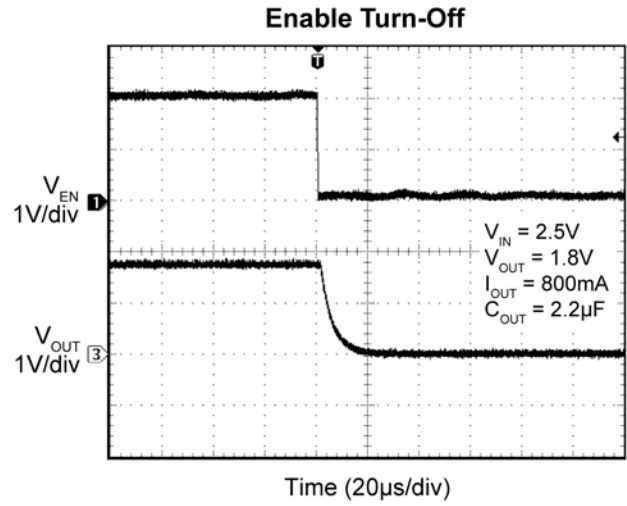
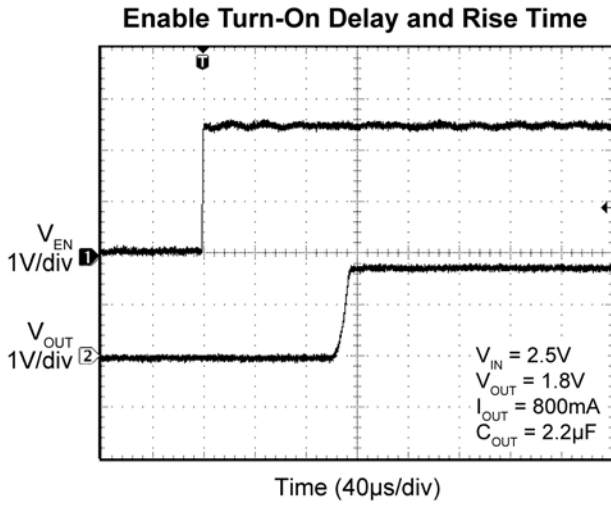
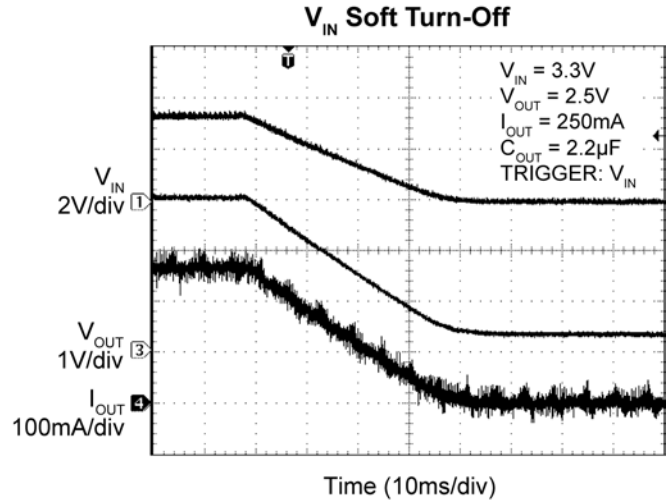
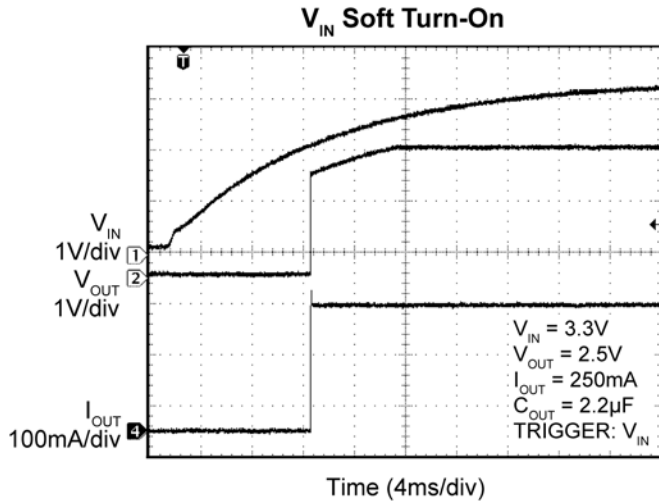

### Functional Characteristics (Continued)

**Current Limit Threshold**

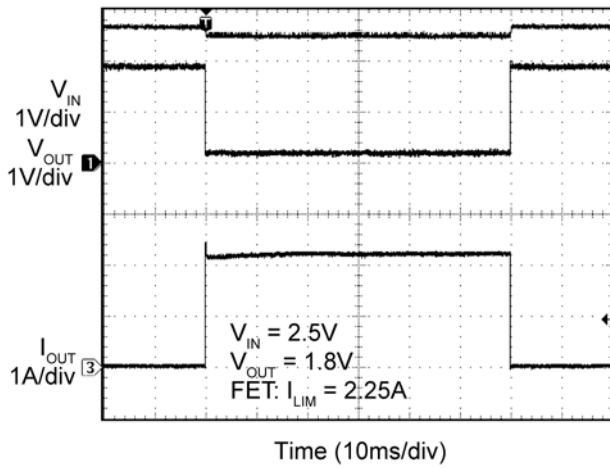

**Thermal Shutdown Response**

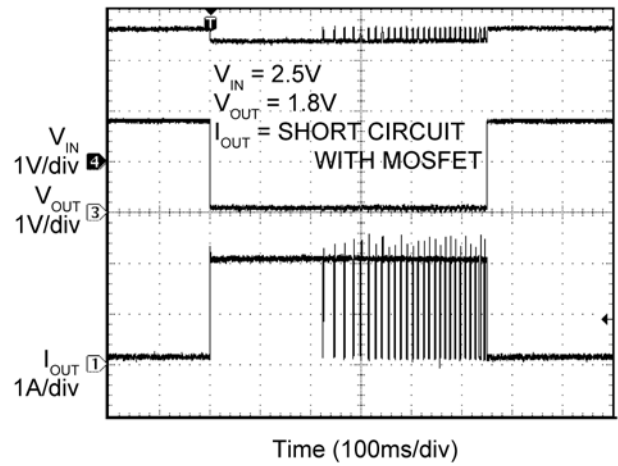

**Power-Up into Short**

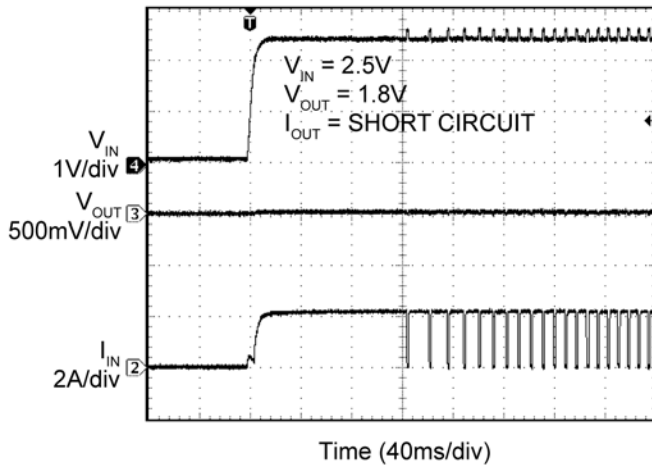

**Enable Turn-On into Short Circuit**

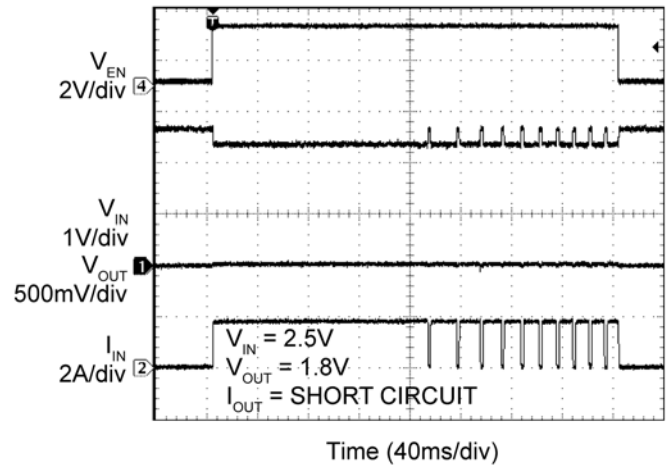

**Short-Circuit Response Time**

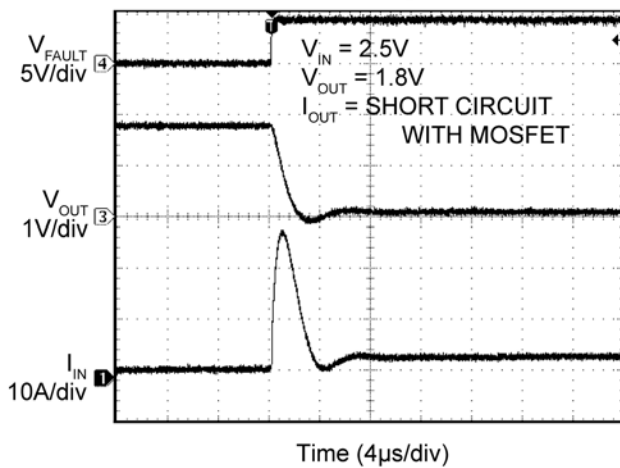

**Short-Circuit Output Voltage Recovery**

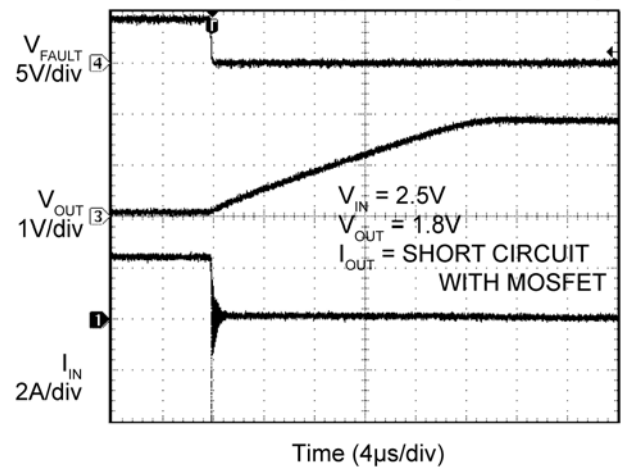

### Functional Characteristics (Continued)

**Inrush Current,  $C_{OUT} = 2.2\mu F$**

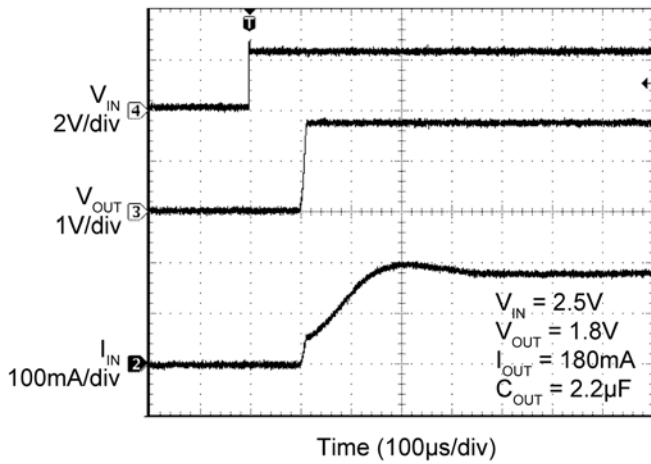

**Inrush Current,  $C_{OUT} = 220\mu F$**

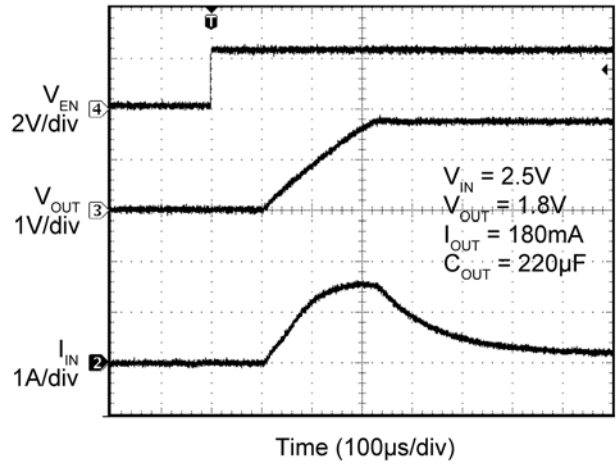

**Fast Load Transient Response**

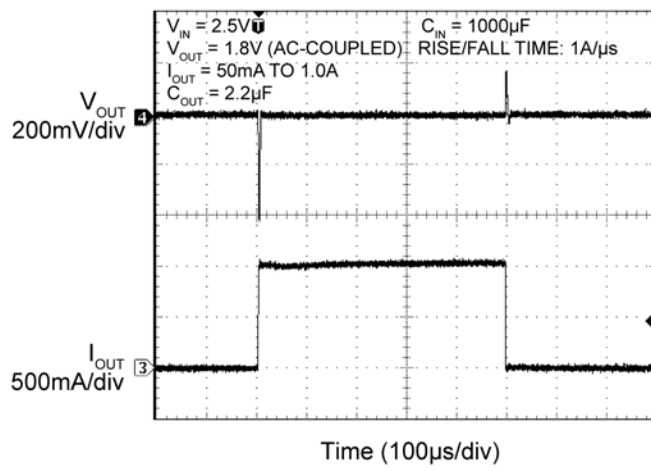

**Fast Load Transient Response**

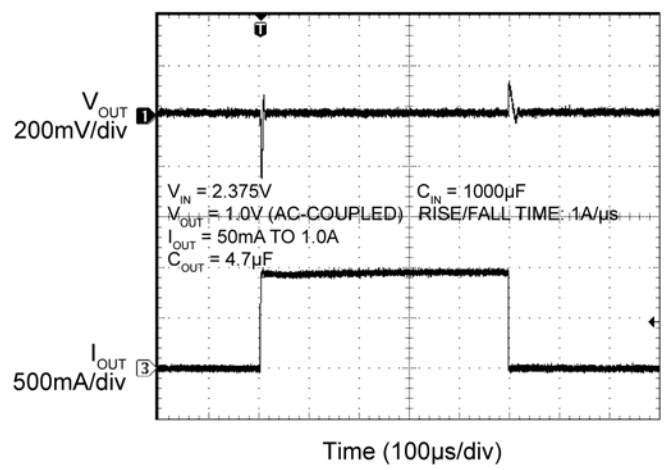

**Line Transient Response**

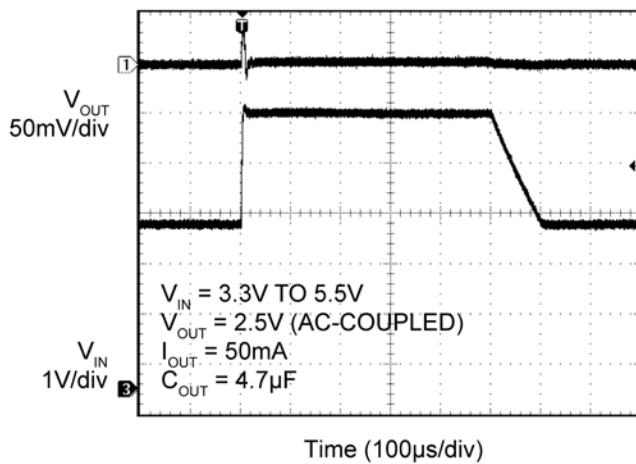

## Functional Diagrams

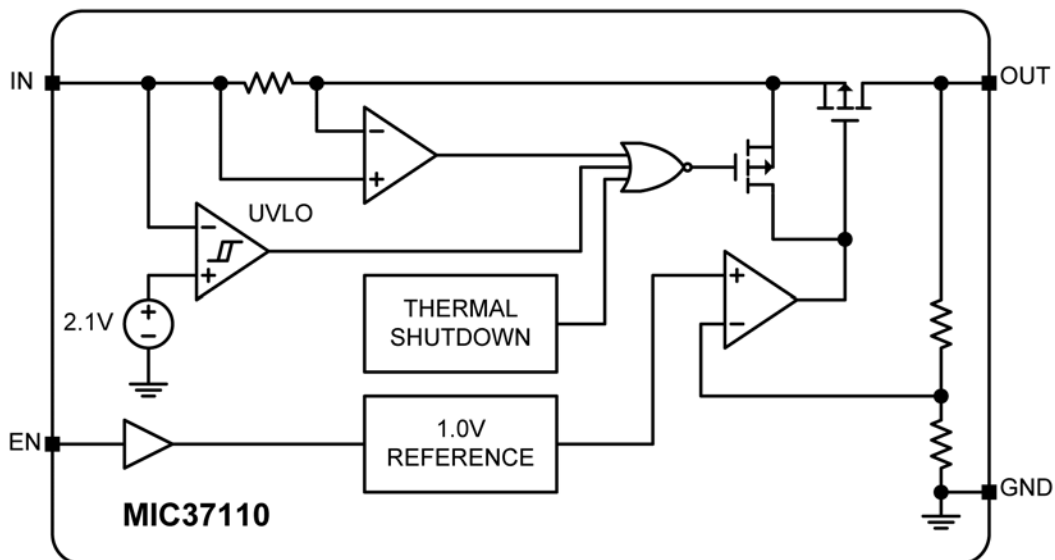

MIC37110 Functional Diagram – Fixed Voltage

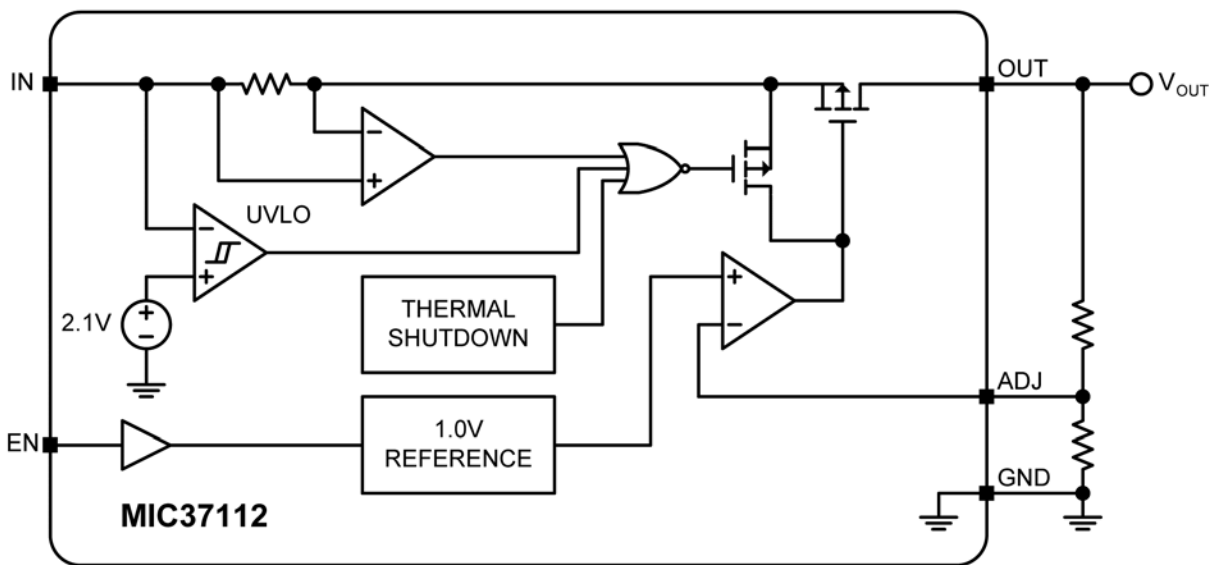

MIC37112 Functional Diagram – Adjustable Voltage

## Application Information

The MIC37110/2 and MIC37120/2 are high-performance, low-noise, low-voltage regulators suitable for moderate current consumer applications such as mobile phones, set-top boxes, and gaming consoles. The MIC37110/2 and MIC37120/2 are capable of sourcing 1A output, offer high PSRR and low output noise. With a 400mV dropout voltage at full load and over temperature, these ICs are especially valuable in battery-powered systems and as high-efficiency noise filters in post-regulator applications.

The MIC37110/12 and MIC37120/22 regulators are fully protected from damage due to fault conditions. Linear current limiting is provided. Output current during overload conditions is constant. Thermal shutdown disables the device when the die temperature exceeds the maximum safe operating temperature. The output structure of these regulators allows voltages in excess of the desired output voltage to be applied without reverse current flow.

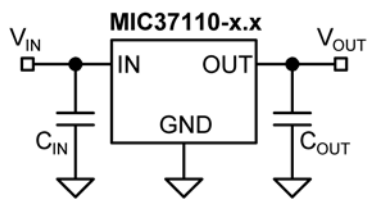

Figure 1. Capacitor Requirements

### Output Capacitor

The MIC37110/2 and MIC37120/2 requires an output capacitor to maintain stability and improve transient response. The MIC37110/2 and MIC37120/2 require a 2.2 $\mu$ F or greater output capacitor to maintain stability. Larger capacitor values may be used but the device is optimized for 2.2 $\mu$ F and optimum performance is achieved with the use of low ESR ceramic capacitors.

Ultra-low ESR ceramic capacitors are recommended for output capacitance of 10 $\mu$ F or greater to help improve transient response and noise reduction at high frequency. X7R/X5R dielectric-type ceramic capacitors are recommended because of their temperature performance. X7R-type capacitors change capacitance by 15% over their operating temperature range and are the most stable type of ceramic capacitors. Z5U and Y5V dielectric capacitors change value by as much as 50% and 60% respectively over their operating temperature ranges. To use a ceramic chip capacitor with Y5V dielectric, the value must be much higher than a X7R ceramic capacitor to ensure the same minimum capacitance over the equivalent operating temperature range.

### Input Capacitor

An input capacitor of 1 $\mu$ F or greater is recommended when the device is more than four inches away from the bulk AC supply capacitance or when the supply is a battery. Small, surface mount, ceramic chip capacitors can be used for bypassing. Larger values will help to improve ripple rejection by bypassing the input to the regulator, further improving the integrity of the output voltage. Place the external capacitors for the input/output as close to the IC as possible. See Figure 1.

### Enable Input

The TMLF-6 (Thin MLF) and SOIC-8 package options feature an active-high enable input (EN) that allows for ON/OFF control of the regulator. Current drain reduces to “zero” when the device is shutdown, with only microamperes of leakage current. The EN input has TTL/CMOS compatible thresholds for simple logic interfacing. EN may be directly tied to  $V_{IN}$ .

### Transient Response and 3.3V to 2.5V or 2.5V to 1.8V, 1.65V or 1.5V Conversion

The MIC37110/02 and MIC37120/22 have excellent transient response to variations in input voltage and load current. The device has been designed to respond quickly to load current variations and input voltage variations. Large output capacitors are not required to obtain this performance. A standard 10 $\mu$ F output capacitor (ceramic) is all that is required. Larger values help to improve performance even further.

### Minimum Load Current

The MIC37112/22 regulator is specified between finite loads. If the output current is too small, leakage currents dominate and the output voltage rises. A 10mA minimum load current is necessary for proper regulation.

### Adjustable Regulator Design

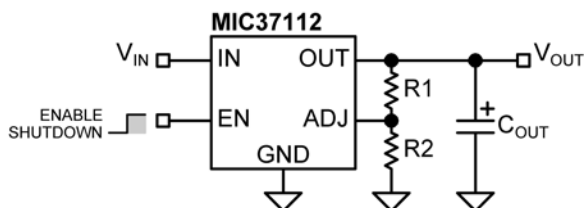

Figure 2. Adjustable Regulator with Resistors

The MIC37112 and MIC37122 allow programming the output voltage anywhere between 1.0V and 5.0V by placing a resistor divider network from OUT to GND and is determined by the following equation:

$$V_{OUT} = V_{ADJ} \times \left( \frac{R1}{R2} + 1 \right)$$

where:

$V_{OUT}$  is the desired output voltage and  $V_{ADJ} = 1.0V$ .

Two resistors are used. Resistors can be quite large, but the resistor ( $R1$ ) value between the OUT pin and the ADJ pin should not exceed 10k $\Omega$ . Larger values can cause instability.

The resistor values are calculated from the previous equation, resulting in the following:

$$R1 = R2 \times (V_{OUT} - 1)$$

Figure 2 shows component definition. Applications with widely varying load currents may scale the resistors to draw the minimum load current required for proper operation.

See Table 1 for a list of resistor combinations to set the output voltage. A 1% tolerance is recommended for both  $R1$  and  $R2$ .

$V_{OUT}$	$R1$	$R2$
1.0V	0	–
1.1V	10.0 $\Omega$	100 $\Omega$
1.2V	20.0 $\Omega$	100 $\Omega$
1.5V	49.9 $\Omega$	100 $\Omega$
1.8V	80.6 $\Omega$	100 $\Omega$
2.2V	121 $\Omega$	100 $\Omega$
2.5V	150 $\Omega$	100 $\Omega$
3.0V	200 $\Omega$	100 $\Omega$
3.3V	232 $\Omega$	100 $\Omega$
3.6V	261 $\Omega$	100 $\Omega$

Table 1. Resistor Selection for Specific  $V_{OUT}$

### Thermal Measurements

It is always wise to measure the IC's case temperature to make sure that it is within its operating limits. Although this might seem like a very elementary task, it is very easy to get erroneous results. The most common mistake is to use the standard thermal couple that comes with the thermal voltage meter. This thermal couple wire gauge is large, typically 22 gauge, and behaves like a heatsink, resulting in a lower case measurement.

There are two suggested methods for measuring the IC case temperature: a thermal couple or an infrared thermometer. If a thermal couple is used, it must be constructed of 36 gauge wire or higher to minimize the wire heatsinking effect. In addition, the thermal couple tip must be covered in either thermal grease or thermal glue to make sure that the thermal couple junction is making good contact to the case of the IC. This thermal couple from Omega (5SC-TT-K-36-36) is adequate for most applications.

To avoid this messy thermal couple grease or glue, an infrared thermometer is recommended. Most infrared thermometers' spot size is too large for an accurate reading on small form factor ICs. However, an IR thermometer from Optris has a 1mm spot size, which makes it ideal for the MIC371xx 2mm x 2mm Thin MLF package. Also, get the optional stand. The stand makes it easy to hold the beam on the IC for long periods of time.

### Power SOIC-8 Thermal Characteristics

One of the secrets of the MIC37110/37120's performance is its power SO-8 package featuring half the thermal resistance of a standard SO-8 package. Lower thermal resistance means more output current or higher input voltage for a given package size.

Lower thermal resistance is achieved by joining the four ground leads with the die attach paddle to create a single-piece electrical and thermal conductor. This concept has been used by MOSFET manufacturers for years, proving very reliable and cost effective for the user.

Thermal resistance consists of two main elements,  $\theta_{JC}$  (junction-to-case thermal resistance) and  $\theta_{CA}$  (case-to-ambient thermal resistance). See Figure 3.  $\theta_{JC}$  is the resistance from the die to the leads of the package.  $\theta_{CA}$  is the resistance from the leads to the ambient air and it includes  $\theta_{CS}$  (case-to-sink thermal resistance) and  $\theta_{SA}$  (sink-to-ambient thermal resistance).

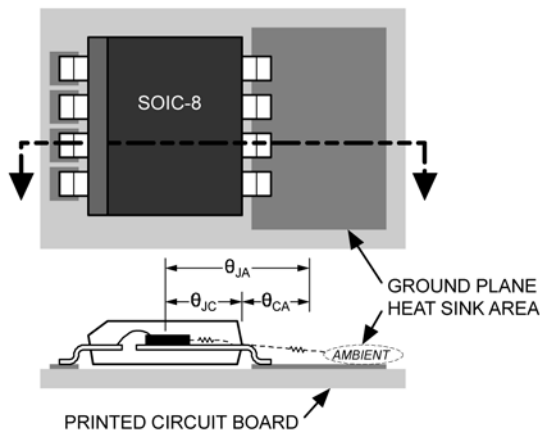

Figure 3. Thermal Resistance

Using the power SOIC-8 reduces the  $\theta_{JC}$  dramatically and allows the user to reduce  $\theta_{CA}$ . The total thermal resistance,  $\theta_{JA}$  (junction-to-ambient thermal resistance) is the limiting factor in calculating the maximum power dissipation capability of the device. Typically, the power SOIC-8 has a  $\theta_{JC}$  of 20°C/W, this is significantly lower than the standard SOIC-8 which is typically 75°C/W.  $\theta_{CA}$  is reduced because pins 5 through 8 can now be soldered directly to a ground plane which significantly reduces the case-to-sink thermal resistance and sinks to ambient thermal resistance.

Low-dropout linear regulators from Micrel are rated to a maximum junction temperature of 125°C. It is important not to exceed this maximum junction temperature during operation of the device. To prevent this maximum junction temperature from being exceeded, the appropriate ground plane heat sink must be used.

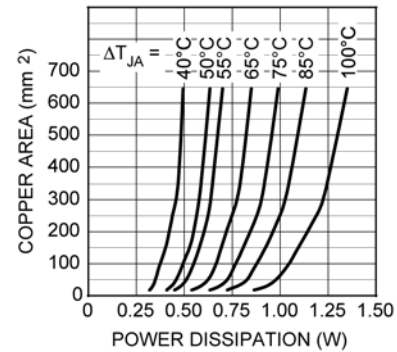

Figure 4. Copper Area vs. Power SO-8 Power Dissipation

Figure 4 shows copper area versus power dissipation with each trace corresponding to a different temperature rise above ambient.

From these curves, the minimum area of copper necessary for the part to operate safely can be determined. The maximum allowable temperature rise must be calculated to determine operation along which curve:

$$\Delta T = T_{J(max)} - T_{A(max)}$$

$$T_{J(max)} = 125^{\circ}\text{C}$$

$T_{A(max)}$  = maximum ambient operating temperature.

For example, the maximum ambient temperature is 50°C, the  $\Delta T$  is determined as follows:

$$\Delta T = 125^{\circ}\text{C} - 50^{\circ}\text{C}$$

$$\Delta T = 75^{\circ}\text{C}$$

Using Figure 4, the minimum amount of required copper can be determined based on the required power dissipation. Power dissipation in a linear regulator is calculated as follows:

$$P_D = (V_{IN} - V_{OUT}) I_{OUT} + V_{IN} \times I_{GND}$$



If we use a 2.5V output device and a 3.3V input at an output current of 1A, then our power dissipation is as follows:

$$P_D = (3.3V - 2.5V) \times 1A + 3.3V \times 11mA$$

$$P_D = 800mW + 36mW$$

$$P_D = 836mW$$

From Figure 4, the minimum amount of copper required to operate this application at a  $\Delta T$  of 75°C is 160mm<sup>2</sup>.

**Quick Method**

Determine the power dissipation requirements for the design along with the maximum ambient temperature at which the device will be operated. Refer to Figure 5, which shows safe operating curves for three different ambient temperatures: 25°C, 50°C and 85°C. From these curves, the minimum amount of copper can be determined by knowing the maximum power dissipation required. If the maximum ambient temperature is 50°C and the power dissipation is as above, 836mW, the curve in Figure 5 shows that the required area of copper is 160mm<sup>2</sup>.

The  $\theta_{JA}$  of this package is ideally 63°C/W, but it will vary depending upon the availability of copper ground plane to which it is attached.

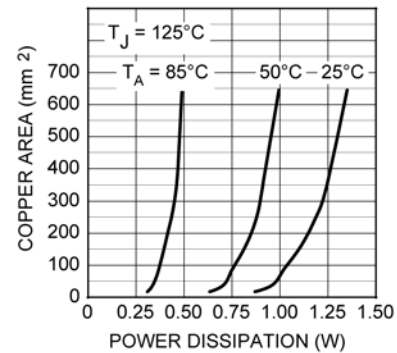
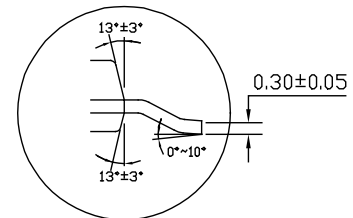
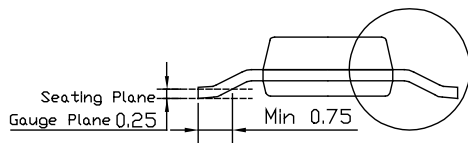
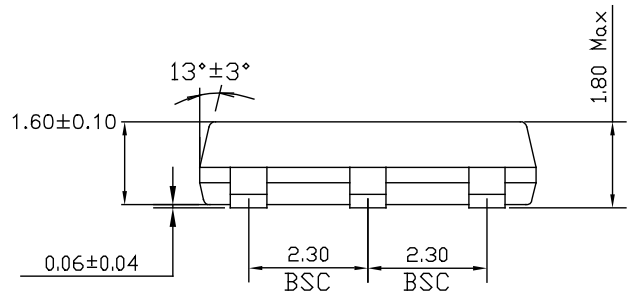
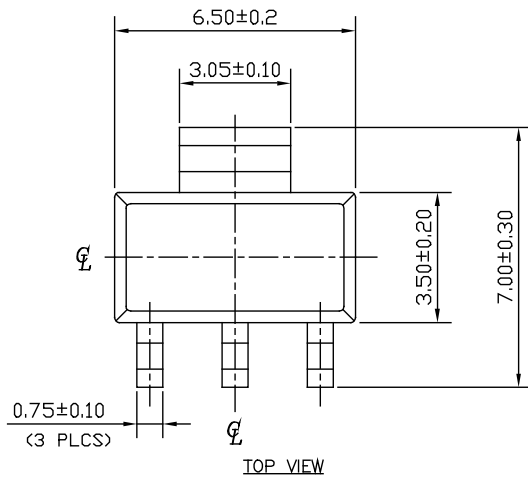

Figure 5. Copper Area vs. Power-SOIC Power Dissipation

## Package Information



**NOTE:**

1. Dimensions and tolerances are as per ANSI Y14.5M, 1982.
2. Controlling dimension: Millimeters.
3. Dimensions are exclusive of mold flash and gate burr.
4. All specification comply to Jedec spec TO261 Issue C.

**SOT-223 (S)**

Package Information (Continued)

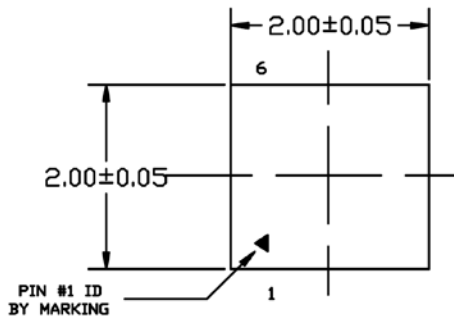

**TOP VIEW**  
NOTE: 1, 2, 3

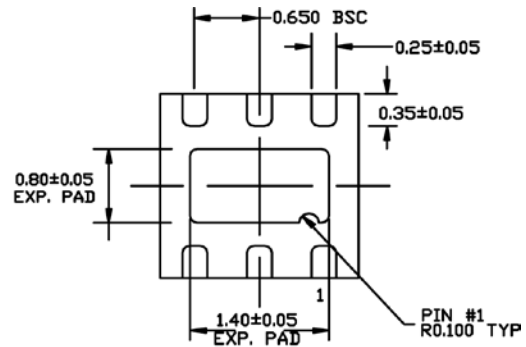

**BOTTOM VIEW**  
NOTE: 1, 2, 3

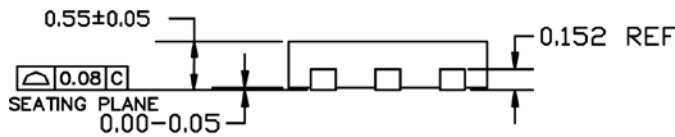

**END VIEW**  
NOTE: 1, 2, 3

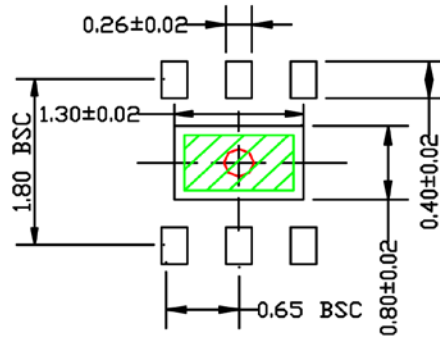

**RECOMMENDED LAND PATTERN**  
NOTE: 4, 5

NOTE:

1. MAX PACKAGE WARPAGE IS 0.08 MM
2. MAX ALLOWABLE BURR IS 0.076MM IN ALL DIRECTIONS
3. PIN #1 IS ON TOP WILL BE LASER MARKED
4. RED CIRCLE IN LAND PATTERN REPRESENTS THERMAL VIA. SIZE SHOULD BE 0.30-0.3 MM IN DIAMETER AND SHOULD BE CONNECTED TO GND FOR MAX THERMAL PERFORMANCE
5. GREEN RECTANGLES (SHADED AREA) REPRESENTS SOLDER STENCIL OPENING ON EXPOSED PAD AREA. SIZE SHOULD BE 1.10x0.60 MM.

6-Pin 2mm x 2mm Thin MLF (MT)

Package Information (Continued)

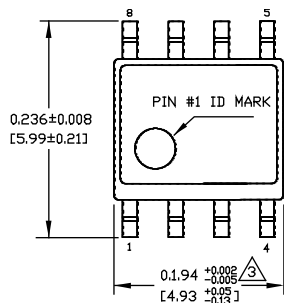

TOP VIEW

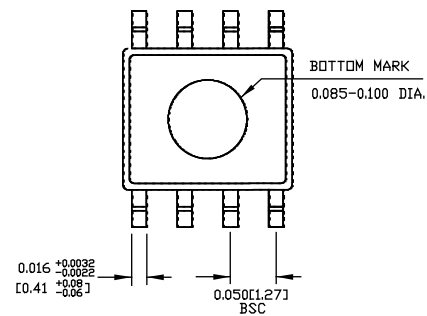

BOTTOM VIEW

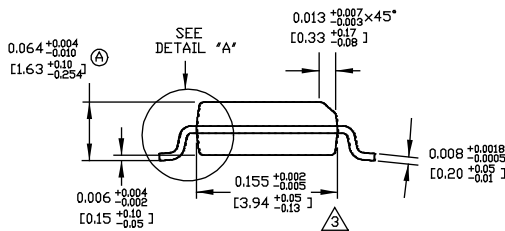

END VIEW

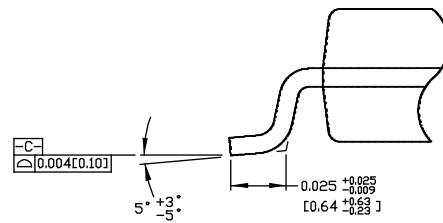

DETAIL "A"

NOTES:

1. DIMENSIONS ARE IN INCHES(MM).
2. CONTROLLING DIMENSION: INCHES.
3. DIMENSION DOES NOT INCLUDE MOLD FLASH OR PROTRUSIONS, EITHER OF WHICH SHALL NOT EXCEED 0.010[0.25] PER SIDE.

8-Pin SOIC (M)

MICREL, INC. 2180 FORTUNE DRIVE SAN JOSE, CA 95131 USA  
TEL +1 (408) 944-0800 FAX +1 (408) 474-1000 WEB <http://www.micrel.com>

Micrel makes no representations or warranties with respect to the accuracy or completeness of the information furnished in this data sheet. This information is not intended as a warranty and Micrel does not assume responsibility for its use. Micrel reserves the right to change circuitry, specifications and descriptions at any time without notice. No license, whether express, implied, arising by estoppel or otherwise, to any intellectual property rights is granted by this document. Except as provided in Micrel's terms and conditions of sale for such products, Micrel assumes no liability whatsoever, and Micrel disclaims any express or implied warranty relating to the sale and/or use of Micrel products including liability or warranties relating to fitness for a particular purpose, merchantability, or infringement of any patent, copyright or other intellectual property right.

Micrel Products are not designed or authorized for use as components in life support appliances, devices or systems where malfunction of a product can reasonably be expected to result in personal injury. Life support devices or systems are devices or systems that (a) are intended for surgical implant into the body or (b) support or sustain life, and whose failure to perform can be reasonably expected to result in a significant injury to the user. A Purchaser's use or sale of Micrel Products for use in life support appliances, devices or systems is a Purchaser's own risk and Purchaser agrees to fully indemnify Micrel for any damages resulting from such use or sale.

# Mouser Electronics

Authorized Distributor

Click to View Pricing, Inventory, Delivery & Lifecycle Information:

[Micrel:](#)

[MIC37112YM](#) [MIC37110-1.8YMT TR](#) [MIC37112YMT TR](#) [MIC37110-1.8YM TR](#) [MIC37110-1.8YS TR](#) [MIC37120-1.8YMT TR](#) [MIC37122YM TR](#) [MIC37112YM TR](#) [MIC37122YMT TR](#)