



MIC5501/2/3/4

Single 300mA LDO
in 1.0mm × 1.0mm DFN Package

General Description

The MIC5501/2/3/4 is an advanced general-purpose LDO ideal for powering general-purpose portable devices. The MIC5501/2/3/4 family of products provides a high-performance 300mA LDO in an ultra-small 1mm × 1mm package. The MIC5502 and MIC5504 LDOs include an auto-discharge feature on the output that is activated when the enable pin is low. The MIC5503 and MIC5504 have an internal pull-down resistor on the enable pin that disables the output when the enable pin is left floating. This is ideal for applications where the control signal is floating during processor boot up.

Ideal for battery-powered applications, the MIC5501/2/3/4 offers 2% initial accuracy, low dropout voltage (160mV at 300mA), and low ground current (typically 38 μ A). The MIC5501/2/3/4 can also be put into a zero-off-mode current state, drawing virtually no current when disabled.

The MIC5501/2/3/4 has an operating junction temperature range of -40°C to 125°C .

Datasheets and support documentation can be found on Micrel's web site at: www.micrel.com.

Features

- Input voltage range: 2.5V to 5.5V
- Fixed output voltages from 1.0V to 3.3V
- 300mA guaranteed output current
- High output accuracy ($\pm 2\%$)
- Low quiescent current: 38 μ A
- Stable with 1 μ F ceramic output capacitors
- Low dropout voltage: 160mV @ 300mA
- Output discharge circuit: MIC5502, MIC5504
- Internal enable pull-down: MIC5503, MIC5504
- Thermal-shutdown and current-limit protection
- 4-lead 1.0mm × 1.0mm Thin DFN package
- MIC5504 5-pin SOT23 package

Applications

- Smartphones
- DSC, GPS, PMP, and PDAs
- Medical devices
- Portable electronics
- 5V systems

Typical Application

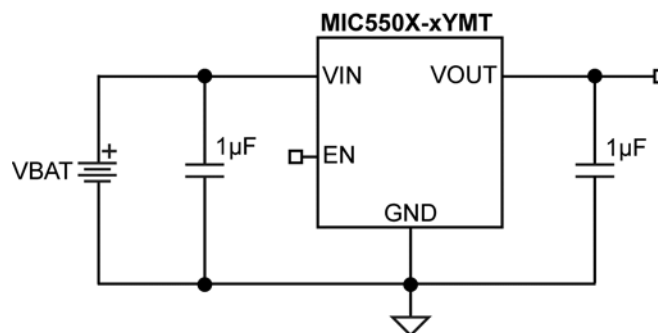

Ordering Information

Part Number	Marking Code	Output Voltage ⁽¹⁾	Auto-Discharge	EN Pull-Down	Temperature Range	Package ^(2,3)
MIC5501-3.3YMT ⁽⁴⁾	VS	3.3V	NO	NO	-40°C to +125°C	4-Pin 1mm x 1mm Thin DFN
MIC5501-3.0YMT	VP	3.0V	NO	NO	-40°C to +125°C	4-Pin 1mm x 1mm Thin DFN
MIC5501-2.8YMT ⁽⁴⁾	VM	2.8V	NO	NO	-40°C to +125°C	4-Pin 1mm x 1mm Thin DFN
MIC5501-1.8YMT	VG	1.8V	NO	NO	-40°C to +125°C	4-Pin 1mm x 1mm Thin DFN
MIC5501-1.2YMT ⁽⁴⁾	V4	1.2V	NO	NO	-40°C to +125°C	4-Pin 1mm x 1mm Thin DFN
MIC5501-3.0YM5	VX	3.0V	NO	NO	-40°C to +125°C	5-Pin SOT23
MIC5502-3.3YMT ⁽⁴⁾	XS	3.3V	YES	NO	-40°C to +125°C	4-Pin 1mm x 1mm Thin DFN
MIC5502-3.0YMT ⁽⁴⁾	XP	3.0V	YES	NO	-40°C to +125°C	4-Pin 1mm x 1mm Thin DFN
MIC5502-2.8YMT	XM	2.8V	YES	NO	-40°C to +125°C	4-Pin 1mm x 1mm Thin DFN
MIC5502-1.8YMT	XG	1.8V	YES	NO	-40°C to +125°C	4-Pin 1mm x 1mm Thin DFN
MIC5502-1.2YMT ⁽⁴⁾	X4	1.2V	YES	NO	-40°C to +125°C	4-Pin 1mm x 1mm Thin DFN
MIC5503-3.3YMT ⁽⁴⁾	SV	3.3V	NO	YES	-40°C to +125°C	4-Pin 1mm x 1mm Thin DFN
MIC5503-3.0YMT ⁽⁴⁾	ZV	3.0V	NO	YES	-40°C to +125°C	4-Pin 1mm x 1mm Thin DFN
MIC5503-2.8YMT ⁽⁴⁾	MV	2.8V	NO	YES	-40°C to +125°C	4-Pin 1mm x 1mm Thin DFN
MIC5503-1.8YMT	YV	1.8V	NO	YES	-40°C to +125°C	4-Pin 1mm x 1mm Thin DFN
MIC5503-1.2YMT ⁽⁴⁾	XV	1.2V	NO	YES	-40°C to +125°C	4-Pin 1mm x 1mm Thin DFN
MIC5504-3.3YMT	SX	3.3V	YES	YES	-40°C to +125°C	4-Pin 1mm x 1mm Thin DFN
MIC5504-3.1YMT	TX	3.1V	YES	YES	-40°C to +125°C	4-Pin 1mm x 1mm Thin DFN
MIC5504-3.0YMT	PX	3.0V	YES	YES	-40°C to +125°C	4-Pin 1mm x 1mm Thin DFN
MIC5504-2.8YMT	MX	2.8V	YES	YES	-40°C to +125°C	4-Pin 1mm x 1mm Thin DFN
MIC5504-2.5YMT	UX	2.5V	YES	YES	-40°C to +125°C	4-Pin 1mm x 1mm Thin DFN
MIC5504-2.2YMT	UW	2.2V	YES	YES	-40°C to +125°C	4-Pin 1mm x 1mm Thin DFN
MIC5504-1.8YMT	GX	1.8V	YES	YES	-40°C to +125°C	4-Pin 1mm x 1mm Thin DFN
MIC5504-1.2YMT	ZX	1.2V	YES	YES	-40°C to +125°C	4-Pin 1mm x 1mm Thin DFN
MIC5504-3.3YM5	WXS	3.3V	YES	YES	-40°C to +125°C	5-Pin SOT23
MIC5504-2.8YM5	WXM	2.8V	YES	YES	-40°C to +125°C	5-Pin SOT23
MIC5504-2.5YM5	WXJ	2.5V	YES	YES	-40°C to +125°C	5-Pin SOT23
MIC5504-1.8YM5	WXG	1.8V	YES	YES	-40°C to +125°C	5-Pin SOT23
MIC5504-1.2YM5	WX4	1.2V	YES	YES	-40°C to +125°C	5-Pin SOT23

Notes:

1. Other voltages available. Contact Micrel for details.
2. Thin DFN ▲ = Pin 1 identifier.
3. Thin DFN is a GREEN RoHS-compliant package. Lead finish is NiPdAu. Mold compound is Halogen Free.
4. Contact Micrel Marketing for availability.

Pin Configuration

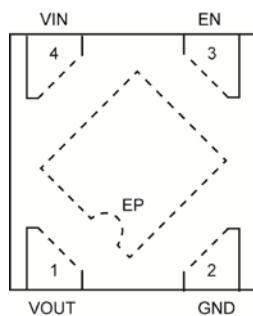

4-Pin 1mm x 1mm Thin DFN (MT)
(Top View)

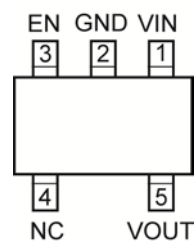

5-Pin SOT23 (M5)
(Top View)

Pin Description

Pin Name	Pin Number Thin DFN-4	Pin Number SOT23-5	Pin Function
VOUT	1	5	Output Voltage. When disabled the MIC5502 and MIC5504 switches in an internal 25Ω load to discharge the external capacitors.
GND	2	2	Ground
EN	3	3	Enable Input: Active High. High = ON; Low = OFF. For MIC5501 and MIC5502 do not leave floating. MIC5503 and MIC5504 have an internal pull-down and this pin may be left floating.
VIN	4	1	Supply Input.
NC	-	4	No Connection. Pin is not internally connected.
ePad	EP	-	Exposed Heatsink Pad. Connect to GND for best thermal performance.

Absolute Maximum Ratings⁽⁵⁾

Supply Voltage (V_{IN})	-0.3V to 6V
Enable Voltage (V_{EN})	-0.3V to V_{IN}
Power Dissipation (P_D)	Internally Limited ⁽⁷⁾
Lead Temperature (soldering, 10s)	260°C
Junction Temperature (T_J)	-40°C to +150°C
Storage Temperature (T_S)	-65°C to +150°C
ESD Rating ⁽⁸⁾	3kV

Operating Ratings⁽⁶⁾

Supply Voltage (V_{IN})	2.5V to 5.5V
Enable Voltage (V_{EN})	0V to V_{IN}
Junction Temperature (T_J)	-40°C to +125°C
Junction Thermal Resistance	
1mm x 1mm Thin DFN-4 (θ_{JA})	250°C/W
5-pin SOT23 (θ_{JA})	253°C/W

Electrical Characteristics⁽⁹⁾

$V_{IN} = V_{EN} = V_{OUT} + 1V$; $C_{IN} = C_{OUT} = 1\mu F$; $I_{OUT} = 100\mu A$; $T_J = 25^\circ C$, **bold** values indicate -40°C to +125°C, unless noted.

Parameter	Condition	Min.	Typ.	Max.	Units
Output Voltage Accuracy	Variation from nominal V_{OUT}	-2.0		+2.0	%
	Variation from nominal V_{OUT} ; -40°C to +125°C	-3.0		+3.0	%
Line Regulation	$V_{IN} = V_{OUT} + 1V$ to 5.5V; $I_{OUT} = 100\mu A$		0.02	0.3	%/V
Load Regulation ⁽¹⁰⁾	$I_{OUT} = 100\mu A$ to 300mA		8	40	mV
Dropout Voltage ⁽¹¹⁾	$I_{OUT} = 150mA$		80	190	mV
	$I_{OUT} = 300mA$		160	380	mV
Ground Pin Current ⁽¹²⁾	$I_{OUT} = 0mA$		38	55	μA
	$I_{OUT} = 300mA$		42	65	μA
Ground Pin Current in Shutdown	$V_{EN} = 0V$		0.05	1	μA
Ripple Rejection	$f = 1kHz$; $C_{OUT} = 1\mu F$		60		dB
Current Limit	$V_{OUT} = 0V$	400	630	900	mA
Output Voltage Noise	$C_{OUT} = 1\mu F$, 10Hz to 100kHz		175		μV_{RMS}
Auto-Discharge NFET Resistance	MIC5502, MIC5504 Only; $V_{EN} = 0V$; $V_{IN} = 3.6V$; $I_{OUT} = -3mA$		25		Ω
Enable Input					
Enable Pull-Down Resistor	For MIC5503 and MIC5504 use only		4		M Ω
Enable Input Voltage	Logic Low			0.2	V
	Logic High	1.2			V
Enable Input Current MIC5501, MIC5502	$V_{EN} = 0V$		0.01	1	μA
	$V_{EN} = 5.5V$		0.01	1	μA
Enable Input Current MIC5503, MIC5504	$V_{EN} = 0V$		0.01	1	μA
	$V_{EN} = 5.5V$		1.4	2	μA
Turn-On Time	$C_{OUT} = 1\mu F$; $I_{OUT} = 150mA$		50	125	μs

Notes:

- Exceeding the absolute maximum rating may damage the device.
- The device is not guaranteed to function outside its operating rating.
- The maximum allowable power dissipation of any T_A (ambient temperature) is $P_{D(max)} = (T_{J(max)} - T_A) / \theta_{JA}$. Exceeding the maximum allowable power dissipation will result in excessive die temperature, and the regulator will go into thermal shutdown.
- Devices are ESD sensitive. Handling precautions are recommended. Human body model, 1.5k Ω in series with 100pF.
- Specification for packaged product only.
- Regulation is measured at constant junction temperature using low duty cycle pulse testing. Changes in output voltage due to heating effects are covered by the thermal regulation specification.
- Dropout voltage is defined as the input-to-output differential at which the output voltage drops 2% below its nominal value measured at 1V differential. For outputs below 2.5V, dropout voltage is the input-to-output differential with the minimum input voltage 2.5V.
- Ground pin current is the regulator quiescent current. The total current drawn from the supply is the sum of the load current plus the ground pin current.

Typical Characteristics

Power Supply Rejection Ratio

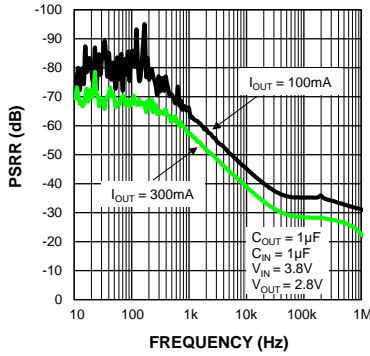

Dropout Voltage vs. Output Current

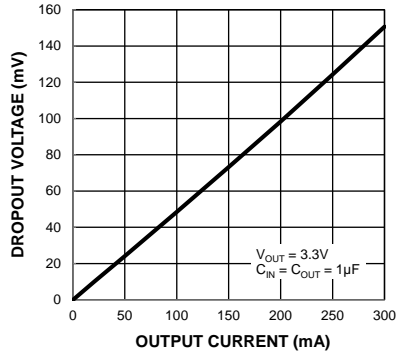

Dropout Voltage vs. Temperature

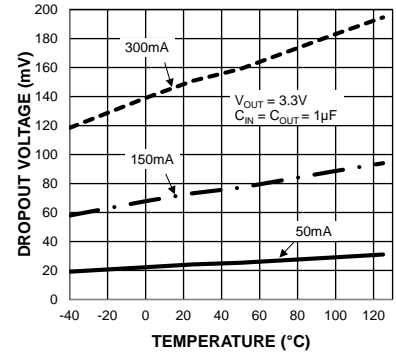

Ground Current vs. Supply Voltage

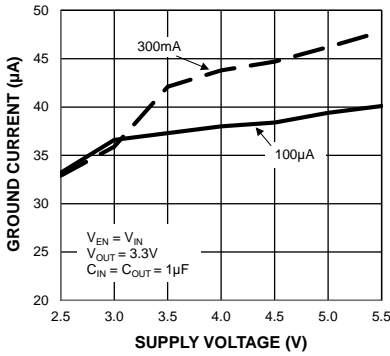

Ground Current vs. Load Current

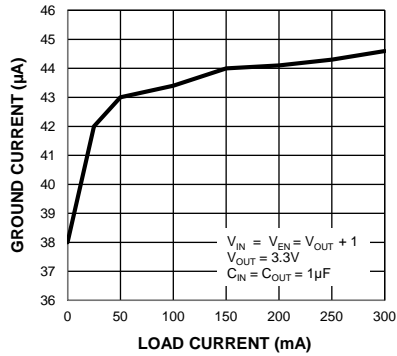

Ground Current vs. Temperature

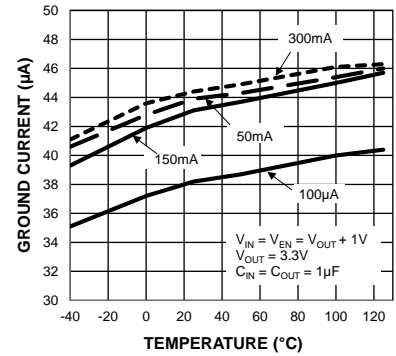

Output Voltage vs. Output Current

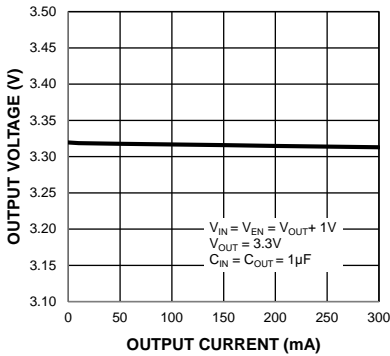

Output Voltage vs. Supply Voltage

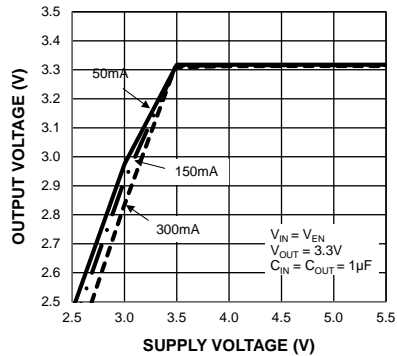

Output Voltage vs. Temperature

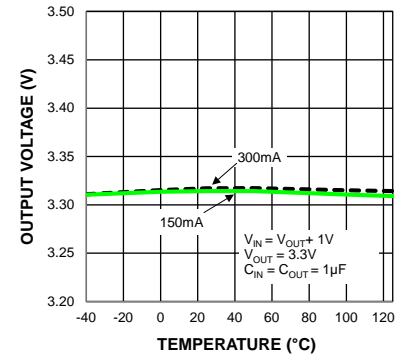

Typical Characteristics (Continued)

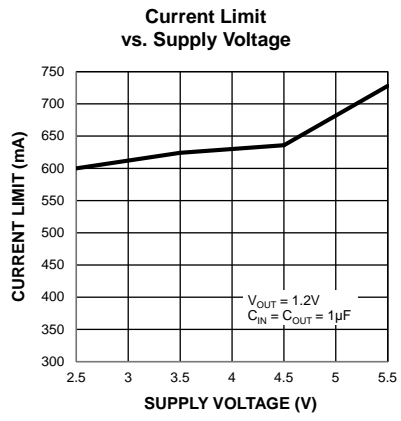

Functional Characteristics

Enable Turn-On

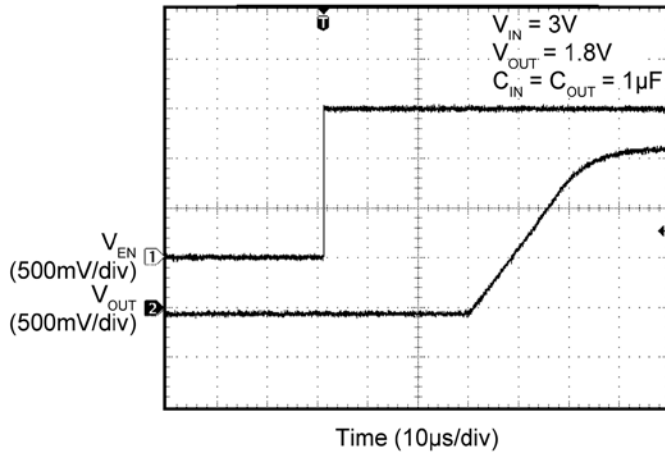

Enable Turn-On

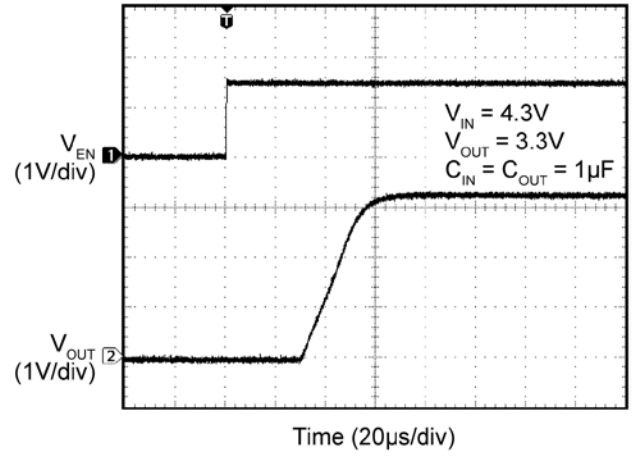

Load Transient

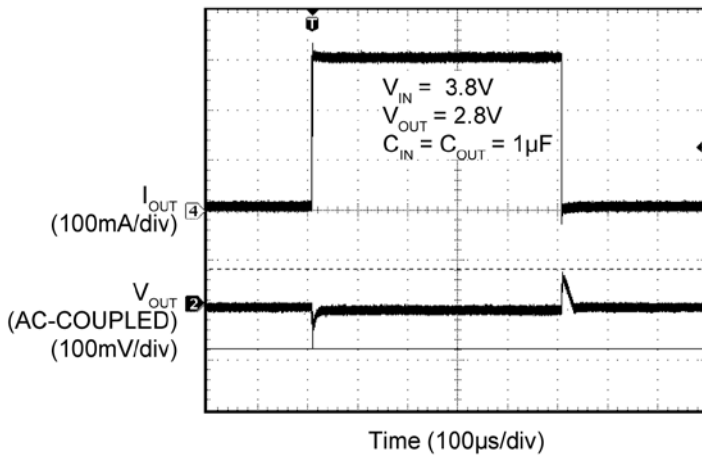

Load Transient

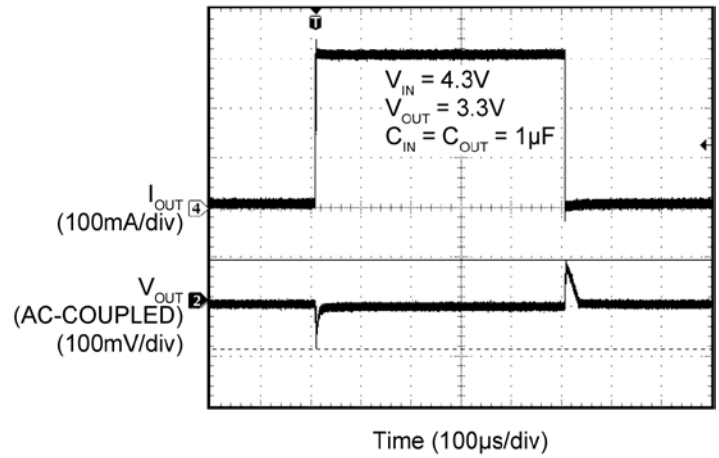

Line Transient

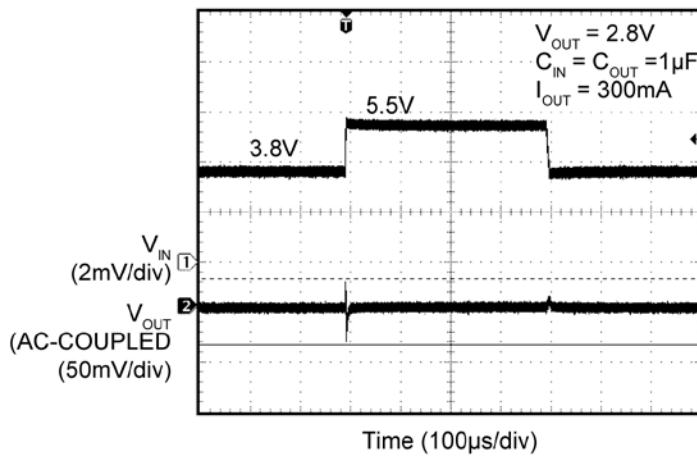

Auto Discharge (No Load)

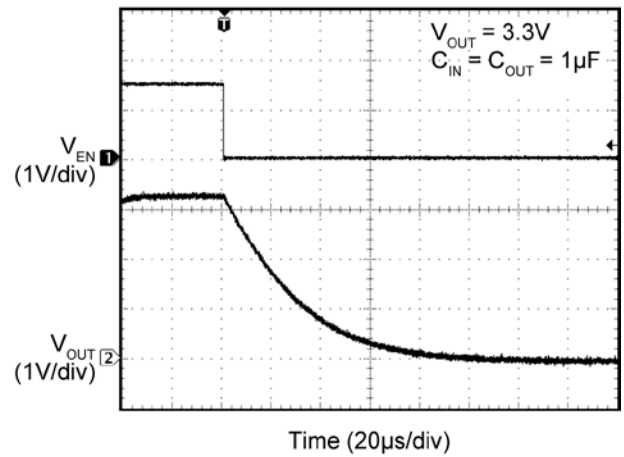

Block Diagram

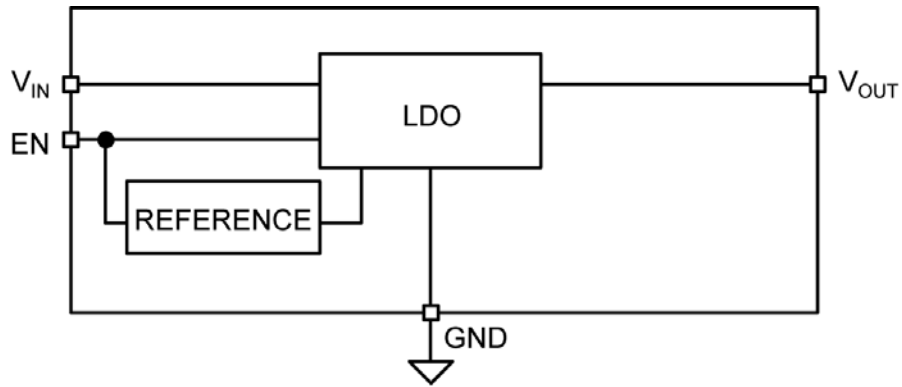

MIC550x Block Diagram

Application Information

MIC5501/2/3/4 are low-noise 300mA LDOs. The MIC5502 and MIC5504 include an auto-discharge circuit that is switched on when the regulator is disabled through the enable (EN) pin. The MIC5503 and MIC5504 have an internal pull-down resistor on the EN pin to ensure the output is disabled if the control signal is tri-stated. The MIC5501/2/3/4 regulator is fully protected from damage due to fault conditions, offering linear current limiting and thermal shutdown.

Input Capacitor

The MIC5501/2/3/4 is a high-performance, high-bandwidth device. An input capacitor of 1 μ F is required from the input to ground to provide stability. Low-ESR ceramic capacitors provide optimal performance at a minimum of space. Additional high-frequency capacitors, such as small-valued NPO dielectric-type capacitors, help filter out high-frequency noise and are good practice in any RF-based circuit. X5R or X7R dielectrics are recommended for the input capacitor. Y5V dielectrics lose most of their capacitance over temperature and are therefore, not recommended.

Output Capacitor

The MIC5501/2/3/4 requires an output capacitor of 1 μ F or greater to maintain stability. The design is optimized for use with low-ESR ceramic chip capacitors. High ESR capacitors are not recommended because they may cause high-frequency oscillation. The output capacitor can be increased, but performance has been optimized for a 1 μ F ceramic output capacitor and does not improve significantly with larger capacitance.

X7R/X5R dielectric-type ceramic capacitors are recommended because of their temperature performance. X7R-type capacitors change capacitance by 15% over their operating temperature range and are the most stable type of ceramic capacitors. Z5U and Y5V dielectric capacitors change value by as much as 50% and 60%, respectively, over their operating temperature ranges. To use a ceramic chip capacitor with Y5V dielectric, the value must be much higher than an X7R ceramic capacitor to ensure the same minimum capacitance over the equivalent operating temperature range.

No-Load Stability

Unlike many other voltage regulators, the MIC5501/2/3/4 remains stable and in regulation with no load. This is especially important in CMOS RAM keep-alive applications.

Enable/Shutdown

The MIC5501/2/3/4 comes with an active-high enable pin that allows the regulator to be disabled. Forcing the EN pin low disables the regulator and sends it into an off mode current state drawing virtually zero current. When disabled the MIC5502 and MIC5504 switches an internal 25 Ω load on the regulator output to discharge the external capacitor.

Forcing the EN pin high enables the output voltage. The MIC5501 and MIC5502 enable pin uses CMOS technology and the EN pin cannot be left floating; a floating EN pin may cause an indeterminate state on the output. The MIC5503 and MIC5504 have an internal pull-down resistor on the enable pin to disable the output when the enable pin is floating.

Thermal Considerations

The MIC5501/2/3/4 is designed to provide 300mA of continuous current in a very small package. Maximum ambient operating temperature can be calculated based on the output current and the voltage drop across the part. For example if the input voltage is 3.6V, the output voltage is 2.8V, and the output current = 300mA. The actual power dissipation of the regulator circuit can be determined using Equation 1:

$$P_D = (V_{IN} - V_{OUT1}) I_{OUT} + V_{IN} I_{GND} \quad \text{Eq. 1}$$

Because this device is CMOS and the ground current is typically <100 μ A over the load range, the power dissipation contributed by the ground current is < 1% and can be ignored for this calculation:

$$P_D = (3.6V - 2.8V) \times 300mA$$

$$P_D = 0.240W$$

To determine the maximum ambient operating temperature of the package, use the junction-to-ambient thermal resistance of the device and Equation 2:

$$P_{D(max)} = \left(\frac{T_{J(max)} - T_A}{\theta_{JA}} \right) \quad \text{Eq. 2}$$

$T_{J(max)} = 125^\circ\text{C}$, the maximum junction temperature of the die, θ_{JA} thermal resistance = 250 $^\circ\text{C/W}$ for the DFN package.

Substituting P_D for $P_{D(max)}$ and solving for the ambient operating temperature will give the maximum operating conditions for the regulator circuit. The junction-to-ambient thermal resistance for the minimum footprint is $250^{\circ}\text{C}/\text{W}$.

The maximum power dissipation must not be exceeded for proper operation.

For example, when operating the MIC5501-MYMT at an input voltage of 3.6V and 300mA load with a minimum footprint layout, the maximum ambient operating temperature T_A can be determined as follows:

$$0.240\text{W} = (125^{\circ}\text{C} - T_A)/(250^{\circ}\text{C}/\text{W})$$

$$T_A = 65^{\circ}\text{C}$$

Therefore, the maximum ambient operating temperature allowed in a 1mm x 1mm DFN package is 65°C . For a full discussion of heat sinking and thermal effects on voltage regulators, refer to the "Regulator Thermals" section of *Micrel's Designing with Low-Dropout Voltage Regulators* handbook. This information can be found on Micrel's website at:

http://www.micrel.com/_PDF/other/LDOBk_ds.pdf

Typical Application

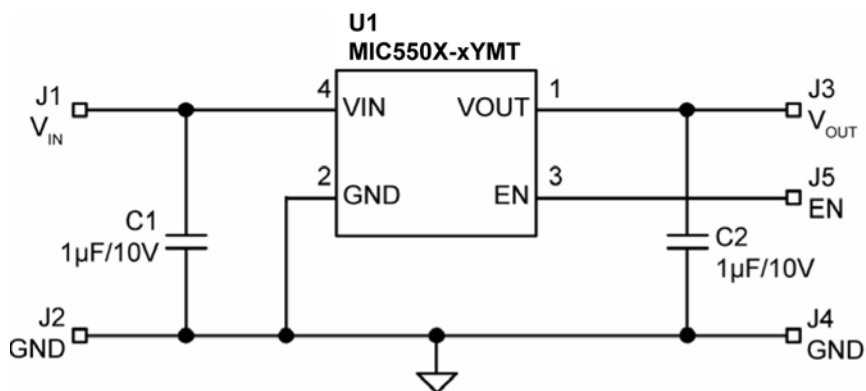

Bill of Materials

Item	Part Number	Manufacturer	Description	Qty.
C1, C2	GRM155R61A105KE15D	Murata ⁽¹³⁾	Capacitor, 1µF Ceramic, 10V, X5R, Size 0402	2
U1	MIC5501-xYMT	Micrel, Inc. ⁽¹⁴⁾	Single 300mA LDO in 1.0mm × 1.0mm DFN Package	1
	MIC5502-xYMT			
	MIC5503-xYMT			
	MIC5504-xYMT			

Notes:

13. Murata: www.murata.com.

14. Micrel, Inc.: www.micrel.com.

PCB Layout Recommendations (1mm x 1mm Thin DFN)

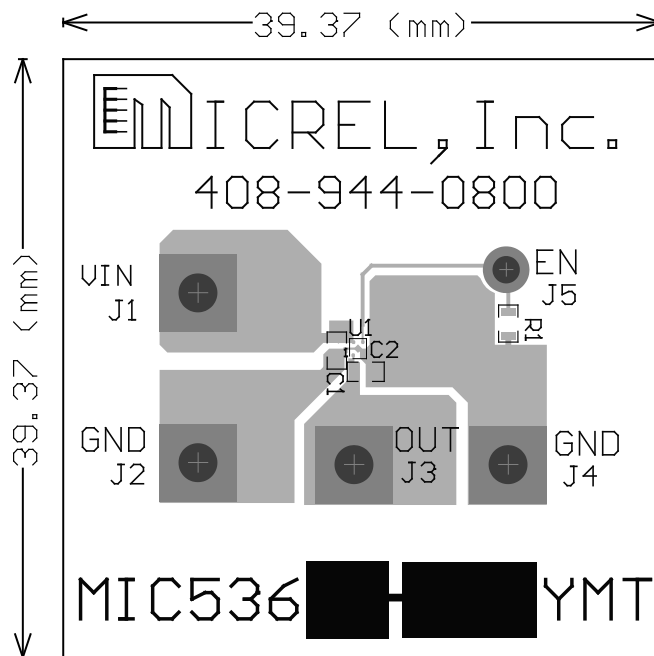

Top Layer

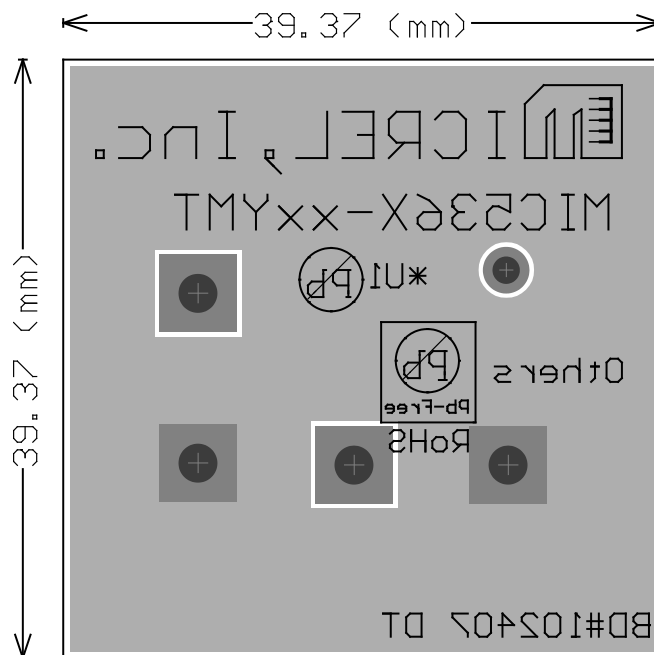

Bottom Layer

Package Information⁽¹⁵⁾ and Recommended Landing Pattern

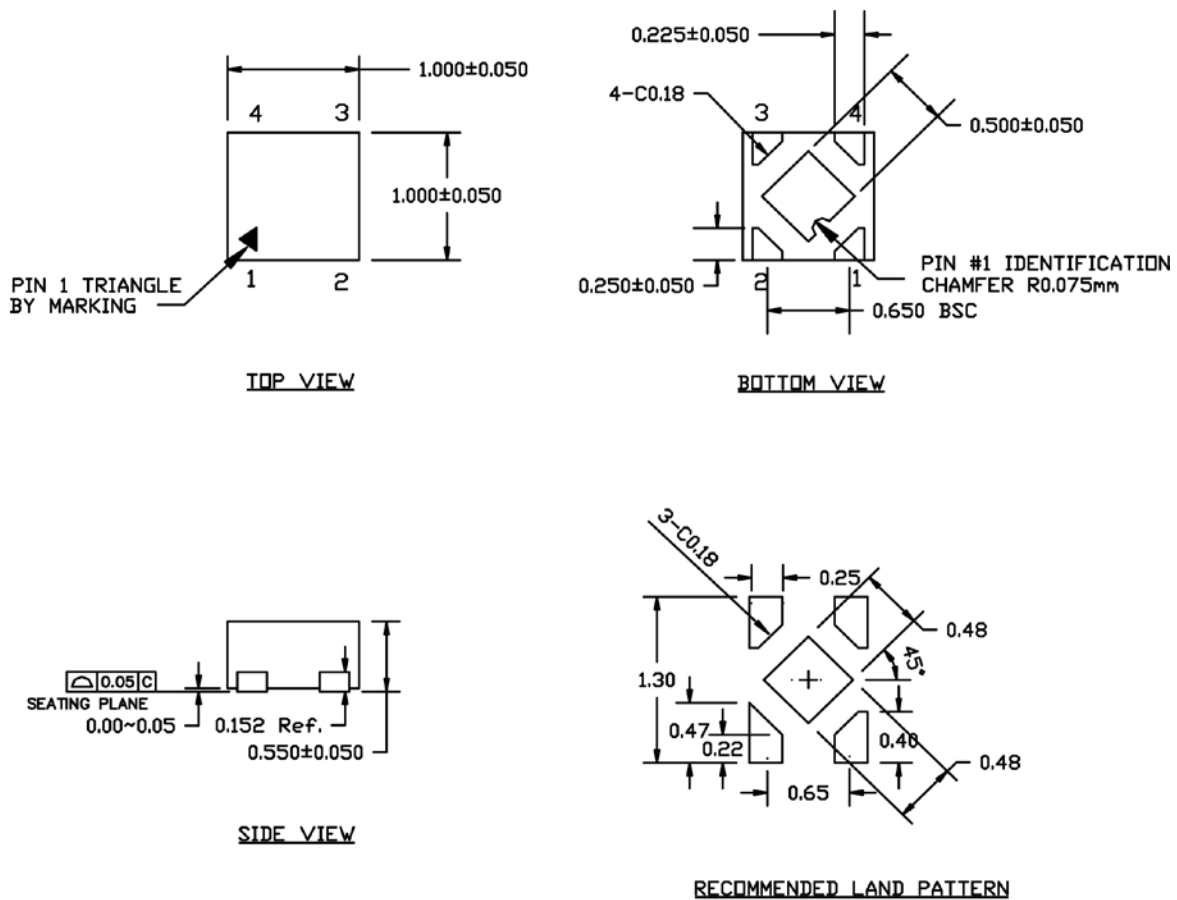

- NOTE:
1. MAX PACKAGE WARPAGE IS 0.05 MM
 2. MAX ALLOWABLE BURR IS 0.076MM IN ALL DIRECTIONS
 3. PIN #1 IS ON TOP WILL BE LASER MARKED
 4. UNSPECIFIED TOLERANCE IS +/- 0.05 MM

4-Pin 1mm x 1mm Thin DFN (MT)

Note:

15. Package information is correct as of the publication date. For updates and most current information, go to www.micrel.com.

Package Information⁽¹⁵⁾ and Recommended Landing Pattern (Continued)

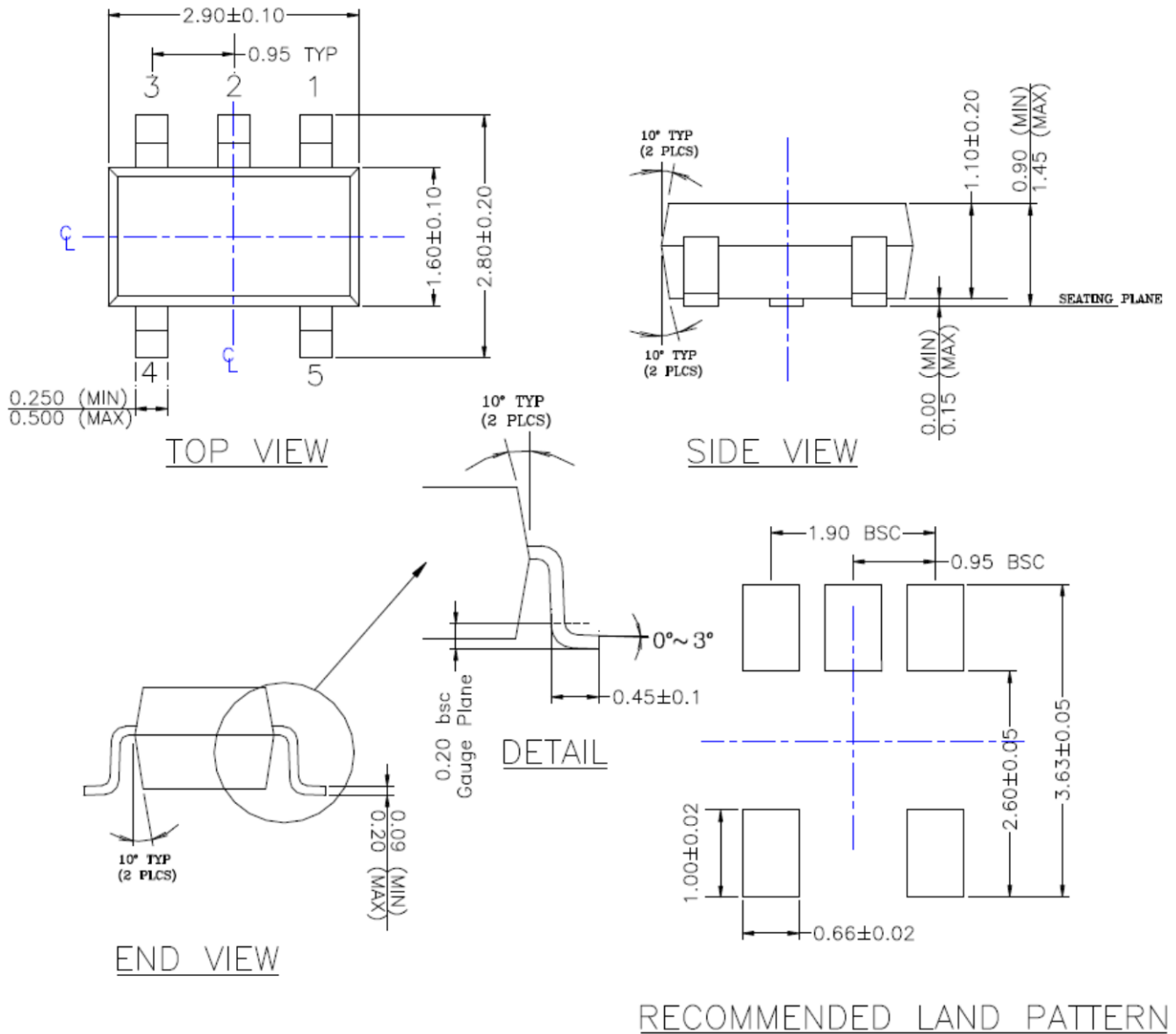

- NOTE:
1. PACKAGE OUTLINE EXCLUSIVE OF MOLD FLASH & BURR.
 2. PACKAGE OUTLINE INCLUSIVE OF SOLER PLATING.
 3. DIMENSION AND TOLERANCE PER ANSI Y14.5M, 1982.
 4. FOOT LENGTH MEASUREMENT BASED ON GAUGE PLANE METHOD.
 5. DIE FACES UP FOR MOLD, AND FACES DOWN FOR TRIM/FORM.
 6. ALL DIMENSIONS ARE IN MILLIMETERS.

5-Pin SOT23 (M5)

MICREL, INC. 2180 FORTUNE DRIVE SAN JOSE, CA 95131 USA
TEL +1 (408) 944-0800 FAX +1 (408) 474-1000 WEB <http://www.micrel.com>

Micrel, Inc. is a leading global manufacturer of IC solutions for the worldwide high performance linear and power, LAN, and timing & communications markets. The Company's products include advanced mixed-signal, analog & power semiconductors; high-performance communication, clock management, MEMs-based clock oscillators & crystal-less clock generators, Ethernet switches, and physical layer transceiver ICs. Company customers include leading manufacturers of enterprise, consumer, industrial, mobile, telecommunications, automotive, and computer products. Corporation headquarters and state-of-the-art wafer fabrication facilities are located in San Jose, CA, with regional sales and support offices and advanced technology design centers situated throughout the Americas, Europe, and Asia. Additionally, the Company maintains an extensive network of distributors and reps worldwide.

Micrel makes no representations or warranties with respect to the accuracy or completeness of the information furnished in this datasheet. This information is not intended as a warranty and Micrel does not assume responsibility for its use. Micrel reserves the right to change circuitry, specifications and descriptions at any time without notice. No license, whether express, implied, arising by estoppel or otherwise, to any intellectual property rights is granted by this document. Except as provided in Micrel's terms and conditions of sale for such products, Micrel assumes no liability whatsoever, and Micrel disclaims any express or implied warranty relating to the sale and/or use of Micrel products including liability or warranties relating to fitness for a particular purpose, merchantability, or infringement of any patent, copyright, or other intellectual property right.

Micrel Products are not designed or authorized for use as components in life support appliances, devices or systems where malfunction of a product can reasonably be expected to result in personal injury. Life support devices or systems are devices or systems that (a) are intended for surgical implant into the body or (b) support or sustain life, and whose failure to perform can be reasonably expected to result in a significant injury to the user. A Purchaser's use or sale of Micrel Products for use in life support appliances, devices or systems is a Purchaser's own risk and Purchaser agrees to fully indemnify Micrel for any damages resulting from such use or sale.

© 2012 Micrel, Incorporated.

Mouser Electronics

Authorized Distributor

Click to View Pricing, Inventory, Delivery & Lifecycle Information:

Micrel:

[MIC5504-3.3YMT TZ](#) [MIC5501-1.8YMT T5](#) [MIC5501-1.8YMT TZ](#) [MIC5502-1.8YMT T5](#) [MIC5502-1.8YMT TZ](#)
[MIC5504-3.3YMT TR](#) [MIC5504-3.3YM5 TR](#) [MIC5502-2.8YMT TR](#) [MIC5502-1.8YMT TR](#) [MIC5504-2.2YMT TZ](#)
[MIC5504-3.1YMT TR](#) [MIC5501-3.0YMT TR](#) [MIC5501-1.8YMT TR](#) [MIC5504-2.2YMT TR](#) [MIC5504-1.2YMT TR](#)
[MIC5504-2.8YMT TR](#) [MIC5504-3.0YMT TR](#) [MIC5504-2.8YM5 TR](#) [MIC5504-1.8YMT TR](#) [MIC5504-2.2YMT T5](#)
[MIC5504-3.3YM5 T5](#) [MIC5504-2.8YM5 T5](#) [MIC5503-1.8YMT TR](#) [MIC5504-2.5YM5 TR](#) [MIC5504-1.2YM5 TR](#)
[MIC5504-1.2YM5 T5](#) [MIC5504-1.8YM5 T5](#) [MIC5504-1.8YM5 TR](#) [MIC5504-2.5YMT TR](#) [MIC5501-3.0YM5 TR](#)