

MMIC Silicon Bipolar Broadband Amplifier

ISL55015

The ISL55015 is a high performance gain block featuring a Darlington configuration using high f_T transistors and excellent thermal performance. They are an ideal choice for DVB-S LNB cable receiver applications.

Other members of the family include:

- ISL55012 and ISL55015 match a 75Ω source to a 50Ω load
- ISL55013 and ISL55014 match a 50Ω source to a 50Ω load

Ordering Information

PART NUMBER (Notes 1, 2, 3)	PART MARKING	PACKAGE (Pb-Free)	PKG. DWG. #
ISL55015IEZ-T7	CCK	6 Ld SC-70	P6.049B

NOTES:

1. Please refer to [TB347](#) for details on reel specifications.
2. These Intersil Pb-free plastic packaged products employ special Pb-free material sets, molding compounds/die attach materials, and 100% matte tin plate plus anneal (e3 termination finish, which is RoHS compliant and compatible with both SnPb and Pb-free soldering operations). Intersil Pb-free products are MSL classified at Pb-free peak reflow temperatures that meet or exceed the Pb-free requirements of IPC/JEDEC J STD-020.
3. For Moisture Sensitivity Level (MSL), please see device information page for [ISL55015](#). For more information on MSL please see techbrief [TB363](#).

Features

- Input impedance of 75Ω
- Output impedance of 50Ω
- Gain of 13.5dB @1GHz
- Noise figure of 4.8dB @2GHz
- OIP3 of 31dBm @1GHz
- Low input and output return losses
- Pb-free (RoHS compliant)

Applications

- LNB and LNB-T (HDTV) amplifiers
- IF gain blocks for satellite and terrestrial STBs
- PA driver amplifier
- Wireless data, satellite
- Bluetooth/WiFi
- Satellite locator and signal strength meters

Typical Application Circuit

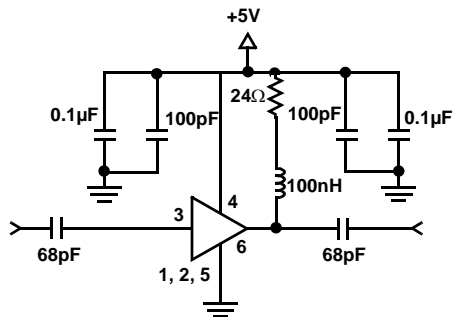

Pin Configuration

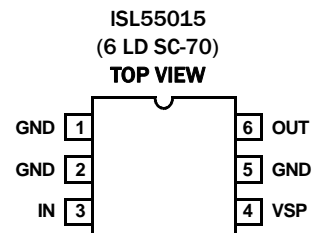

ISL55015

Absolute Maximum Ratings (T_A = +25°C)

Supply Voltage from VSP to GND	6V
Input Voltage	V _S + +0.3V to GND -0.3V
Ambient Operating Temperature	-40°C to +85°C
Storage Temperature	-65°C to +125°C
Operating Junction Temperature	+135°C
ESD Rating	
Human Body Model (Per MIL-STD-883 Method 3015.7)	6000V
Machine Model (Per EIAJ ED-4701 Method C-111)	250V

Thermal Information

Thermal Resistance (Typical)	θ _{JA} (°C/W)	θ _{JC} (°C/W)
6 Ld SC-70 (Notes 4, 5)	255	195
Pb-Free Reflow Profile	see link below http://www.intersil.com/pbfree/Pb-FreeReflow.asp	

CAUTION: Do not operate at or near the maximum ratings listed for extended periods of time. Exposure to such conditions may adversely impact product reliability and result in failures not covered by warranty.

NOTES:

- θ_{JA} is measured with the component mounted on a high effective thermal conductivity test board in free air. See Tech Brief [TB379](#) for details.
- For θ_{JC}, the “case temp” location is taken at the package top center.

Electrical Specifications V_{SP} = +5V, Z_{RSC} = Z_{LOAD} = 50Ω, T_A = +25°C, 24Ω V_{SP} to OUT, unless otherwise specified.

PARAMETER	DESCRIPTION	CONDITIONS	MIN (Note 6)	TYP	MAX (Note 6)	UNIT
Vsp	Supply Voltage	To operate below 5V, the 24Ω resistor to supply should be reduced	3.0		5.5	V
Gt	Small Signal Gain	1.0GHz	12.3	13.5	14.8	dB
		1.5GHz	11.7	13.3	14.2	dB
		2.0GHz	11	12.4	13.5	dB
P1dB	Output Power at 1dB Compression	1.0GHz	16.4	18.1	21.6	dBm
		2.0GHz	15.3	19.4	21.0	dBm
OIP3	Output Third Order Intercept Point	1.0GHz		31.3		dBm
		2.0GHz		28.4		dBm
OIP2	Output Second Order Intercept Point	Input tones at 1.0GHz and 1.1GHz, at Input Power = -15dBm, Output tone 2.1GHz		47		dBm
BW	3dB Bandwidth	3dB below Gain @ 500MHz		2.9		GHz
IRL	Input Return Loss	1.0GHz Z _{RSC} = 75Ω, Z _{LOAD} = 50Ω		20.2		dB
ORL	Output Return Loss	1.0GHz Z _{RSC} = 75Ω, Z _{LOAD} = 50Ω		21.4		dB
RISOL	Reverse Isolation	2.0GHz		18.9		dB
NF	Noise Figure	2.0GHz		4.8		dB
ID	Device Operating Current		54	62.5	69	mA

NOTE:

- Parameters with MIN and/or MAX limits are 100% tested at +25°C, unless otherwise specified. Temperature limits established by characterization and are not production tested.

Device Test Setup

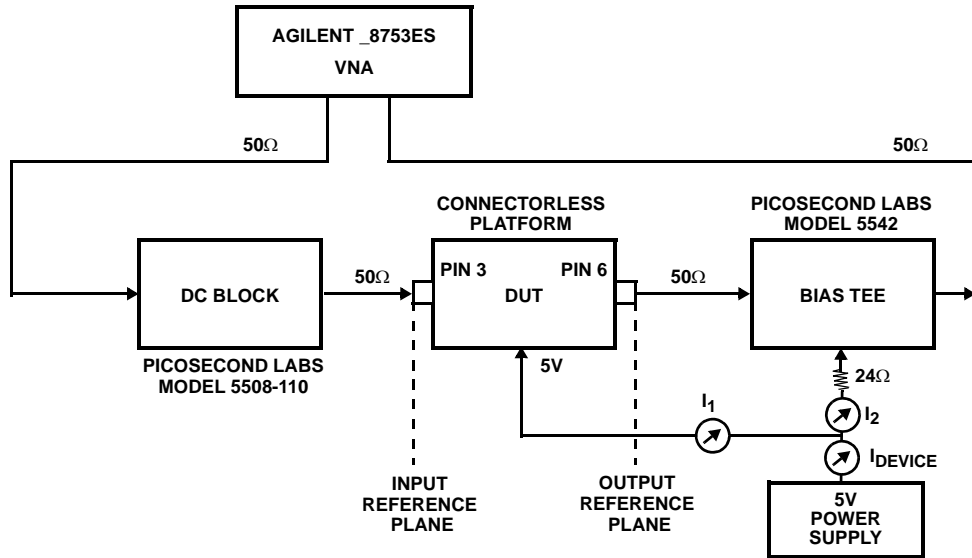

Typical Performance Curves $Z_{RSC} = 75\Omega, Z_{LOAD} = 50\Omega$

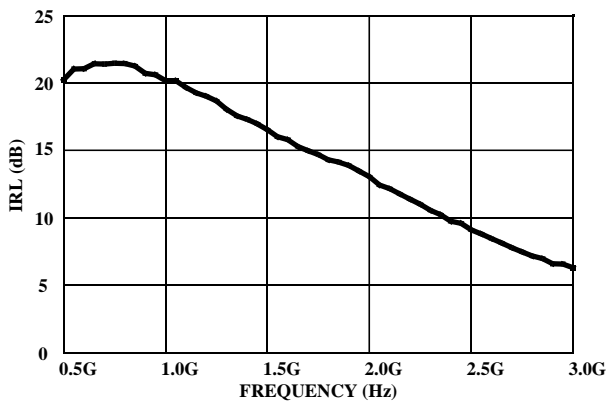

FIGURE 1. INPUT RETURN LOSS vs FREQUENCY

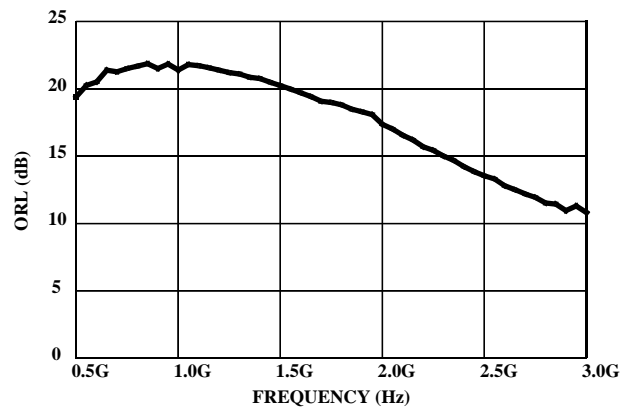

FIGURE 2. OUTPUT RETURN LOSS vs FREQUENCY

Typical Performance Curves 50Ω Environment

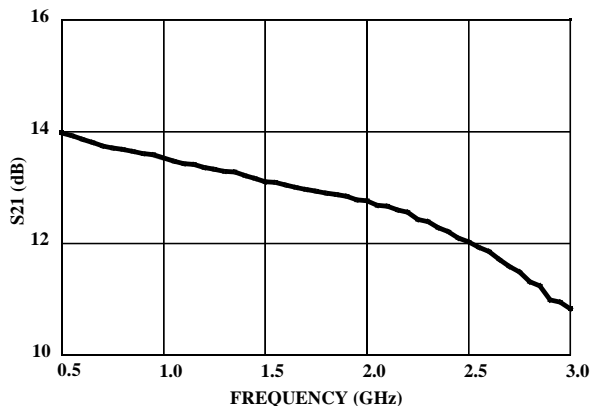

FIGURE 3. |S21| vs FREQUENCY

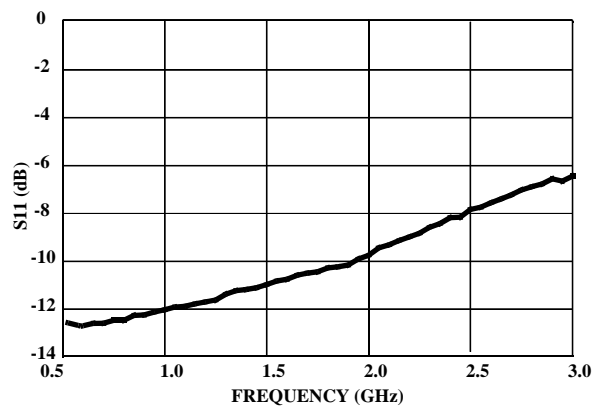

FIGURE 4. |S11| vs FREQUENCY

Typical Performance Curves 50Ω Environment (Continued)

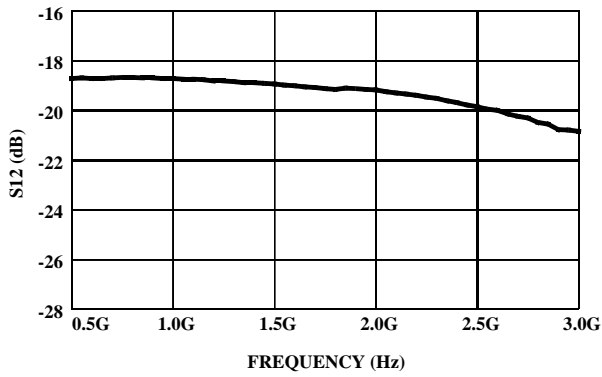

FIGURE 5. |S12| vs FREQUENCY

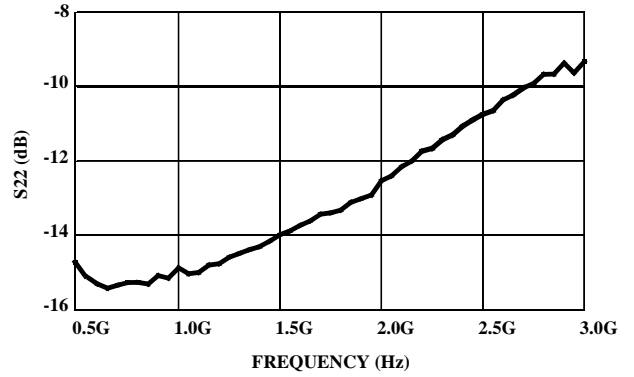

FIGURE 6. |S22| vs FREQUENCY

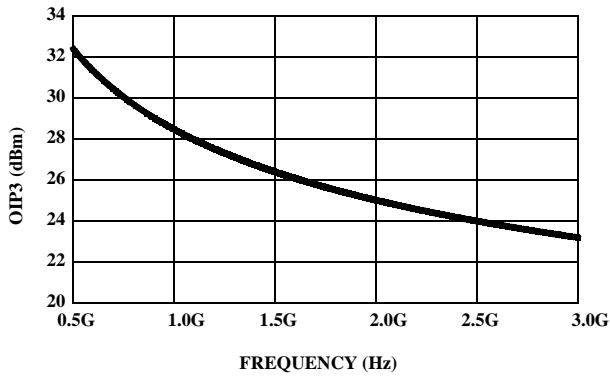

FIGURE 7. OIP3 vs FREQUENCY

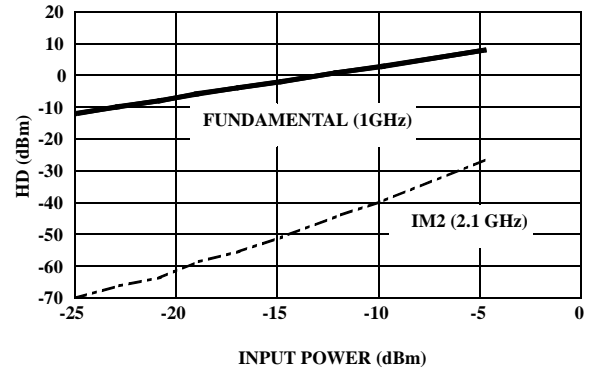

FIGURE 8. IM2 vs INPUT POWER

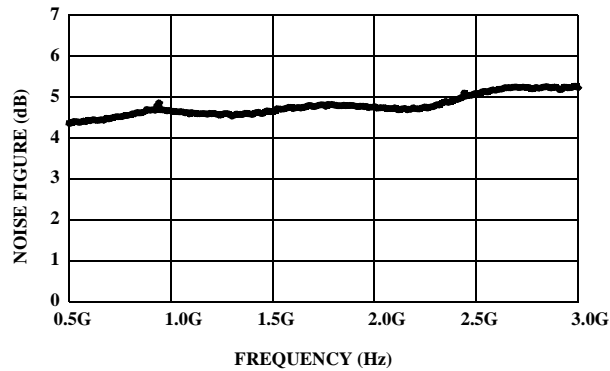

FIGURE 9. NOISE FIGURE vs FREQUENCY

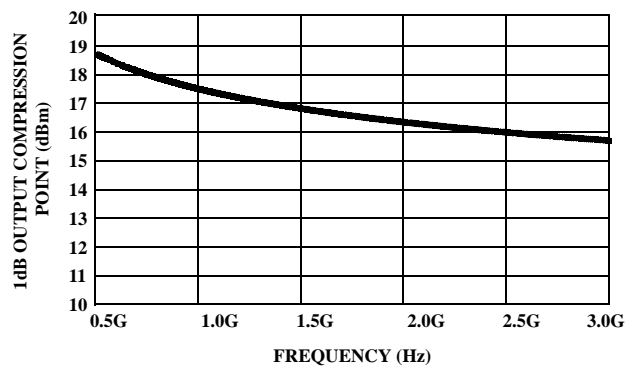

FIGURE 10. P1dB vs FREQUENCY

Typical Performance Curves 50Ω Environment (Continued)

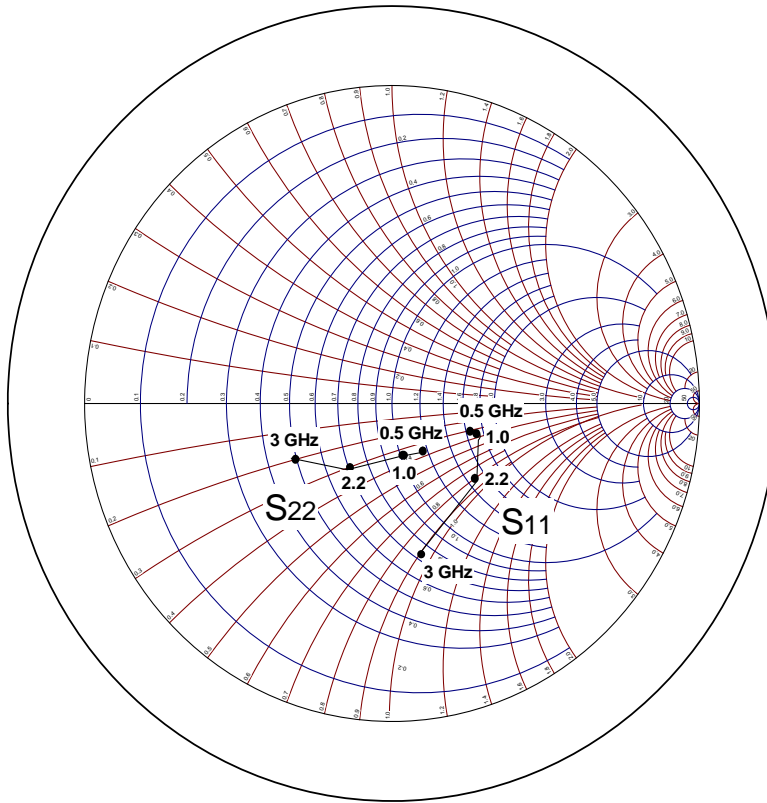
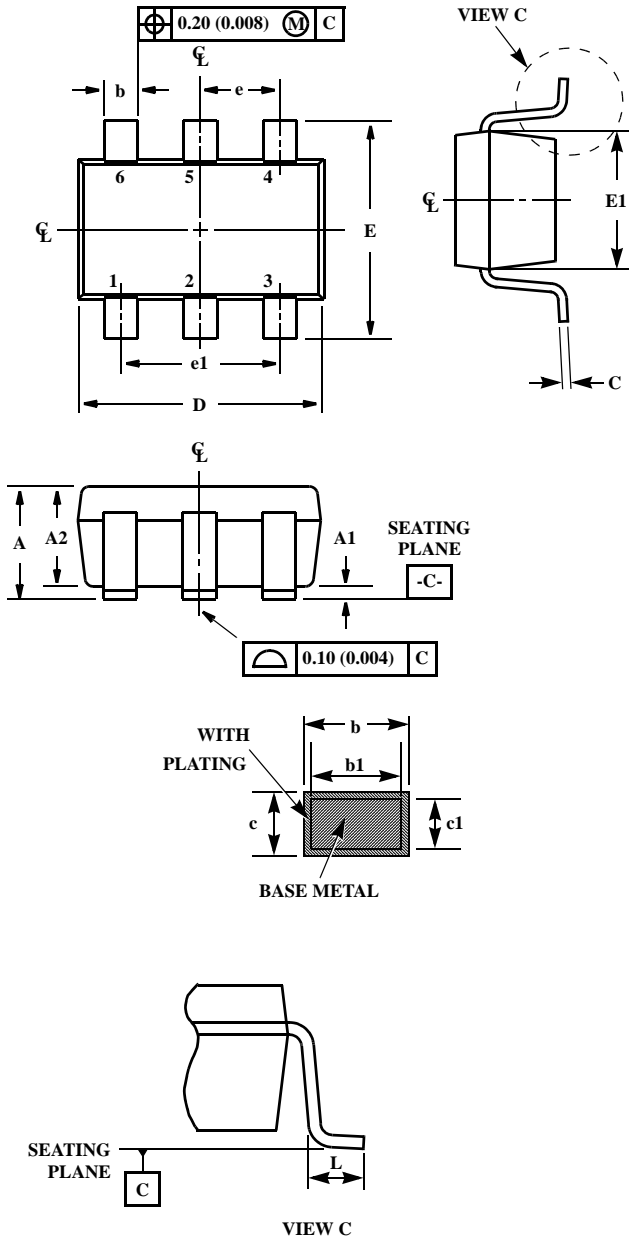

FIGURE 11. S11 AND S22 vs FREQUENCY

Small Outline Transistor Plastic Packages (SC70-6)



P6.049B

6 LEAD SMALL OUTLINE TRANSISTOR PLASTIC PACKAGE

SYMBOL	MILLIMETERS		NOTES
	MIN	MAX	
A	0.80	1.00	-
A1	0.000	0.09	-
A2	0.80	0.91	-
b	0.15	0.30	-
b1	0.15	0.25	-
c	0.08	0.25	6
e1	0.10	0.15	6
D	1.85	2.25	3
E	2.30 BSC		-
E1	1.15	1.35	3
e	0.65 Ref		-
e1	1.30 Ref		-
L	0.21	0.44	4
N	6		5

Rev. 0 4/07

NOTES:

1. Dimensioning and tolerance per ASME Y14.5M-1994.
2. Package conforms to EIAJ SC70 and JEDEC MO203AB.
3. Dimensions D and E1 are exclusive of mold flash, protrusions, or gate burrs.
4. Footlength L measured at reference to gauge plane.
5. "N" is the number of terminal positions.
6. These Dimensions apply to the flat section of the lead between 0.08mm and 0.15mm from the lead tip.

For additional products, see www.intersil.com/product_tree

Intersil products are manufactured, assembled and tested utilizing ISO9000 quality systems as noted in the quality certifications found at www.intersil.com/design/quality

Intersil products are sold by description only. Intersil Corporation reserves the right to make changes in circuit design, software and/or specifications at any time without notice. Accordingly, the reader is cautioned to verify that data sheets are current before placing orders. Information furnished by Intersil is believed to be accurate and reliable. However, no responsibility is assumed by Intersil or its subsidiaries for its use; nor for any infringements of patents or other rights of third parties which may result from its use. No license is granted by implication or otherwise under any patent or patent rights of Intersil or its subsidiaries.

For information regarding Intersil Corporation and its products, see www.intersil.com

Mouser Electronics

Authorized Distributor

Click to View Pricing, Inventory, Delivery & Lifecycle Information:

[Intersil:](#)

[ISL55015IEZ-T7](#) [ISL55015IEZ-EVAL](#)