

# Single Micropower, Chopper Stabilized, RRIO Operational Amplifier

## ISL28133

The ISL28133 is a single micropower, chopper stabilized operational amplifier that is optimized for single supply operation from 1.8V to 5.5V. Its low supply current of 18 $\mu$ A and wide input range enable the ISL28133 to be an excellent general purpose op amp for a range of applications. The ISL28133 is ideal for handheld devices that operate off 2 AA or single Li-ion batteries.

The ISL28133 is available in the 5 Ld SOT-23, the 5 Ld SC70 and the 6 Ld 1.6mmx1.6mm  $\mu$ TDFN packages. All devices operate over the extended temperature range of -40 $^{\circ}$ C to +125 $^{\circ}$ C.

## Related Literature

- [AN1480](#) "ISL28133ISENSEV1Z Evaluation Board User's Guide"
- [AN1499](#) "ISL28133EVAL1Z High-Gain Evaluation Board User's Guide"

## Features

- Low input offset voltage ..... 8 $\mu$ V, Max.
- Low offset TC ..... 0.075 $\mu$ V/ $^{\circ}$ C, Max
- Input bias current ..... 300pA, Max.
- Quiescent current ..... 18 $\mu$ A, Typ.
- Wide supply range ..... 1.8V to 5.5V
- Low noise (0.01Hz to 10Hz) ..... 1.1 $\mu$ V<sub>p-p</sub>, Typ.
- Rail-to-rail inputs and output
- Operating temperature range ..... -40 $^{\circ}$ C to +125 $^{\circ}$ C

## Applications

- Bidirectional current sense
- Temperature measurement
- Medical equipment
- Electronic weigh scales

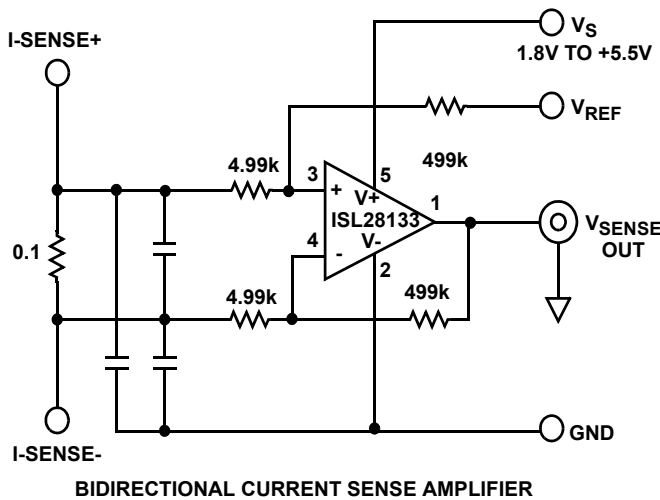

FIGURE 1. TYPICAL APPLICATION CIRCUIT

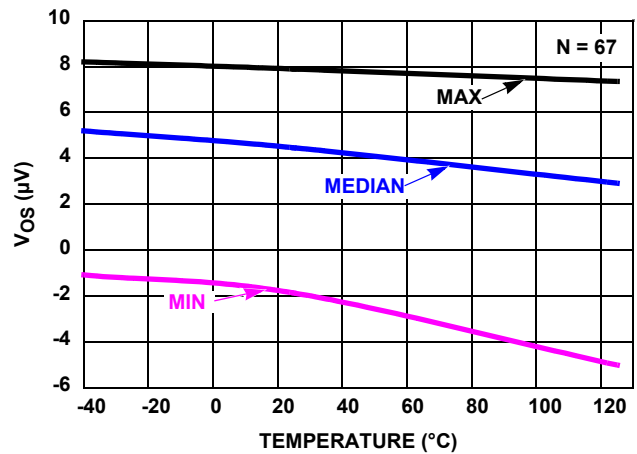
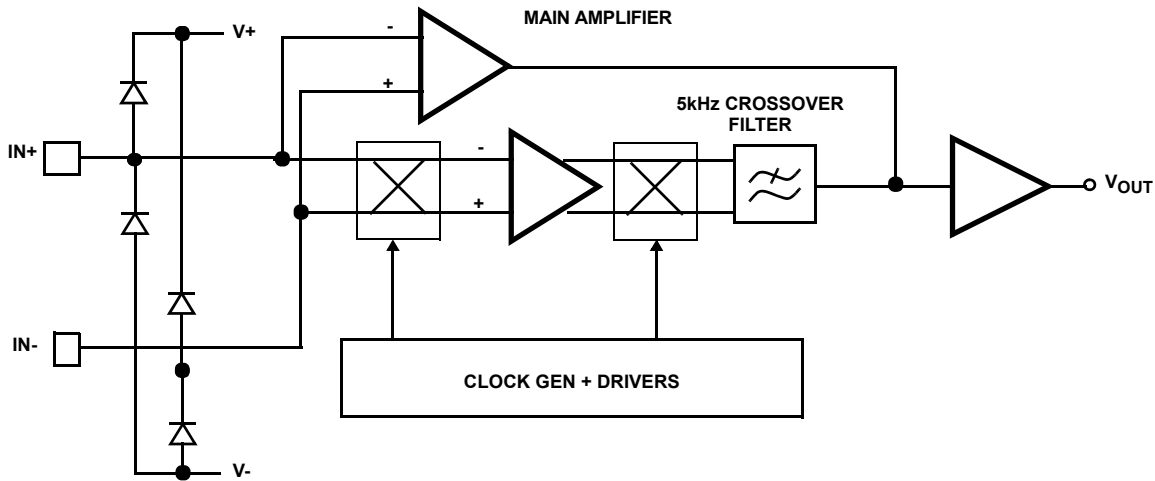

FIGURE 2. VOS vs TEMPERATURE

## Block Diagram



## Ordering Information

PART NUMBER	PART MARKING	PACKAGE Tape & Reel (Pb-Free)	PKG. DWG. #
ISL28133FHZ-T7 (Notes 1, 2)	BCFA (Note 5)	5 Ld SOT-23	P5.064A
ISL28133FHZ-T7A (Notes 1, 2)	BCFA (Note 5)	5 Ld SOT-23	P5.064A
ISL28133FEZ-T7 (Notes 1, 2)	BHA (Note 5)	5 Ld SC70	P5.049
ISL28133FRUZ-T7 (Notes 1, 3)	T8	6 Ld $\mu$ TDFN	L6.1.6x1.6
ISL28133ISENSEV1Z	Evaluation Board		
ISL28133EVAL1Z	Evaluation Board		
ISL28133CSENSEV1Z	Evaluation Board		

### NOTES:

1. Please refer to [TB347](#) for details on reel specifications.
2. These Intersil Pb-free plastic packaged products employ special Pb-free material sets, molding compounds/die attach materials, and 100% matte tin plate plus anneal (e3 termination finish, which is RoHS compliant and compatible with both SnPb and Pb-free soldering operations). Intersil Pb-free products are MSL classified at Pb-free peak reflow temperatures that meet or exceed the Pb-free requirements of IPC/JEDEC J STD-020.
3. These Intersil Pb-free plastic packaged products employ special Pb-free material sets; molding compounds/die attach materials and NiPdAu plate - e4 termination finish, which is RoHS compliant and compatible with both SnPb and Pb-free soldering operations. Intersil Pb-free products are MSL classified at Pb-free peak reflow temperatures that meet or exceed the Pb-free requirements of IPC/JEDEC J STD-020.
4. For Moisture Sensitivity Level (MSL), please see device information page for [ISL28133](#). For more information on MSL please see techbrief [TB363](#).
5. The part marking is located on the bottom of the part.

# ISL28133

## Pin Configurations

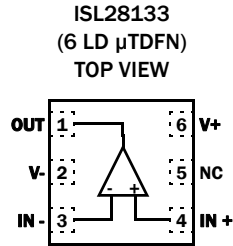
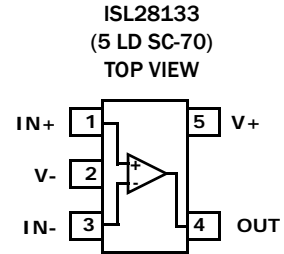
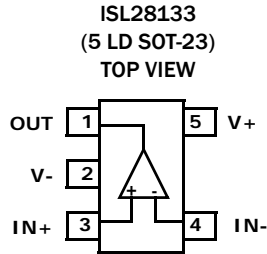

## Pin Descriptions

ISL28133 (5 Ld SOT23)	ISL28133 (5 Ld SC-70)	ISL28133 (6 Ld $\mu$ TDFN)	PIN NAME	FUNCTION	EQUIVALENT CIRCUIT
3	1	4	IN+	Non-inverting input	<p>Circuit 1</p>
2	2	2	V-	Negative supply	
4	3	3	IN-	Inverting input	(See Circuit 1)
1	4	1	OUT	Output	<p>Circuit 2</p>
5	5	6	V+	Positive supply	
		5	NC	Not Connected – This pin is not electrically connected internally.	

# ISL28133

## Absolute Maximum Ratings

Max Supply Voltage V+ to V-	6.5V
Max Voltage VIN to GND	-0.5V to 6.5V
Max Input Differential Voltage	6.5V
Max Input Current	20mA
Max Voltage VOUT to GND (10s)	6.5V
ESD Rating	
Human Body Model	3000V
Machine Model	200V
Charged Device Model	1500V

## Thermal Information

Thermal Resistance (Typical)	$\theta_{JA}$ (°C/W)	$\theta_{JC}$ (°C/W)
5 Ld SOT-23 (Note 6, 7)	225	110
5 Ld SC-70 (Note 6)	206	N/A
6 Ld $\mu$ TDFN (Note 6)	240	N/A
Maximum Storage Temperature Range	-65°C to +150°C	
Pb-Free Reflow Profile	see link below <a href="http://www.intersil.com/pbfree/Pb-FreeReflow.asp">http://www.intersil.com/pbfree/Pb-FreeReflow.asp</a>	

## Operating Conditions

Temperature Range	-40°C to +125°C
Maximum Junction Temperature	140°C

CAUTION: Do not operate at or near the maximum ratings listed for extended periods of time. Exposure to such conditions may adversely impact product reliability and result in failures not covered by warranty.

### NOTES:

- $\theta_{JA}$  is measured with the component mounted on a high effective thermal conductivity test board in free air. See Tech Brief [TB379](#) for details.
- For  $\theta_{JC}$ , the “case temp” location is taken at the package top center.

**Electrical Specifications**  $V_+ = 5V$ ,  $V_- = 0V$ ,  $V_{CM} = 2.5V$ ,  $T_A = +25^\circ C$ ,  $R_L = \text{Open}$ , unless otherwise specified. **Boldface limits apply over the operating temperature range, -40°C to +125°C.**

PARAMETER	DESCRIPTION	CONDITIONS	MIN (Note 8)	TYP	MAX (Note 8)	UNIT
<b>DC SPECIFICATIONS</b>						
V <sub>OS</sub>	Input Offset Voltage		-8	±2	8	μV
			<b>-15.5</b>		<b>15.5</b>	μV
TCV <sub>OS</sub>	Input Offset Voltage Temperature Coefficient			0.02	<b>0.075</b>	μV/°C
I <sub>OS</sub>	Input Offset Current			-60		pA
I <sub>B</sub>	Input Bias Current		-300	±30	300	pA
			<b>-600</b>		<b>600</b>	pA
Common Mode Input Voltage Range		V+ = 5.0V, V- = GND	-0.1		5.1	V
CMRR	Common Mode Rejection Ratio	VCM = -0.1V to 5.0V	118	125		dB
			<b>115</b>			dB
PSRR	Power Supply Rejection Ratio	Vs = 2V to 5.5V	110	138		dB
			<b>110</b>			dB
V <sub>OH</sub>	Output Voltage Swing, High	R <sub>L</sub> = 10kΩ	<b>4.965</b>	4.981		V
V <sub>OL</sub>	Output Voltage Swing, Low	R <sub>L</sub> = 10kΩ		18	<b>35</b>	mV
A <sub>OL</sub>	Open Loop Gain	R <sub>L</sub> = 1MΩ		174		dB
V+	Supply Voltage	(Note 9)	1.8		5.5	V
I <sub>S</sub>	Supply Current	R <sub>L</sub> = OPEN		18	25	μA
					<b>35</b>	μA
I <sub>SC+</sub>	Output Source Short Circuit Current	R <sub>L</sub> = Short to ground or V+	13	17	26	mA
I <sub>SC-</sub>	Output Sink Short Circuit Current		-26	-19	-13	mA
<b>AC SPECIFICATIONS</b>						
GBWP	Gain Bandwidth Product f = 50kHz	A <sub>V</sub> = 100, R <sub>F</sub> = 100kΩ, R <sub>G</sub> = 1kΩ, R <sub>L</sub> = 10kΩ to V <sub>CM</sub>		400		kHz

# ISL28133

**Electrical Specifications**  $V_+ = 5V$ ,  $V_- = 0V$ ,  $V_{CM} = 2.5V$ ,  $T_A = +25^\circ C$ ,  $R_L = \text{Open}$ , unless otherwise specified. **Boldface limits apply over the operating temperature range,  $-40^\circ C$  to  $+125^\circ C$ .** (Continued)

PARAMETER	DESCRIPTION	CONDITIONS	MIN (Note 8)	TYP	MAX (Note 8)	UNIT
$e_N V_{P-P}$	Peak-to-Peak Input Noise Voltage	$f = 0.01\text{Hz to }10\text{Hz}$		1.1		$\mu V_{P-P}$
$e_N$	Input Noise Voltage Density	$f = 1\text{kHz}$		65		$nV/\sqrt{\text{Hz}}$
$i_N$	Input Noise Current Density	$f = 1\text{kHz}$		72		$fA/\sqrt{\text{Hz}}$
		$f = 10\text{Hz}$		79		$fA/\sqrt{\text{Hz}}$
$C_{in}$	Differential Input Capacitance	$f = 1\text{MHz}$		1.6		pF
	Common Mode Input Capacitance			1.12		pF
<b>TRANSIENT RESPONSE</b>						
SR	Positive Slew Rate	$V_{OUT} = 1V \text{ to } 4V$ , $R_L = 10k\Omega$		0.2		$V/\mu s$
	Negative Slew Rate			0.1		$V/\mu s$
$t_r, t_f$ , Small Signal	Rise Time, $t_r$ 10% to 90%	$A_V = +1$ , $V_{OUT} = 0.1V_{P-P}$ , $R_F = 0\Omega$ , $R_L = 10k\Omega$ , $C_L = 1.2pF$		1.1		$\mu s$
	Fall Time, $t_f$ 10% to 90%			1.1		$\mu s$
$t_r, t_f$ Large Signal	Rise Time, $t_r$ 10% to 90%	$A_V = +1$ , $V_{OUT} = 2V_{P-P}$ , $R_F = 0\Omega$ , $R_L = 10k\Omega$ , $C_L = 1.2pF$		8		$\mu s$
	Fall Time, $t_f$ 10% to 90%			10		$\mu s$
$t_s$	Settling Time to 0.1%, $2V_{P-P}$ Step	$A_V = +1$ , $R_F = 0\Omega$ , $R_L = 10k\Omega$ , $C_L = 1.2pF$		35		$\mu s$

**NOTES:**

- 8. Compliance to datasheet limits is assured by one or more methods: production test, characterization and/or design.
- 9. Parts are 100% tested with a minimum operating voltage of 1.8V to a VOS limit of  $\pm 15\mu V$ .

## Typical Performance Curves $V_+ = 5V$ , $V_- = 0V$ , $V_{CM} = 2.5V$ , $R_L = \text{Open}$ .

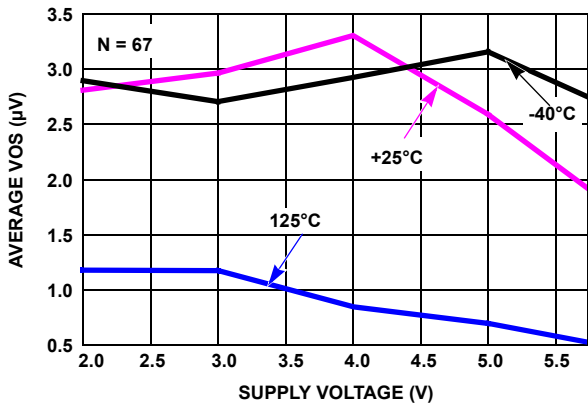

FIGURE 3. AVERAGE INPUT OFFSET VOLTAGE vs SUPPLY VOLTAGE

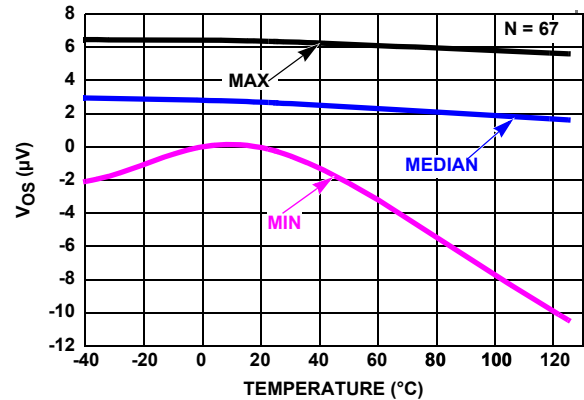

FIGURE 4.  $V_{OS}$  vs TEMPERATURE,  $V_S = \pm 1.0V$ ,  $V_{IN} = 0V$ ,  $R_L = \text{INF}$

**Typical Performance Curves**  $V_+ = 5V, V_- = 0V, V_{CM} = 2.5V, R_L = \text{Open. (Continued)}$

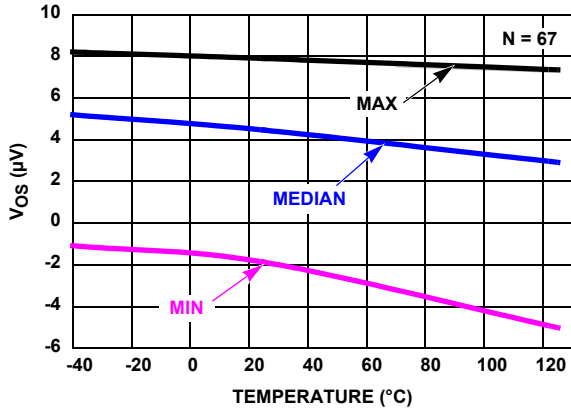

FIGURE 5.  $V_{OS}$  vs TEMPERATURE,  $V_S = \pm 2.5V, V_{IN} = 0V, R_L = \text{INF}$

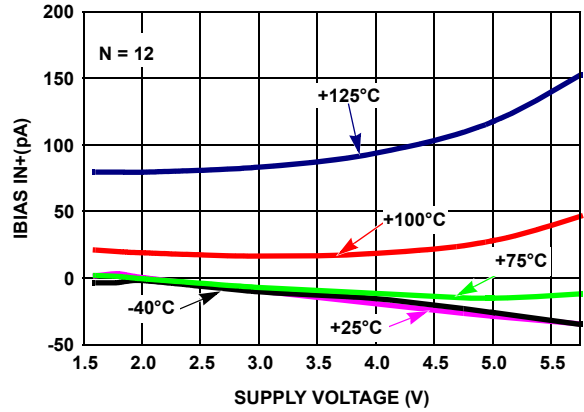

FIGURE 6.  $I_{B+}$  vs SUPPLY VOLTAGE vs TEMPERATURE

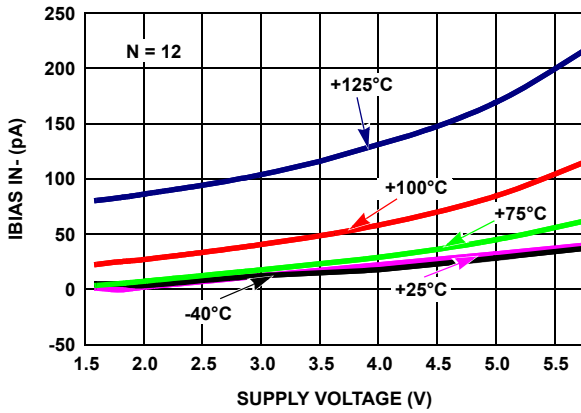

FIGURE 7.  $I_{B-}$  vs SUPPLY VOLTAGE vs TEMPERATURE

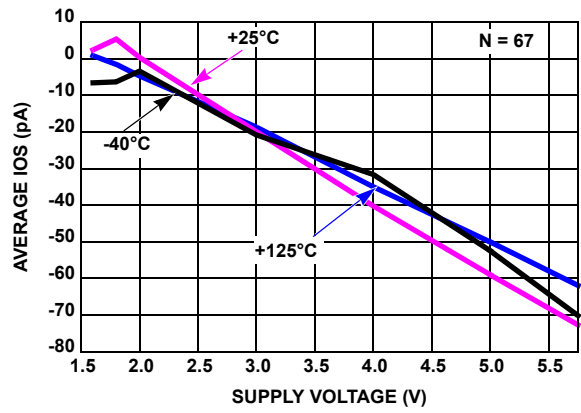

FIGURE 8.  $I_{OS}$  vs SUPPLY VOLTAGE vs TEMPERATURE

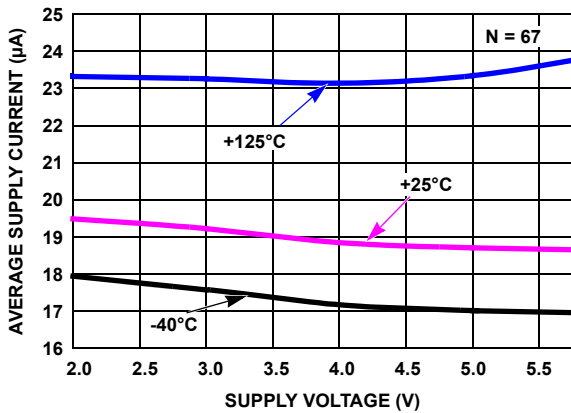

FIGURE 9. AVERAGE SUPPLY CURRENT vs SUPPLY VOLTAGE

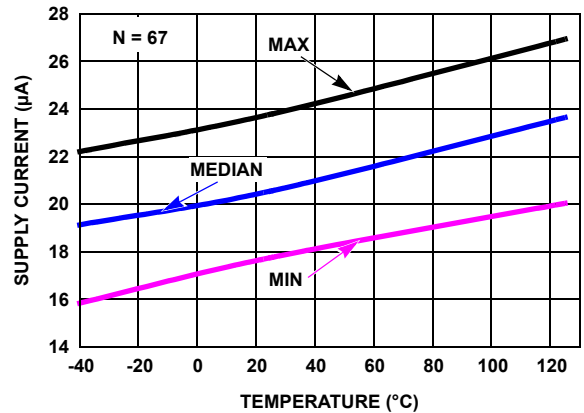

FIGURE 10. MIN/MAX SUPPLY CURRENT vs TEMPERATURE,  $V_S = \pm 0.8V, V_{IN} = 0V, R_L = \text{INF}$

**Typical Performance Curves**  $V_+ = 5V, V_- = 0V, V_{CM} = 2.5V, R_L = \text{Open}$ . (Continued)

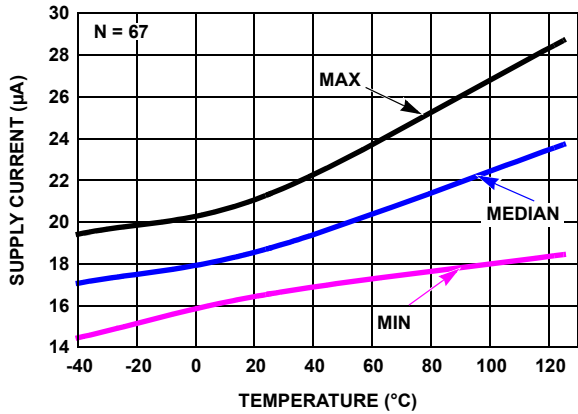

FIGURE 11. MIN/MAX SUPPLY CURRENT vs TEMPERATURE,  $V_S = \pm 2.5V, V_{IN} = 0V, R_L = \text{INF}$

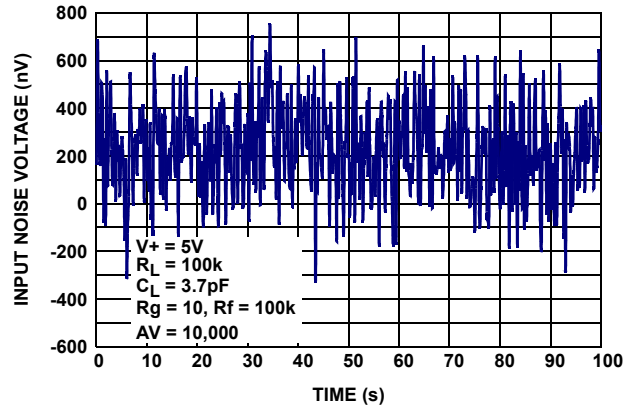

FIGURE 12. INPUT NOISE VOLTAGE 0.01Hz TO 10Hz

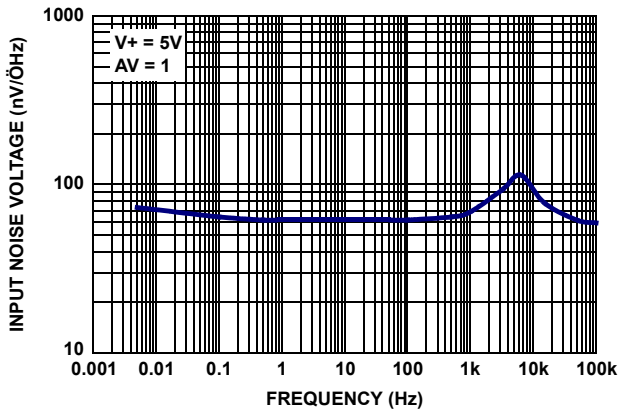

FIGURE 13. INPUT NOISE VOLTAGE DENSITY vs FREQUENCY

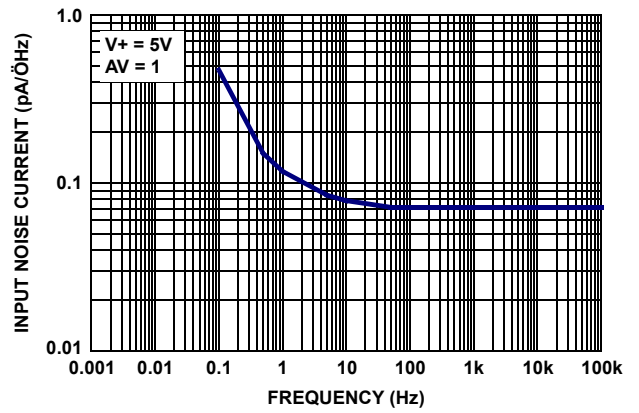

FIGURE 14. INPUT NOISE CURRENT DENSITY vs FREQUENCY

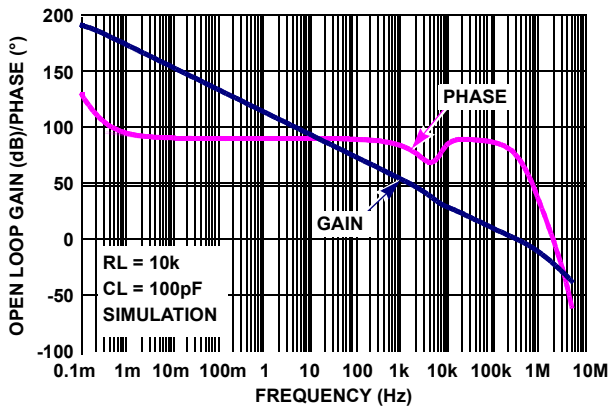

FIGURE 15. FREQUENCY RESPONSE vs OPEN LOOP GAIN,  $R_L = 10k$

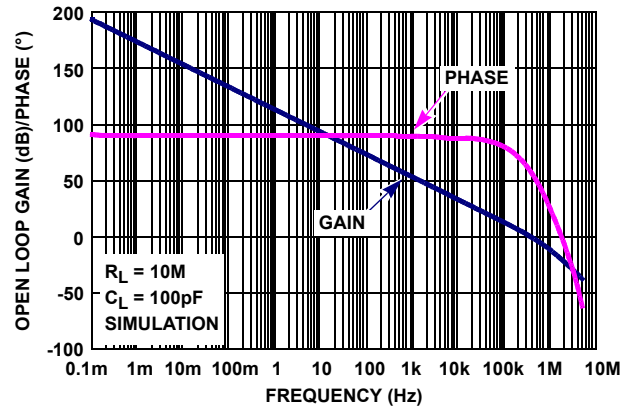

FIGURE 16. FREQUENCY RESPONSE vs OPEN LOOP GAIN,  $R_L = 10M$

Typical Performance Curves  $V_+ = 5V, V_- = 0V, V_{CM} = 2.5V, R_L = \text{Open}$ . (Continued)

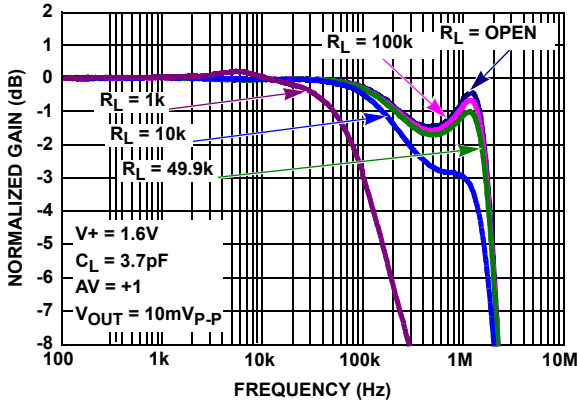

FIGURE 17. GAIN vs FREQUENCY vs  $R_L, V_S = 1.6V$

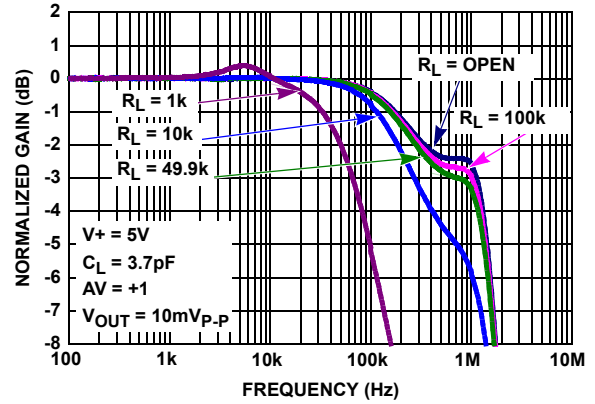

FIGURE 18. GAIN vs FREQUENCY vs  $R_L, V_S = 5V$

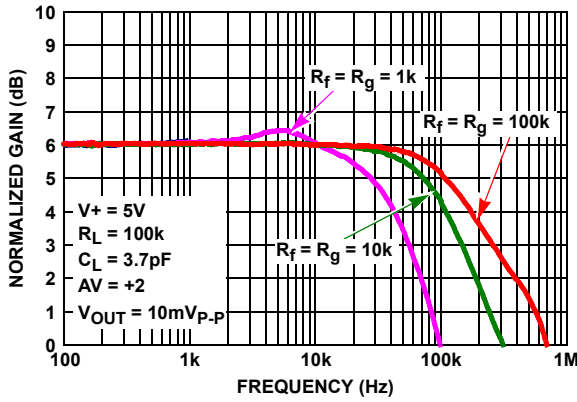

FIGURE 19. GAIN vs FREQUENCY vs FEEDBACK RESISTOR VALUES  $R_f/R_g$

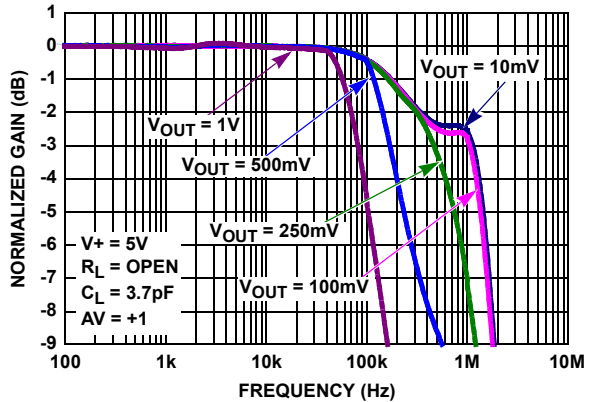

FIGURE 20. GAIN vs FREQUENCY vs  $V_{OUT}, R_L = \text{OPEN}$

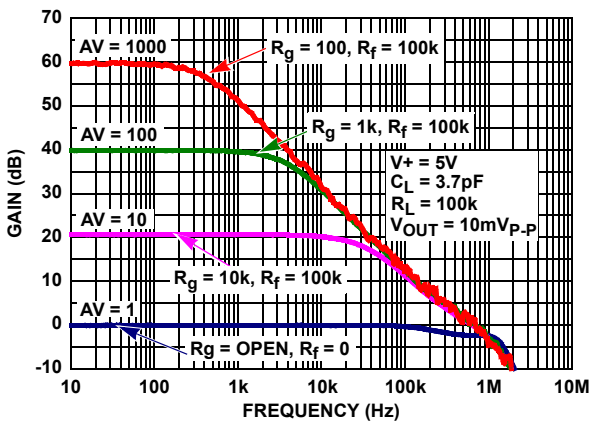

FIGURE 21. FREQUENCY RESPONSE vs CLOSED LOOP GAIN

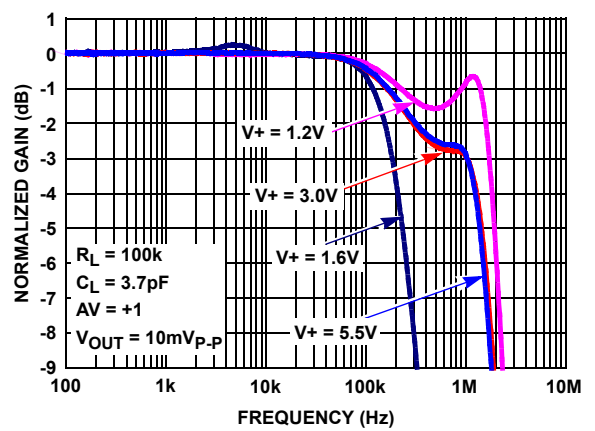

FIGURE 22. GAIN vs FREQUENCY vs SUPPLY VOLTAGE



Typical Performance Curves  $V_+ = 5V, V_- = 0V, V_{CM} = 2.5V, R_L = \text{Open. (Continued)}$

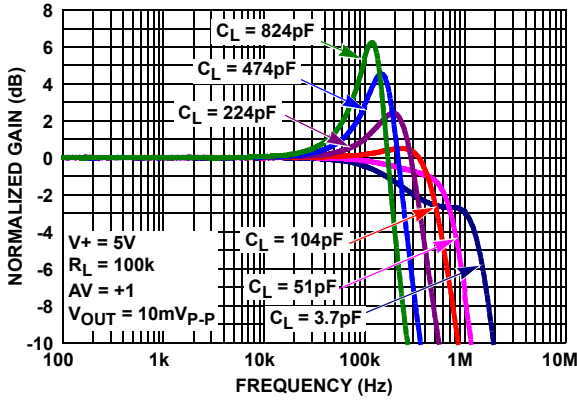

FIGURE 23. GAIN vs FREQUENCY vs  $C_L$

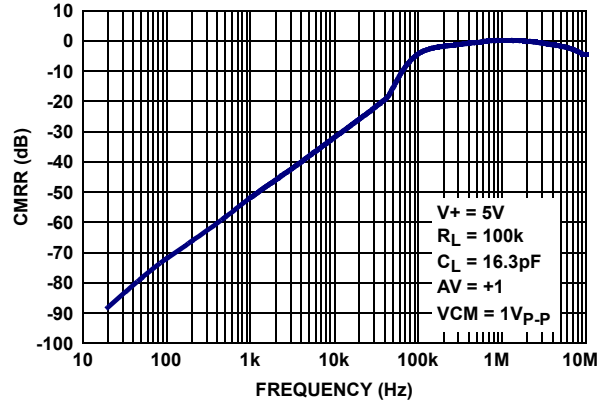

FIGURE 24. CMRR vs FREQUENCY,  $V_S = 5V$

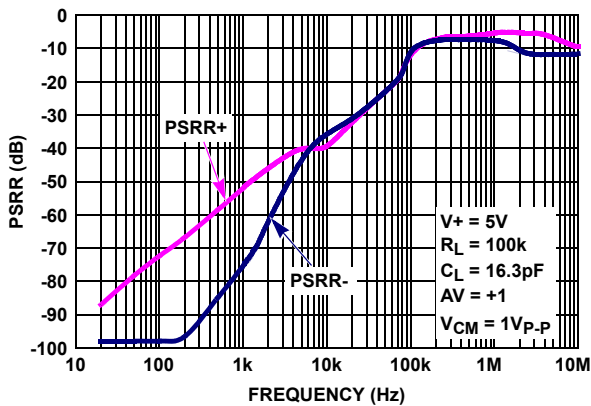

FIGURE 25. PSRR vs FREQUENCY,  $V_S = 5V$

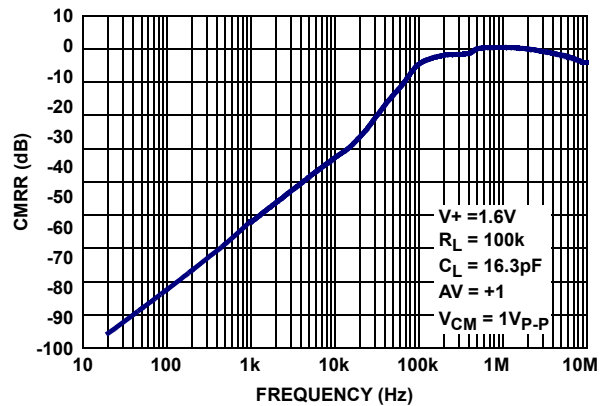

FIGURE 26. CMRR vs FREQUENCY,  $V_S = 1.6V$

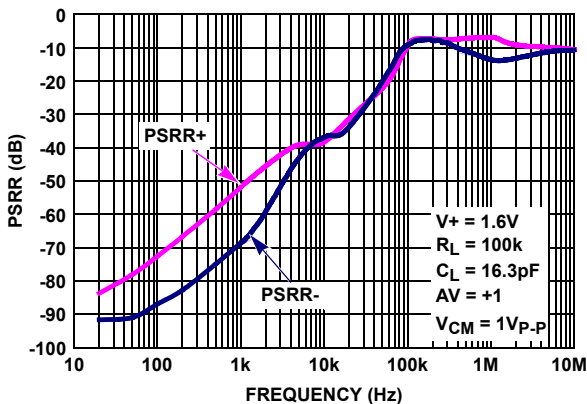

FIGURE 27. PSRR vs FREQUENCY,  $V_S = 1.6V$

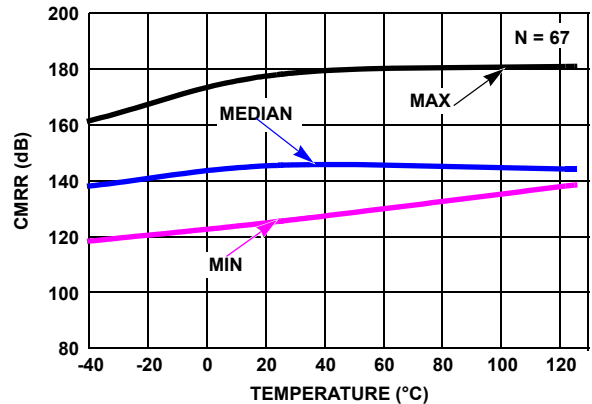

FIGURE 28. CMRR vs TEMPERATURE,  $V_{CM} = -2.5V \text{ TO } +2.5V, V_+ = \pm 2.5V$

Typical Performance Curves  $V_+ = 5V, V_- = 0V, V_{CM} = 2.5V, R_L = \text{Open}$ . (Continued)

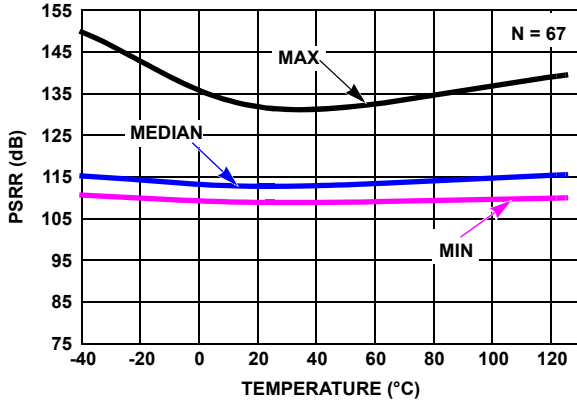

FIGURE 29. PSRR vs TEMPERATURE,  $V_+ = 2V$  TO  $5.5V$

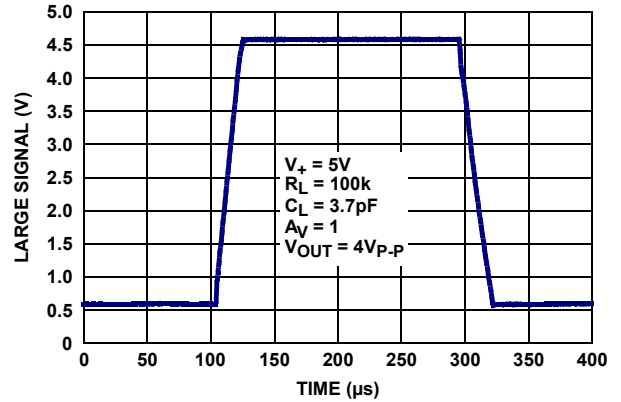

FIGURE 30. LARGE SIGNAL STEP RESPONSE (4V)

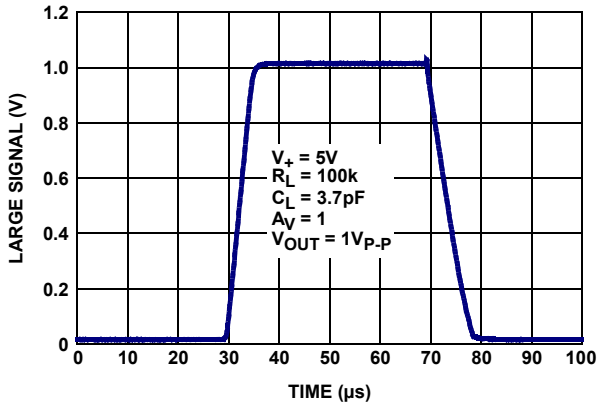

FIGURE 31. LARGE SIGNAL STEP RESPONSE (1V)

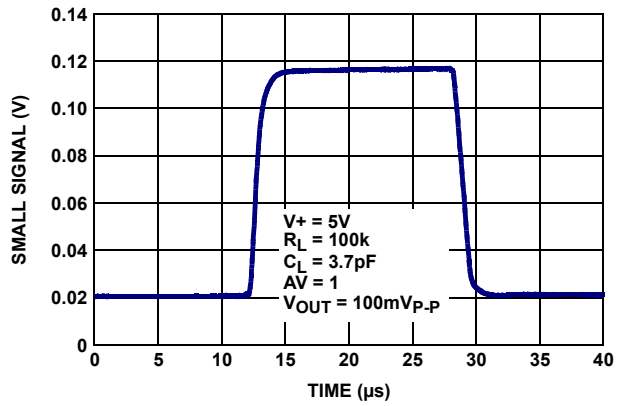

FIGURE 32. SMALL SIGNAL STEP RESPONSE (100mV)

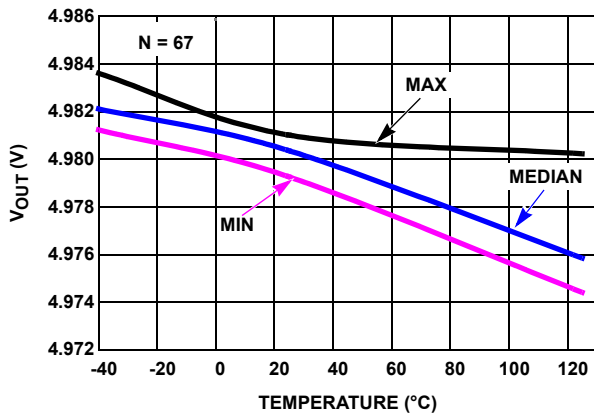

FIGURE 33.  $V_{OUT}$  HIGH vs TEMPERATURE,  $R_L = 10k, V_S +2.5V$

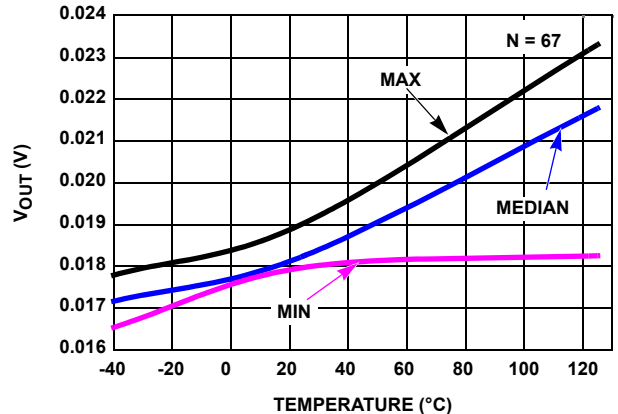

FIGURE 34.  $V_{OUT}$  LOW vs TEMPERATURE,  $R_L = 10k, V_S +2.5V$

## Applications Information

### Functional Description

The ISL28133 uses a proprietary chopper-stabilized architecture shown in the “Block Diagram” on page 2. The ISL28133 combines a 400kHz main amplifier with a very high open loop gain (174dB) chopper stabilized amplifier to achieve very low offset voltage and drift ( $2\mu\text{V}$ ,  $0.02\mu\text{V}/^\circ\text{C}$  typical) while consuming only  $18\mu\text{A}$  of supply current per channel.

This multi-path amplifier architecture contains a time continuous main amplifier whose input DC offset is corrected by a parallel-connected, high gain chopper stabilized DC correction amplifier operating at 100kHz. From DC to  $\sim 5\text{kHz}$ , both amplifiers are active with DC offset correction and most of the low frequency gain is provided by the chopper amplifier. A 5kHz crossover filter cuts off the low frequency amplifier path leaving the main amplifier active out to the 400kHz gain-bandwidth product of the device.

The key benefits of this architecture for precision applications are very high open loop gain, very low DC offset, and low  $1/f$  noise. The noise is virtually flat across the frequency range from a few mHz out to 100kHz, except for the narrow noise peak at the amplifier crossover frequency (5kHz).

### Rail-to-rail Input and Output (RRIO)

The RRIO CMOS amplifier uses parallel input PMOS and NMOS that enable the inputs to swing 100mV beyond either supply rail. The inverting and non-inverting inputs do not have back-to-back input clamp diodes and are capable of maintaining high input impedance at high differential input voltages. This is effective in eliminating output distortion caused by high slew-rate input signals.

The output stage uses common source connected PMOS and NMOS devices to achieve rail-to-rail output drive capability with 17mA current limit and the capability to swing to within 20mV of either rail while driving a  $10\text{k}\Omega$  load.

### IN+ and IN- Protection

All input terminals have internal ESD protection diodes to both positive and negative supply rails, limiting the input voltage to within one diode beyond the supply rails. For applications where either input is expected to exceed the rails by 0.5V, an external series resistor must be used to ensure the input currents never exceed 20mA (see Figure 35).

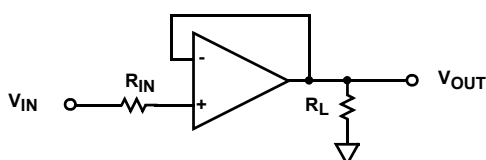

FIGURE 35. INPUT CURRENT LIMITING

### Layout Guidelines for High Impedance Inputs

To achieve the maximum performance of the high input impedance and low offset voltage of the ISL28133 amplifiers, care should be taken in the circuit board layout. The PC board surface must remain clean and free of moisture to avoid leakage currents between adjacent traces. Surface coating of the circuit board will reduce surface moisture and provide a humidity barrier, reducing parasitic resistance on the board.

### High Gain, Precision DC-Coupled Amplifier

The circuit in Figure 36 implements a single-stage,  $10\text{kV}/\text{V}$  DC-coupled amplifier with an input DC sensitivity of under  $100\text{nV}$  that is only possible using a low  $V_{OS}$  amplifier with high open loop gain. This circuit is practical down to  $1.8\text{V}$  due to its rail-to-rail input and output capability. Standard high gain DC amplifiers operating from low voltage supplies are not practical at these high gains using typical low offset precision op amps because the input offset voltage and temperature coefficient consume most of the available output voltage swing. For example, a typical precision amplifier in a gain of  $10\text{kV}/\text{V}$  with a  $\pm 100\mu\text{V}$   $V_{OS}$  and a temperature coefficient of  $0.5\mu\text{V}/^\circ\text{C}$  would produce a DC error at the output of  $>1\text{V}$  with an additional  $5\text{mV}/^\circ\text{C}$  of temperature dependent error. At 3V, this DC error consumes  $> 30\%$  of the total supply voltage, making it impractical to measure sub-microvolt low frequency signals.

The  $\pm 8\mu\text{V}$  max  $V_{OS}$  and  $0.075\mu\text{V}/^\circ\text{C}$  of the ISL28133 produces a temperature stable maximum DC output error of only  $\pm 80\text{mV}$  with a maximum temperature drift of  $0.75\text{mV}/^\circ\text{C}$ . The additional benefit of a very low  $1/f$  noise corner frequency and some feedback filtering enables DC voltages and voltage fluctuations well below  $100\text{nV}$  to be easily detected with a simple single stage amplifier.

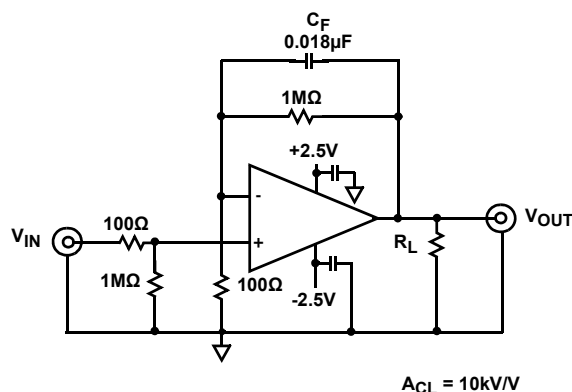

FIGURE 36. HIGH GAIN, PRECISION DC-COUPLED AMPLIFIER

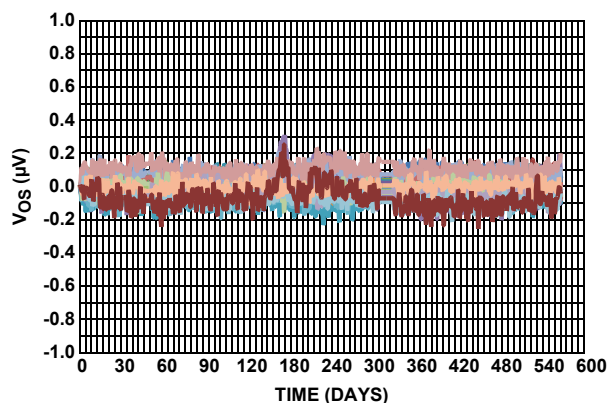

FIGURE 37. LONG TERM DRIFT ( $V_{OS}$  vs TIME) FOR 30 UNITS

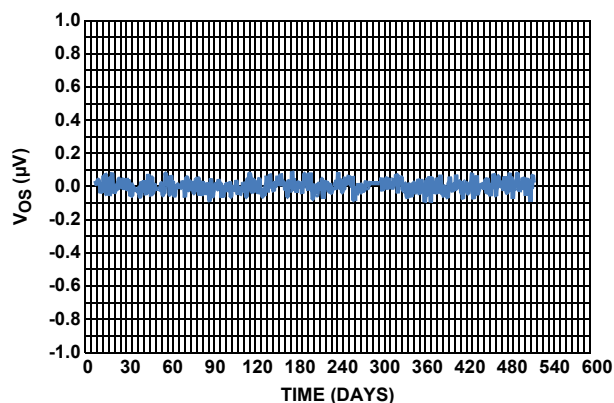

FIGURE 38. LONG TERM DRIFT ( $V_{OS}$  vs TIME) FOR A SINGLE UNIT

## Long Term $V_{OS}$ Drift

Figure 37 shows a plot of daily  $V_{OS}$  drift measurements of 30 individual ISL28133 amplifiers over a continuous 572 day period at +25°C. The 30 units were connected in a gain of 10k, mounted on a single PC board and kept at room temp. The 30 amplifier outputs were measured daily by a DVM and scanner under computer control. The daily  $V_{OS}$  measurements were subtracted from the initial  $V_{OS}$  value to calculate the  $V_{OS}$  shift. The test board was powered from a UPS to maintain uninterrupted power to the test units. Three instances of lost measurement data ranging from 2 days to 2 weeks due to power loss to the measurement scanner were detected, and data were interpolated.

The change in amplifier  $V_{OS}$  over the 572 day period for all 30 amplifiers (see Figure 38) was less than  $\pm 100\text{nV}$ , and no clear  $V_{OS}$  long term drift trend was evident in the data. The excellent long term drift performance is a result of the chopper amplifier's ability to measure and correct  $V_{OS}$  errors, leaving only the  $V_{OS}$  error contribution due to changes in the long term stability of the external components (see Figure 39).

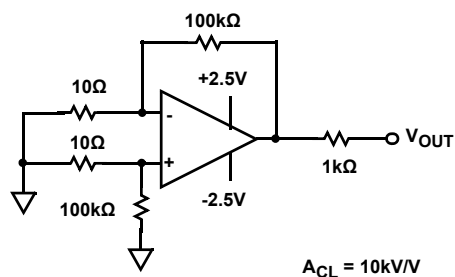

FIGURE 39. LONG TERM DRIFT TEST CIRCUIT

## ISL28133 SPICE Model

Figure 40 shows the SPICE model schematic and Figure 41 shows the net list for the ISL28133 SPICE model. The model is a simplified version of the actual device and simulates important parameters such as noise, Slew Rate, Gain and Phase. The model uses typical parameters from the ISL28133. The poles and zeros in the model were determined from the actual open and closed-loop gain and phase response. This enables the model to present an accurate AC representation of the actual device. The model is configured for ambient temperature of +25°C.

Figures 42 through 49 show the characterization vs simulation results for the Noise Density, Frequency Response vs Close Loop Gain, Gain vs Frequency vs CL and Large Signal Step Response (4V).

# ISL28133

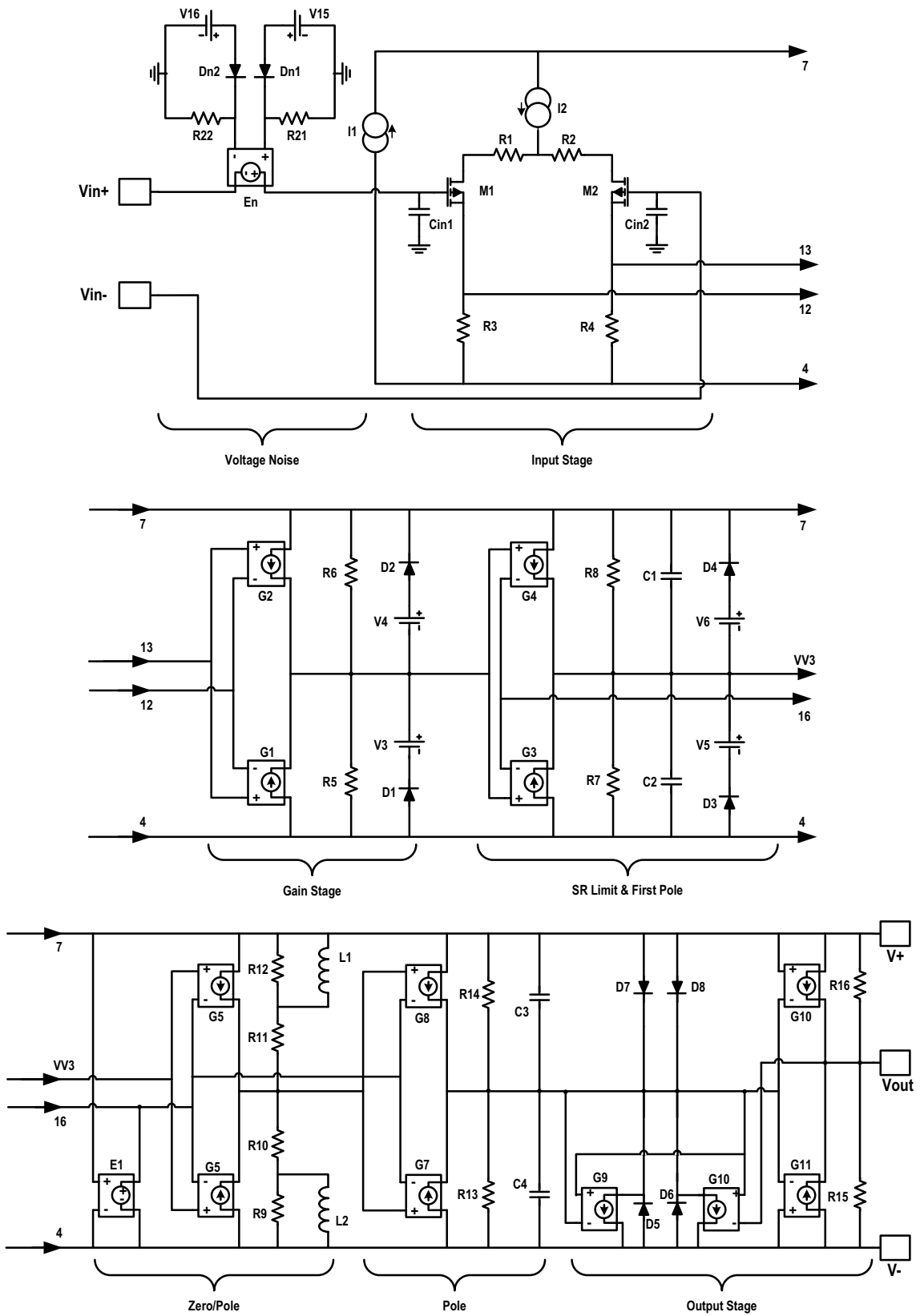

FIGURE 40. SPICE CIRCUIT SCHEMATIC

# ISL28133

```

* ISL28133 Macromodel
* Revision B, April 2009
* AC characteristics, Voltage Noise
* Connections:      +input
*                   |
*                   | -input
*                   | +Vsupply
*                   | -Vsupply
*                   |
*                   | output
*                   |
.subckt ISL28133    3    2    7    4    6
*
*Voltage Noise
D_DN1    102 101 DN
D_DN2    104 103 DN
R_R21    0 101 120k
R_R22    0 103 120k
E_EN     8 3 101 103 1
V_V15    102 0 0.1Vdc
V_V16    104 0 0.1Vdc
*
*Input Stage
C_Cin1    8 0 0.4p
C_Cin2    2 0 2.0p
R_R1     9 10 10
R_R2     10 11 10
R_R3     4 12 100
R_R4     4 13 100
M_M1     12 8 9 9 pmosisil
+ L=50u
+ W=50u
M_M2     13 2 11 11 pmosisil
+ L=50u
+ W=50u
I_I1     4 7 DC 92uA
I_I2     7 10 DC 100uA
*
*Gain stage
G_G1     4 VV2 13 12 0.0002
G_G2     7 VV2 13 12 0.0002
R_R5     4 VV2 1.3Meg
R_R6     VV2 7 1.3Meg
D_D1     4 14 DX
D_D2     15 7 DX
V_V3     VV2 14 0.7Vdc
V_V4     15 VV2 0.7Vdc
*
*SR limit first pole
G_G3     4 VV3 VV2 16 1
G_G4     7 VV3 VV2 16 1
R_R7     4 VV3 1meg
R_R8     VV3 7 1meg
C_C1     VV3 7 12u
C_C2     4 VV3 12u
D_D3     4 17 DX
D_D4     18 7 DX
V_V5     VV3 17 0.7Vdc

V_V6     18 VV3 0.7Vdc
*
*Zero/Pole
E_E1     16 4 7 4 0.5
G_G5     4 VV4 VV3 16 0.000001
G_G6     7 VV4 VV3 16 0.000001
L_L1     20 7 0.3H
R_R12    20 7 2.5meg
R_R11    VV4 20 1meg
L_L2     4 19 0.3H
R_R9     4 19 2.5meg
R_R10    19 VV4 1meg
*Pole
G_G7     4 VV5 VV4 16 0.000001
G_G8     7 VV5 VV4 16 0.000001
C_C3     VV5 7 0.12p
C_C4     4 VV5 0.12p
R_R13    4 VV5 1meg
R_R14    VV5 7 1meg
*
*Output Stage
G_G9     21 4 6 VV5 0.0000125
G_G10    22 4 VV5 6 0.0000125
D_D5     4 21 DY
D_D6     4 22 DY
D_D7     7 21 DX
D_D8     7 22 DX
R_R15    4 6 8k
R_R16    6 7 8k
G_G11    6 4 VV5 4 -0.000125
G_G12    7 6 7 VV5 -0.000125
*
.model pmosisil pmos (kp=16e-3 vto=10m)
.model DN D(KF=6.4E-16 AF=1)
.MODEL DX D(IS=1E-18 Rs=1)
.MODEL DY D(IS=1E-15 BV=50 Rs=1)
.ends ISL28133

```

FIGURE 41. SPICE NET LIST

# Characterization vs Simulation Results

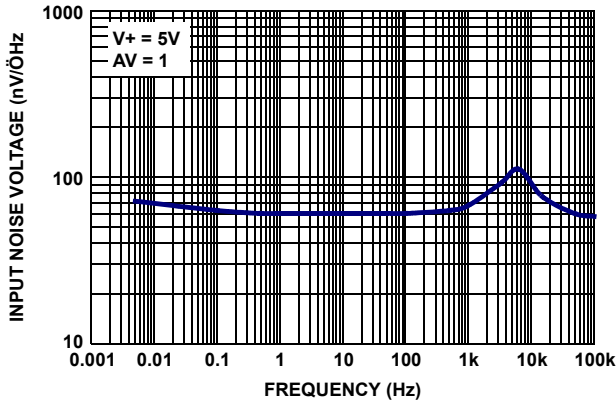

FIGURE 42. CHARACTERIZED INPUT NOISE VOLTAGE DENSITY vs FREQUENCY

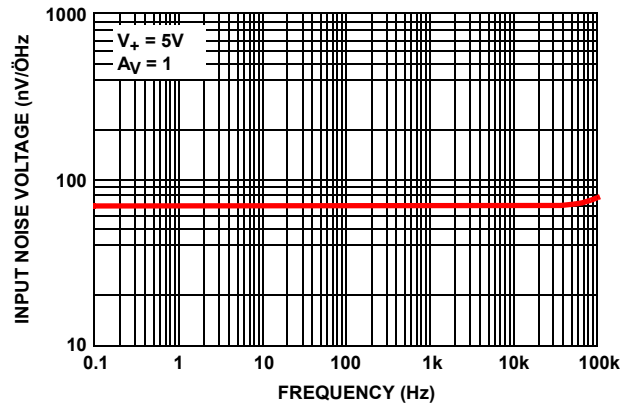

FIGURE 43. SIMULATED INPUT NOISE VOLTAGE DENSITY vs FREQUENCY

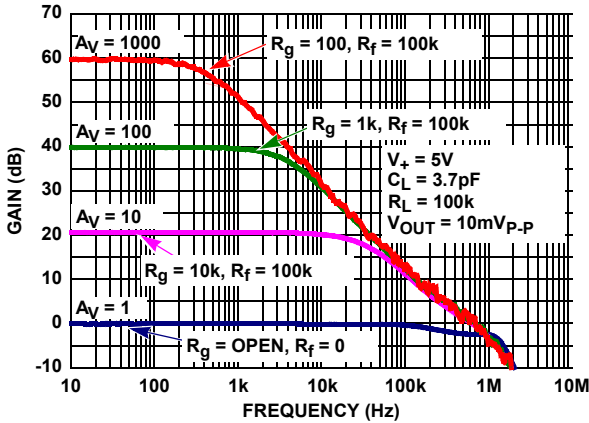

FIGURE 44. CHARACTERIZED FREQUENCY RESPONSE vs CLOSED LOOP GAIN

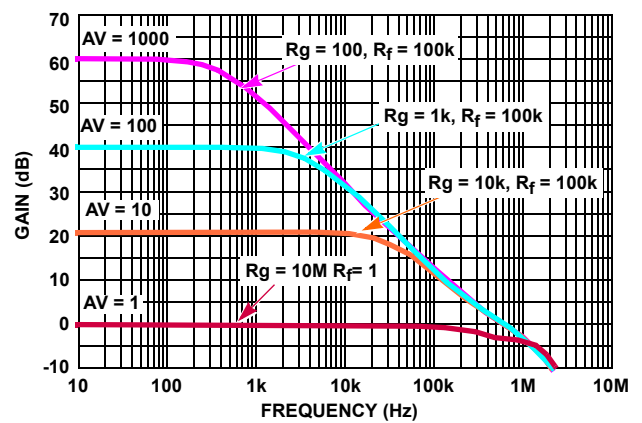

FIGURE 45. SIMULATED FREQUENCY RESPONSE vs CLOSED LOOP GAIN

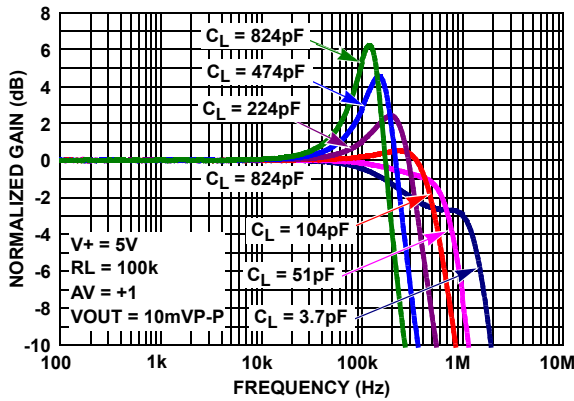

FIGURE 46. CHARACTERIZED GAIN vs FREQUENCY vs  $C_L$

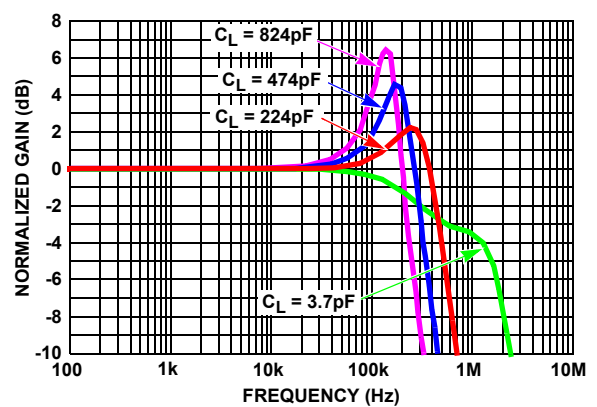

FIGURE 47. SIMULATED GAIN vs FREQUENCY vs  $C_L$

Characterization vs Simulation Results (Continued)

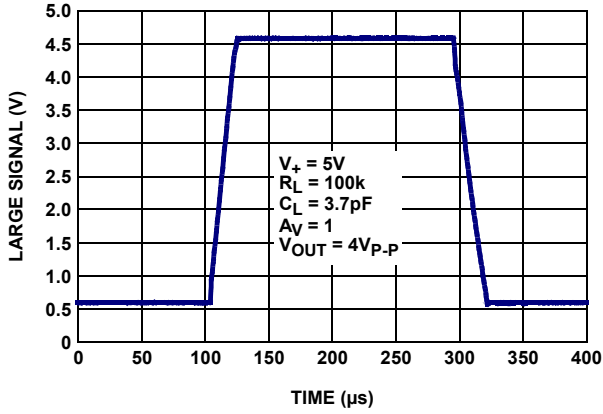

FIGURE 48. CHARACTERIZED LARGE SIGNAL STEP RESPONSE (4V)

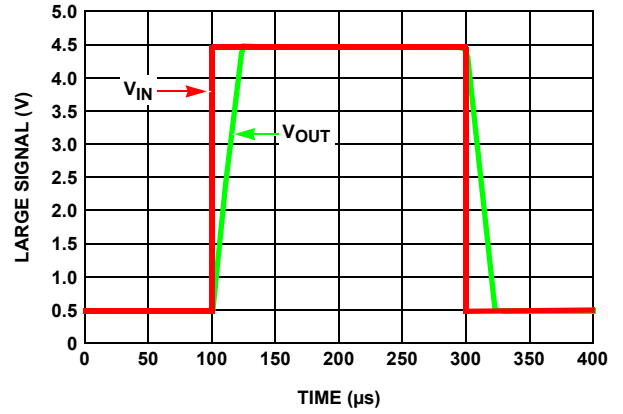

FIGURE 49. SIMULATED LARGE SIGNAL STEP RESPONSE (4V)



## Revision History

The revision history provided is for informational purposes only and is believed to be accurate, but not warranted. Please go to web to make sure you have the latest Rev.

DATE	REVISION	CHANGE
February 19, 2014	FN6560.6	Updated location of note references. Added ISL28133CSENSEV1Z to ordering information table on page 2.
May 31, 2011	FN6560.5	Changed minimum operating supply voltage from +1.65V to +1.8V throughout entire datasheet. Added Tjc information for 5 Ld SOT-23 package in Thermal information on page 5.
February 1, 2011	FN6560.4	-Converted to Updated Intersil Template. -Page 1 Graphics numbered as Figures 1 and 2. -Updated Ordering Information on page 2 by adding part ISL28133FHZ-T7A. -Changed Note on page 5, which read "Parameters with MIN and/or MAX limits are 100% tested at +25 °C, unless otherwise specified. Temperature limits established by characterization and are not production tested." to "Compliance to datasheet limits is assured by one or more methods: production test, characterization and/or design." -Added two Long Term Drift Curves (Figures 37 and 38) and section "Long Term VOS Drift" on page 12 -Replaced POD MDP0038 (no dimension changes), now obsolete with P5.064A.
May 3, 2010	FN6560.3	Title Page 1: Replaced "Zero-Drift" with "Chopper Stabilized" for title and part description On page 3: Pin Configuration: MTDFN -> uTDFN On page 7: Figure 12: Changed 0.1Hz to 0.01Hz in Figure caption On page 11: In "Functional Description"; Paragraph 1, 2nd sentence: Changed text from "...open loop gain (200dB)..." -to- "...open loop gain (174dB)..." Changed TYP for "Open Loop Gain" on page 4 from 200dB to 174dB. On page 11: In "High Gain, Precision DC-Coupled Amplifier"; Paragraph 2, 1st sentence: Changed text from "...DC output error of only ±80mV with a maximum temperature drift of 0.75µV/°C." to "... DC output error of only ±80mV with a maximum temperature drift of 0.75mV/C."
February 24, 2010		Removed "Coming Soon" from ISL28133EVAL1Z in the ordering information table on pg 2.
September 24, 2009	FN6560.2	Converted to new Intersil template. Removed ISL28233 and ISL28433 from data sheet, added Applications, Related Literature, Typical Application Circuit, Performance Curve, updated ordering information by removing "coming soon" on SC70 and uTDFN packages and adding Eval board listed as "coming soon". Added Block Diagram, Changed in Abs Max Rating Voltage from "5.75V" to "6.5V". Removed Tjc from Thermal Information until provided by packaging scheduled for 9-11-09. Changed Low Offset "drift" to Low Offset "TC", added Max Junction Temp 140C, added SPICE model and simulation results, removed supply current graph at +3V, re-ordered typical performance curves, removed guard ring information from application section. Added Revision History and Products Information
May 29, 2009	FN6560.1	Page 4: Removed the RL = 100 Curve from Figures 3, 4 and 5. Page 1: Under Features, removed the word "Output" from "Low Output Noise"
March 25, 2009	FN6560.0	Initial Release to WEB

## About Intersil

Intersil Corporation is a leader in the design and manufacture of high-performance analog, mixed-signal and power management semiconductors. The company's products address some of the largest markets within the industrial and infrastructure, personal computing and high-end consumer markets. For more information about Intersil, visit our website at [www.intersil.com](http://www.intersil.com).

For the most updated datasheet, application notes, related documentation and related parts, please see the respective product information page found at [www.intersil.com](http://www.intersil.com). You may report errors or suggestions for improving this datasheet by visiting [www.intersil.com/en/support/ask-an-expert.html](http://www.intersil.com/en/support/ask-an-expert.html). Reliability reports are also available from our website at <http://www.intersil.com/en/support/qualandreliability.html#reliability>

For additional products, see [www.intersil.com/en/products.html](http://www.intersil.com/en/products.html)

Intersil products are manufactured, assembled and tested utilizing ISO9001 quality systems as noted in the quality certifications found at [www.intersil.com/en/support/qualandreliability.html](http://www.intersil.com/en/support/qualandreliability.html)

*Intersil products are sold by description only. Intersil Corporation reserves the right to make changes in circuit design, software and/or specifications at any time without notice. Accordingly, the reader is cautioned to verify that data sheets are current before placing orders. Information furnished by Intersil is believed to be accurate and reliable. However, no responsibility is assumed by Intersil or its subsidiaries for its use; nor for any infringements of patents or other rights of third parties which may result from its use. No license is granted by implication or otherwise under any patent or patent rights of Intersil or its subsidiaries.*

For information regarding Intersil Corporation and its products, see [www.intersil.com](http://www.intersil.com)

## Small Outline Transistor Plastic Packages (SC70-5)

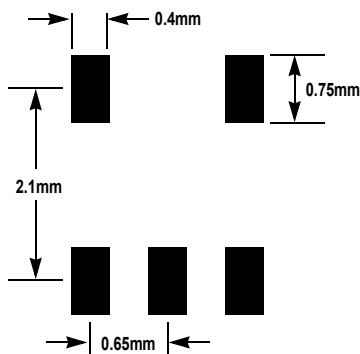
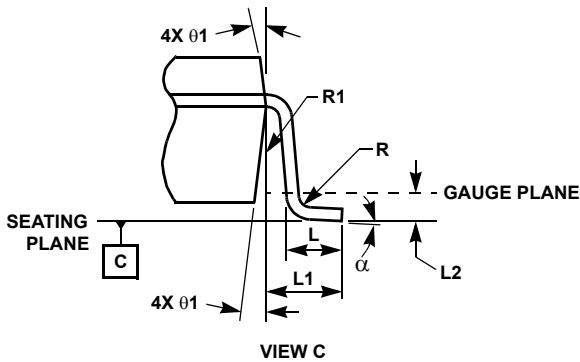
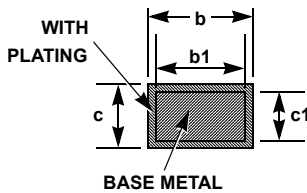
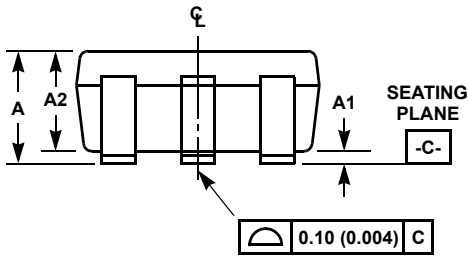
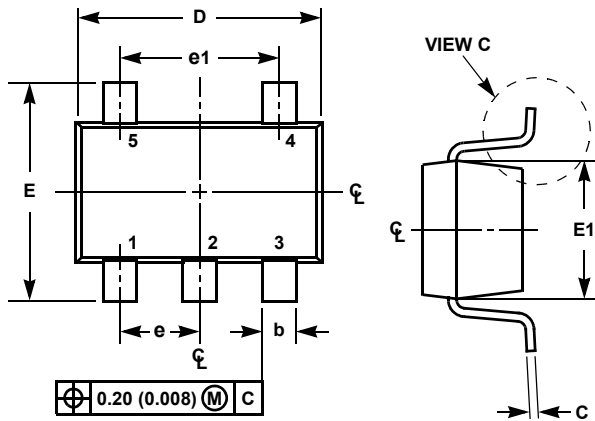

TYPICAL RECOMMENDED LAND PATTERN

### P5.049

#### 5 LEAD SMALL OUTLINE TRANSISTOR PLASTIC PACKAGE

SYMBOL	INCHES		MILLIMETERS		NOTES
	MIN	MAX	MIN	MAX	
A	0.031	0.043	0.80	1.10	-
A1	0.000	0.004	0.00	0.10	-
A2	0.031	0.039	0.80	1.00	-
b	0.006	0.012	0.15	0.30	-
b1	0.006	0.010	0.15	0.25	-
c	0.003	0.009	0.08	0.22	6
c1	0.003	0.009	0.08	0.20	6
D	0.073	0.085	1.85	2.15	3
E	0.071	0.094	1.80	2.40	-
E1	0.045	0.053	1.15	1.35	3
e	0.0256 Ref		0.65 Ref		-
e1	0.0512 Ref		1.30 Ref		-
L	0.010	0.018	0.26	0.46	4
L1	0.017 Ref.		0.420 Ref.		-
L2	0.006 BSC		0.15 BSC		-
α	0°	8°	0°	8°	-
N	5		5		5
R	0.004	-	0.10	-	-
R1	0.004	0.010	0.15	0.25	-

Rev. 3 7/07

#### NOTES:

1. Dimensioning and tolerances per ASME Y14.5M-1994.
2. Package conforms to EIAJ SC70 and JEDEC MO-203AA.
3. Dimensions D and E1 are exclusive of mold flash, protrusions, or gate burrs.
4. Footlength L measured at reference to gauge plane.
5. "N" is the number of terminal positions.
6. These Dimensions apply to the flat section of the lead between 0.08mm and 0.15mm from the lead tip.
7. Controlling dimension: MILLIMETER. Converted inch dimensions are for reference only.

## Package Outline Drawing

### L6.1.6x1.6

6 LEAD ULTRA THIN DUAL FLAT NO-LEAD COL PLASTIC PACKAGE (UTDFN COL)

Rev 1, 11/07

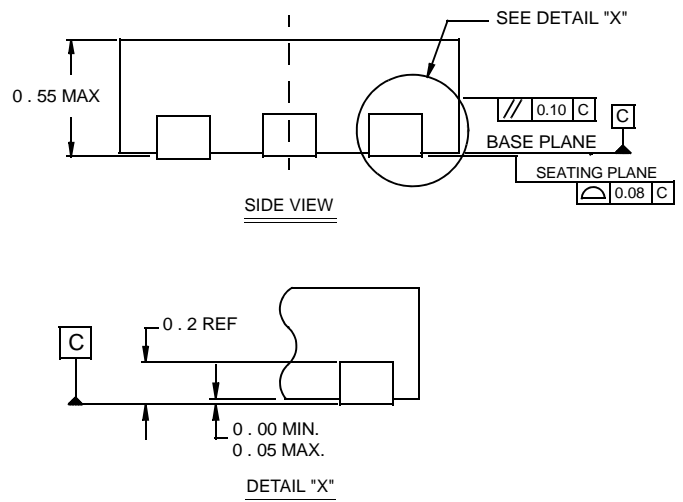
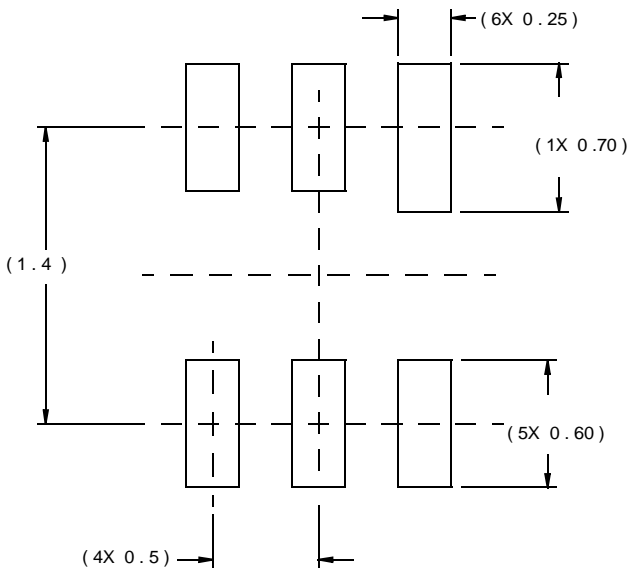
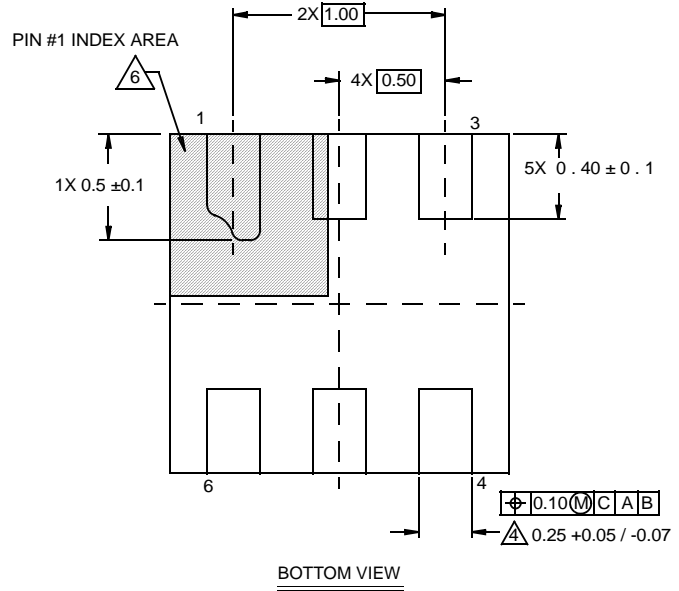
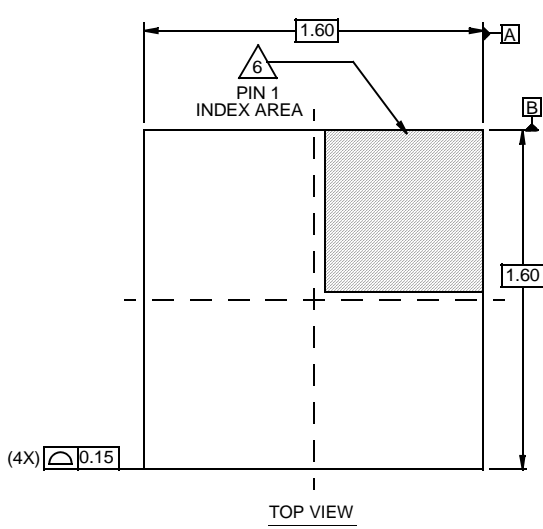

#### NOTES:

1. Dimensions are in millimeters.  
Dimensions in ( ) for Reference Only.
2. Dimensioning and tolerancing conform to AMSE Y14.5m-1994.
3. Unless otherwise specified, tolerance : Decimal  $\pm 0.05$
4. Dimension b applies to the metallized terminal and is measured between 0.15mm and 0.30mm from the terminal tip.
5. Tiebar shown (if present) is a non-functional feature.
6. The configuration of the pin #1 identifier is optional, but must be located within the zone indicated. The pin #1 identifier may be either a mold or mark feature.

Package Outline Drawing

P5.064A

5 LEAD SMALL OUTLINE TRANSISTOR PLASTIC PACKAGE

Rev 0, 2/10

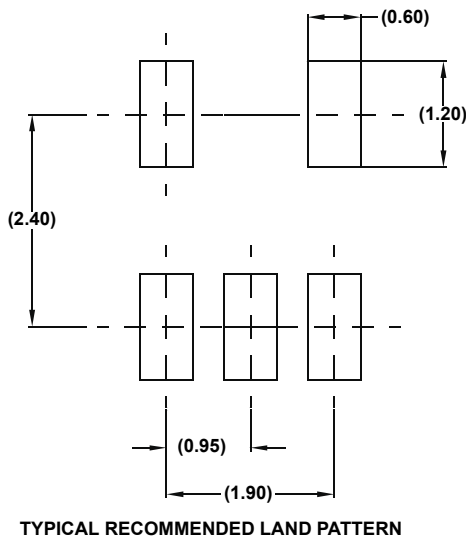
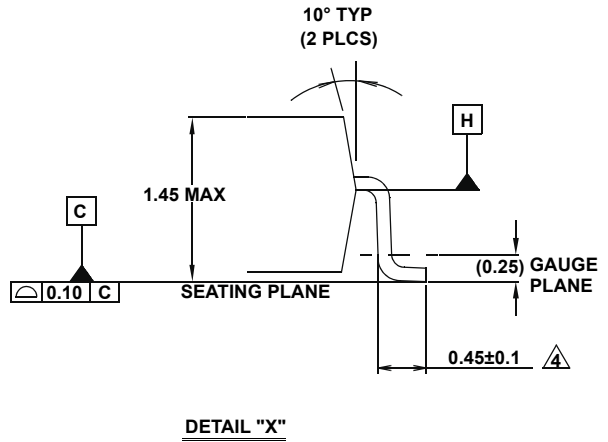
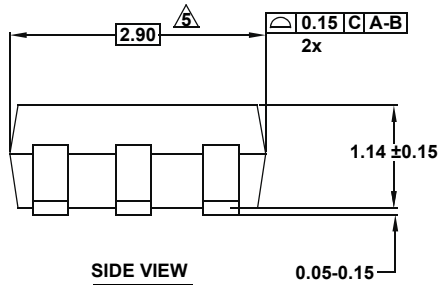
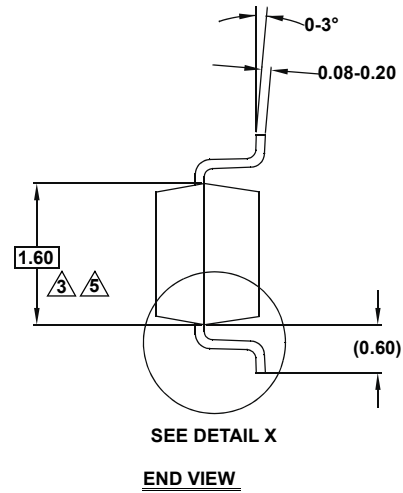
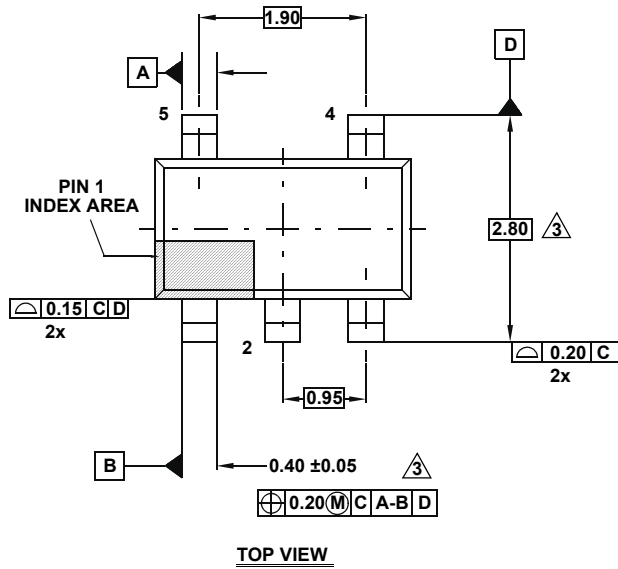

NOTES:

1. Dimensions are in millimeters.  
Dimensions in ( ) for Reference Only.
2. Dimensioning and tolerancing conform to ASME Y14.5M-1994.
3. Dimension is exclusive of mold flash, protrusions or gate burrs.
4. Foot length is measured at reference to gauge plane.
5. This dimension is measured at Datum "H".
6. Package conforms to JEDEC MO-178AA.

# Mouser Electronics

Authorized Distributor

Click to View Pricing, Inventory, Delivery & Lifecycle Information:

[Intersil:](#)

[ISL28133EVAL1Z](#) [ISL28133FHZ-T7](#) [ISL28133CSENSEV1Z](#)