

Analog Devices Welcomes Hittite Microwave Corporation

NO CONTENT ON THE ATTACHED DOCUMENT HAS CHANGED



THIS PAGE INTENTIONALLY LEFT BLANK

WIDEBAND FIXED ATTENUATOR FAMILY, DC - 25 GHz
HMC652LP2E / HMC653LP2E / HMC654LP2E / HMC655LP2E
Typical Applications

The HMC652LP2E - HMC655LP2E are ideal for:

- Fiber Optics
- Microwave Radio
- Military & Space
- Test & Measurement
- Scientific Instruments
- RF / Microwave Circuit Prototyping

Features

- 4 Attenuator Products:
- 2, 3, 4 & 6 dB Fixed Attenuation Levels
- Wide Bandwidth: DC - 25 GHz
- Excellent Attenuation Accuracy
- Power Handling: +25 dBm
- 6 Lead 2x2 mm SMT Package: 4 mm²

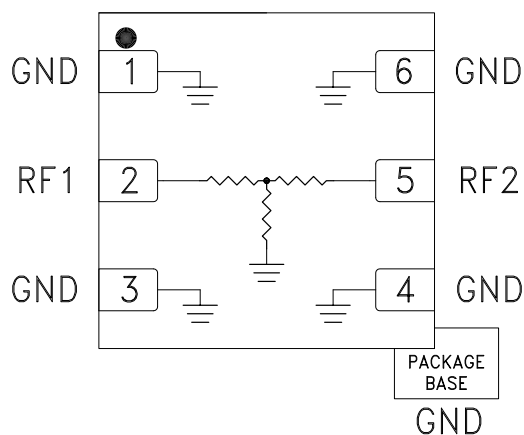
Functional Diagram

General Description

The HMC652LP2E / 653LP2E / 654LP2E / 655LP2E are a line of wideband fixed value SMT 50 Ohm matched attenuators which offer attenuation levels of 2, 3, 4 and 6 dB respectively. These passive attenuators are ideal for military, test equipment, and other wideband applications where extremely flat attenuation, and excellent VSWR vs. frequency are required.

These wideband attenuators handle up to +25 dBm of input power, and are compatible with high volume surface mount manufacturing techniques.

Electrical Specifications, $T_A = +25^\circ\text{C}$, 50 Ohm system

Part Number	Attenuator Value	Return Loss (Min.)	Return Loss (Typ.)	Attenuation Tolerance [1]	Temperature Coefficient (Typical) [2]	Units
						DC - 25
HMC652LP2E	2 dB	7.0	22.0	± 0.5	0.0004	dB
HMC653LP2E	3 dB	7.0	23.0	± 0.5	0.0006	dB
HMC654LP2E	4 dB	7.0	20.5	± 0.5	0.0006	dB
HMC655LP2E	6 dB	7.0	16.5	± 0.5	0.0004	dB

[1] Attenuation Tolerance is valid over temperature.

[2] Temperature Coefficient Units are dB/°C.

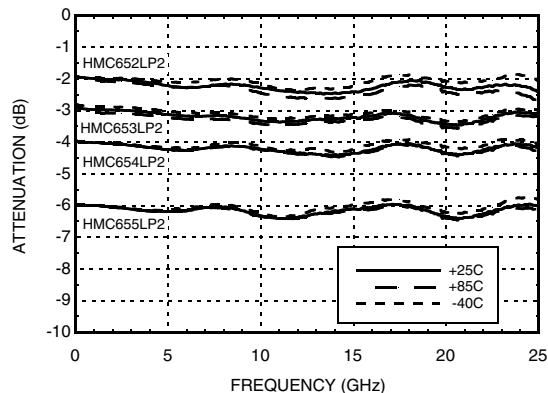
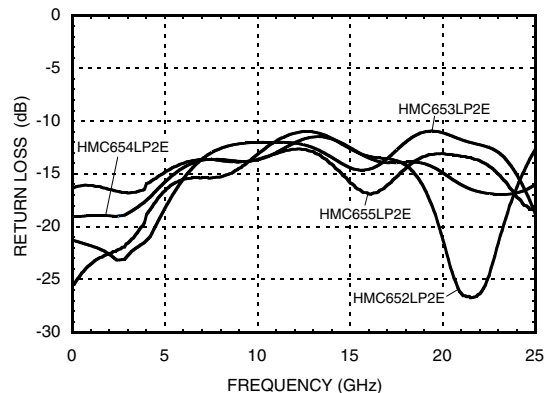
WIDEBAND FIXED ATTENUATOR FAMILY, DC - 25 GHz
HMC652LP2E / HMC653LP2E / HMC654LP2E / HMC655LP2E
Attenuation vs. Temperature

Return Loss

Absolute Maximum Ratings

Part Number	HMC652LP2E	HMC653LP2E	HMC654LP2E	HMC655LP2E	Units
RF Input Power (CW)	27	26	25	26	dBm
DC Voltage Terminated	5.6	5.2	4.9	5.2	V
DC Voltage Open	5.6	5.1	4.6	6.0	V
Storage Temperature	-65 to +150				°C
Operating Temperature	-40 to +85				°C
ESD Sensitivity (HBM)	Class 1A	Class 1A	Class 1A	Class 1A	

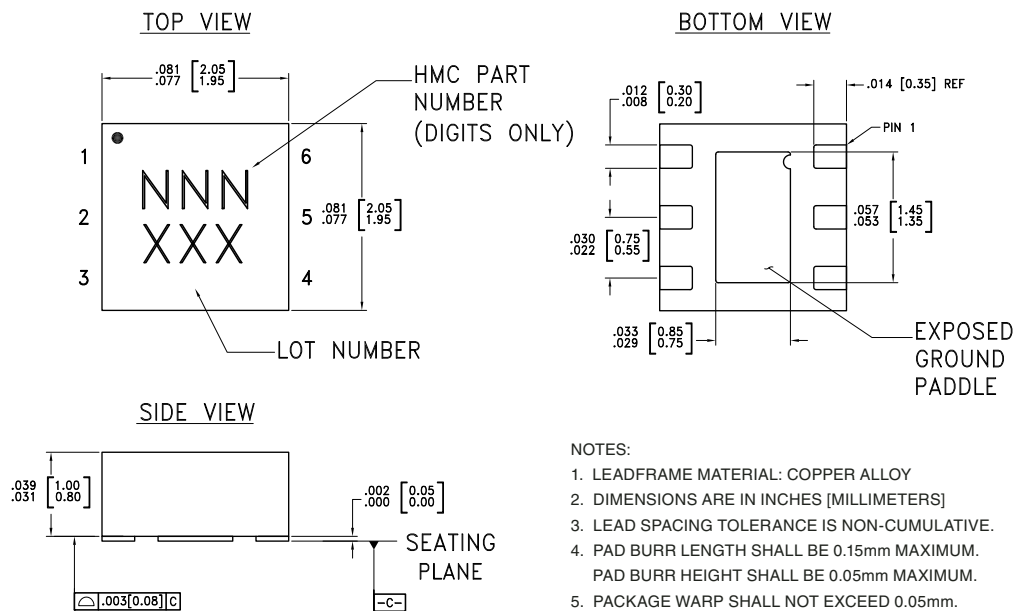

ELECTROSTATIC SENSITIVE DEVICE
OBSERVE HANDLING PRECAUTIONS

WIDEBAND FIXED ATTENUATOR FAMILY, DC - 25 GHz
HMC652LP2E / HMC653LP2E / HMC654LP2E / HMC655LP2E
Outline Drawing

NOTES:

1. LEADFRAME MATERIAL: COPPER ALLOY
2. DIMENSIONS ARE IN INCHES [MILLIMETERS]
3. LEAD SPACING TOLERANCE IS NON-CUMULATIVE.
4. PAD BURR LENGTH SHALL BE 0.15mm MAXIMUM.
PAD BURR HEIGHT SHALL BE 0.05mm MAXIMUM.
5. PACKAGE WARP SHALL NOT EXCEED 0.05mm.
6. ALL GROUND LEADS AND GROUND PADDLE MUST BE SOLDERED TO PCB RF GROUND.
7. REFER TO HITTITE APPLICATION NOTE FOR SUGGESTED LAND PATTERN.



Package Information

Part Number	Package Body Material	Lead Finish	MSL Rating	Package Marking ^[1]
HMC652LP2E through HMC655LP2E	RoHS-compliant Low Stress Injection Molded Plastic	100% matte Sn	MSL1 ^[2]	NNN XXX

[1] 3-Digit lot number XXX

[2] Max peak reflow temperature of 260 °C

Pin Descriptions

Pin Number	Function	Description	Interface Schematic
1, 3, 4, 6	GND	Package bottom must be connected to RF/DC ground.	
2, 5	RF1, RF2	This pin is DC coupled and matched to 50 Ohms. Use DC Blocking capacitors if the input / output signals have non-zero DC potential	

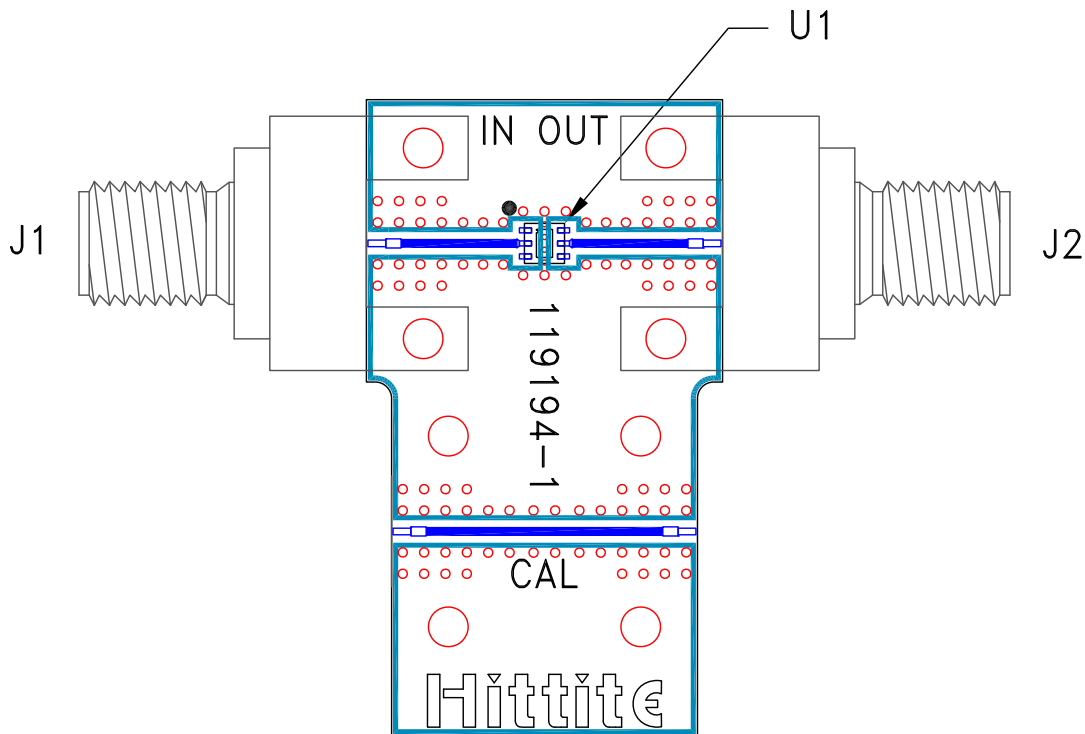
WIDEBAND FIXED ATTENUATOR FAMILY, DC - 25 GHz
HMC652LP2E / HMC653LP2E / HMC654LP2E / HMC655LP2E
Evaluation PCB

List of Materials for Evaluation PCB 119197 [1]

Item	Description
J1 - J2	PCB Mount K Connector
U1	HMC652LP2E through HMC655LP2E Passive Attenuators
PCB [2]	119194 Evaluation PCB

[1] Reference this number when ordering complete evaluation PCB

[2] Circuit Board Material: Rogers 4350

The circuit board used in the final application should be generated with proper RF circuit design techniques. Signal lines at the RF port should have 50 ohm impedance and the package ground leads and exposed paddle should be connected directly to the ground plane similar to that shown above. The evaluation circuit board shown above is available from Hittite Microwave Corporation upon request.

Mouser Electronics

Authorized Distributor

Click to View Pricing, Inventory, Delivery & Lifecycle Information:

[Analog Devices Inc.:](#)

[HMC652LP2E](#) [HMC653LP2E](#) [HMC654LP2E](#) [HMC653LP2ETR](#) [HMC652LP2ETR](#) [HMC654LP2ETR](#) [119197-HMC654LP2E](#) [119197-HMC652LP2E](#) [119197-HMC653LP2E](#)