

# 300nA NanoPower Voltage References

## ISL21080

The ISL21080 analog voltage references feature low supply voltage operation at ultra-low 310nA typ, 1.5µA max operating current. Additionally, the ISL21080 family features guaranteed initial accuracy as low as ±0.2% and 50ppm/°C temperature coefficient.

These references are ideal for general purpose portable applications to extend battery life at lower cost. The ISL21080 is provided in the industry standard 3 Ld SOT-23 pinout.

The ISL21080 output voltages can be used as precision voltage sources for voltage monitors, control loops, standby voltages for low power states for DSP, FPGA, Datapath Controllers, microcontrollers and other core voltages: 0.9V, 1.024V, 1.25V, 1.5V, 2.048V, 2.5V, 3.0V, 3.3V, 4.096V and 5.0V.

Special Note: Post-assembly x-ray inspection may lead to permanent changes in device output voltage and should be minimized or avoided. For further information, please see “Applications Information” on page 14 and [AN1533](#), “X-Ray Effects on Intersil FGA References”.

### Applications

- Energy harvesting applications
- Wireless sensor network applications
- Low power voltage sources for controllers, FPGA, ASICs or logic devices
- Battery management/monitoring
- Low power standby voltages
- Portable Instrumentation
- Consumer/medical electronics
- Wearable electronics
- Lower cost industrial and instrumentation
- Power regulation circuits
- Control loops and compensation networks
- LED/diode supply

## Features

- Reference output voltage . . . . . 0.900V, 1.024V, 1.250V, 1.500V, 2.048V, 2.500V, 3.000V, 3.300V, 4.096V, 5.000V
- Initial accuracy:
  - ISL21080-09 and -10 . . . . . ±0.7%
  - ISL21080-12 . . . . . ±0.6%
  - ISL21080-15 . . . . . ±0.5%
  - ISL21080-20 and -25 . . . . . ±0.3%
  - ISL21080-30, -33, -41, and -50 . . . . . ±0.2%
- Input voltage range:
  - ISL21080-09 . . . . . 2.0V to 5.5V
  - ISL21080-10, -12, -15, -20 and -25 . . . . . 2.7V to 5.5V
  - ISL21080-30 . . . . . 3.2V to 5.5V
  - ISL21080-33 . . . . . 3.5V to 5.5V
  - ISL21080-41 . . . . . 4.5V to 8.0V
  - ISL21080-50 . . . . . 5.5V to 8.0V
- Output voltage noise . . . . . 30µV<sub>p-p</sub> (0.1Hz to 10Hz)
- Supply current . . . . . 1.5µA (max)
- Tempco . . . . . 50ppm/°C
- Output current capability . . . . . ±7mA
- Operating temperature range . . . . . -40°C to +85°C
- Package . . . . . 3 Ld SOT-23
- Pb-Free (RoHS compliant)

## Related Literature

- See [AN1494](#), “Reflow and PC Board Assembly Effects on Intersil FGA References”
- See [AN1533](#), “X-Ray Effects on Intersil FGA References”
- See [AN1761](#), “ISL21080XXEV1Z User’s Guide”

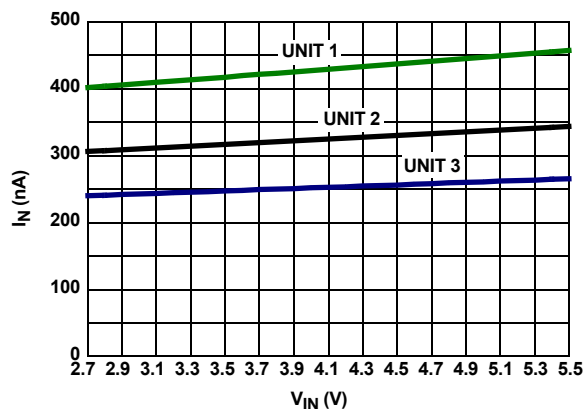
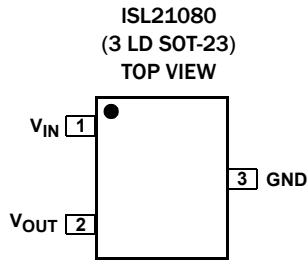

FIGURE 1. I<sub>IN</sub> vs V<sub>IN</sub>, 3 UNITS

# ISL21080

## Pin Configuration



## Pin Descriptions

PIN NUMBER	PIN NAME	DESCRIPTION
1	V <sub>IN</sub>	Input Voltage Connection.
2	V <sub>OUT</sub>	Voltage Reference Output
3	GND	Ground Connection

## Ordering Information

PART NUMBER (Notes 1, 2, 3)	PART MARKING (Note 4)	V <sub>OUT</sub> OPTION (V)	GRADE (%)	TEMP. RANGE (°C)	PACKAGE Tape & Reel (Pb-Free)	PKG. DWG. #
ISL21080DIH309Z-TK	BCLA	0.9	±0.7	-40 to +85	3 Ld SOT-23	P3.064
ISL21080DIH310Z-TK	BCMA	1.024	±0.7	-40 to +85	3 Ld SOT-23	P3.064
ISL21080DIH312Z-TK	BCNA	1.25	±0.6	-40 to +85	3 Ld SOT-23	P3.064
ISL21080CIH315Z-TK	BCDA	1.5	±0.5	-40 to +85	3 Ld SOT-23	P3.064
ISL21080CIH320Z-TK	BCPA	2.048	±0.3	-40 to +85	3 Ld SOT-23	P3.064
ISL21080CIH325Z-TK	BCRA	2.5	±0.3	-40 to +85	3 Ld SOT-23	P3.064
ISL21080CIH330Z-TK	BCSA	3.0	±0.2	-40 to +85	3 Ld SOT-23	P3.064
ISL21080CIH333Z-TK	BCTA	3.3	±0.2	-40 to +85	3 Ld SOT-23	P3.064
ISL21080CIH341Z-TK	BCVA	4.096	±0.2	-40 to +85	3 Ld SOT-23	P3.064
ISL21080CIH350Z-TK	BCWA	5.0	±0.2	-40 to +85	3 Ld SOT-23	P3.064

### NOTES:

1. Please refer to [TB347](#) for details on reel specifications.
2. These Intersil Pb-free plastic packaged products employ special Pb-free material sets, molding compounds/die attach materials, and 100% matte tin plate plus anneal (e3 termination finish, which is RoHS compliant and compatible with both SnPb and Pb-free soldering operations). Intersil Pb-free products are MSL classified at Pb-free peak reflow temperatures that meet or exceed the Pb-free requirements of IPC/JEDEC J STD-020.
3. For Moisture Sensitivity Level (MSL), please see device information page for [ISL21080](#). For more information on MSL please see techbrief [TB363](#).
4. The part marking is located on the bottom of the part.

# ISL21080

## Absolute Maximum Ratings

Max Voltage	
$V_{IN}$ to GND	-0.5V to +6.5V
$V_{IN}$ to GND (ISL21080-41 and 50 only)	-0.5V to +10V
$V_{OUT}$ to GND (10s)	-0.5V to $V_{OUT} + 1V$
$V_{OUT}$ to GND (10s)	
ISL21080-41 and 50 only	-0.5V to +5.1V
ESD Ratings	
Human Body Model (Tested to JESD22-A114)	5kV
Machine Model (Tested to JESD22-A115)	500V
Charged Device Model (Tested to JESD22-C101)	2kV
Latch Up (Tested per JESD-78B; Class 2, Level A)	100mA

## Thermal Information

Thermal Resistance (Typical)	$\theta_{JA}$ ( $^{\circ}\text{C}/\text{W}$ )	$\theta_{JC}$ ( $^{\circ}\text{C}/\text{W}$ )
3 Lead SOT-23 (Notes 6, 7)	275	110
Maximum Junction Temperature	+107 $^{\circ}\text{C}$	
Continuous Power Dissipation ( $T_A = +85^{\circ}\text{C}$ )	99mW	
Storage Temperature Range	-65 $^{\circ}\text{C}$ to +150 $^{\circ}\text{C}$	
Pb-Free Reflow Profile	see <a href="#">TB493</a>	

## Recommended Operating Conditions

Temperature	-40 $^{\circ}\text{C}$ to +85 $^{\circ}\text{C}$
Supply Voltage	2.7V to 5.5V

## Environmental Operating Conditions

X-Ray Exposure (Note 5)	10mRem
-------------------------	--------

**CAUTION:** Do not operate at or near the maximum ratings listed for extended periods of time. Exposure to such conditions may adversely impact product reliability and result in failures not covered by warranty.

### NOTES:

- Measured with no filtering, distance of 10" from source, intensity set to 55kV and 70mA current, 30s duration. Other exposure levels should be analyzed for Output Voltage drift effects. See "Applications Information" on page 14.
- $\theta_{JA}$  is measured with the component mounted on a high effective thermal conductivity test board in free air. See Tech Brief [TB379](#) for details.
- For  $\theta_{JC}$ , the "case temp" location is taken at the package top center.
- Post-reflow drift for the ISL21080 devices will range from 100 $\mu\text{V}$  to 1.0mV based on experimental results with devices on FR4 double sided boards. The design engineer must take this into account when considering the reference voltage after assembly.
- Post-assembly x-ray inspection may also lead to permanent changes in device output voltage and should be minimized or avoided. Initial accuracy can change 10mV or more under extreme radiation. Most inspection equipment will not affect the FGA reference voltage, but if x-ray inspection is required, it is advisable to monitor the reference output voltage to verify excessive shift has not occurred.

**Electrical Specifications (ISL21080-09,  $V_{OUT} = 0.9V$ )**  $V_{IN} = 3.0V$ ,  $T_A = -40^{\circ}\text{C}$  to +85 $^{\circ}\text{C}$ ,  $I_{OUT} = 0$ , unless otherwise specified. **Boldface limits apply over the operating temperature range, -40 $^{\circ}\text{C}$  to +85 $^{\circ}\text{C}$ .**

PARAMETER	DESCRIPTION	CONDITIONS	MIN (Note 13)	TYP	MAX (Note 13)	UNIT
$V_{OUT}$	Output Voltage			0.9		V
$V_{OA}$	$V_{OUT}$ Accuracy @ $T_A = +25^{\circ}\text{C}$ (Notes 8, 9)		-0.7		+0.7	%
TC $V_{OUT}$	Output Voltage Temperature Coefficient (Note 10)				50	ppm/ $^{\circ}\text{C}$
$V_{IN}$	Input Voltage Range		<b>2.0</b>		<b>5.5</b>	V
$I_{IN}$	Supply Current			0.35	<b>1.5</b>	$\mu\text{A}$
$\Delta V_{OUT}/\Delta V_{IN}$	Line Regulation	$2V \leq V_{IN} \leq 5.5V$		30	<b>350</b>	$\mu\text{V}/\text{V}$
$\Delta V_{OUT}/\Delta I_{OUT}$	Load Regulation	Sourcing: $0\text{mA} \leq I_{OUT} \leq 10\text{mA}$		6	<b>100</b>	$\mu\text{V}/\text{mA}$
		Sinking: $-10\text{mA} \leq I_{OUT} \leq 0\text{mA}$		23	<b>350</b>	$\mu\text{V}/\text{mA}$
$I_{SC}$	Short Circuit Current	$T_A = +25^{\circ}\text{C}$ , $V_{OUT}$ tied to GND		30		mA
$t_R$	Turn-on Settling Time	$V_{OUT} = \pm 0.1\%$ with no load		1		ms
	Ripple Rejection	$f = 120\text{Hz}$		-40		dB
$\epsilon_N$	Output Voltage Noise	$0.1\text{Hz} \leq f \leq 10\text{Hz}$		40		$\mu\text{V}_{P-P}$
$V_N$	Broadband Voltage Noise	$10\text{Hz} \leq f \leq 1\text{kHz}$		10		$\mu\text{V}_{RMS}$
		Noise Density	$f = 1\text{kHz}$		1.1	$\mu\text{V}/\sqrt{\text{Hz}}$
$\Delta V_{OUT}/\Delta T_A$	Thermal Hysteresis (Note 11)	$\Delta T_A = +125^{\circ}\text{C}$		100		ppm
$\Delta V_{OUT}/\Delta t$	Long Term Stability (Note 12)	$T_A = +25^{\circ}\text{C}$		60		ppm

# ISL21080

**Electrical Specifications (ISL21080-10,  $V_{OUT} = 1.024V$ )**  $V_{IN} = 3.0V$ ,  $T_A = -40^{\circ}C$  to  $+85^{\circ}C$ ,  $I_{OUT} = 0$ , unless otherwise specified. **Boldface limits apply over the operating temperature range,  $-40^{\circ}C$  to  $+85^{\circ}C$ .**

PARAMETER	DESCRIPTION	CONDITIONS	MIN (Note 13)	TYP	MAX (Note 13)	UNIT
$V_{OUT}$	Output Voltage			1.024		V
$V_{OA}$	$V_{OUT}$ Accuracy @ $T_A = +25^{\circ}C$ (Notes 8, 9)		-0.7		+0.7	%
TC $V_{OUT}$	Output Voltage Temperature Coefficient (Note 10)				50	ppm/ $^{\circ}C$
$V_{IN}$	Input Voltage Range		<b>2.7</b>		<b>5.5</b>	V
$I_{IN}$	Supply Current			0.31	<b>1.5</b>	$\mu A$
$\Delta V_{OUT}/\Delta V_{IN}$	Line Regulation	$2.7V \leq V_{IN} \leq 5.5V$		80	<b>350</b>	$\mu V/V$
$\Delta V_{OUT}/\Delta I_{OUT}$	Load Regulation	Sourcing: $0mA \leq I_{OUT} \leq 7mA$		25	<b>100</b>	$\mu V/mA$
		Sinking: $-7mA \leq I_{OUT} \leq 0mA$		50	<b>350</b>	$\mu V/mA$
$I_{SC}$	Short Circuit Current	$T_A = +25^{\circ}C$ , $V_{OUT}$ tied to GND		50		mA
$t_R$	Turn-on Settling Time	$V_{OUT} = \pm 0.1\%$ with no load		4		ms
	Ripple Rejection	$f = 120Hz$		-40		dB
$e_N$	Output Voltage Noise	$0.1Hz \leq f \leq 10Hz$		30		$\mu V_{p,p}$
$V_N$	Broadband Voltage Noise	$10Hz \leq f \leq 1kHz$		52		$\mu V_{RMS}$
	Noise Density	$f = 1kHz$		2.2		$\mu V/\sqrt{Hz}$
$\Delta V_{OUT}/\Delta T_A$	Thermal Hysteresis (Note 11)	$\Delta T_A = +165^{\circ}C$		100		ppm
$\Delta V_{OUT}/\Delta t$	Long Term Stability (Note 12)	$T_A = +25^{\circ}C$		50		ppm

**Electrical Specifications (ISL21080-12,  $V_{OUT} = 1.25V$ )**  $V_{IN} = 3.0V$ ,  $T_A = -40^{\circ}C$  to  $+85^{\circ}C$ ,  $I_{OUT} = 0$ , unless otherwise specified. **Boldface limits apply over the operating temperature range,  $-40^{\circ}C$  to  $+85^{\circ}C$ .**

PARAMETER	DESCRIPTION	CONDITIONS	MIN (Note 13)	TYP	MAX (Note 13)	UNIT
$V_{OUT}$	Output Voltage			1.25		V
$V_{OA}$	$V_{OUT}$ Accuracy @ $T_A = +25^{\circ}C$ (Notes 8, 9)		-0.6		+0.6	%
TC $V_{OUT}$	Output Voltage Temperature Coefficient (Note 10)				50	ppm/ $^{\circ}C$
$V_{IN}$	Input Voltage Range		<b>2.7</b>		<b>5.5</b>	V
$I_{IN}$	Supply Current			0.31	<b>1.5</b>	$\mu A$
$\Delta V_{OUT}/\Delta V_{IN}$	Line Regulation	$2.7V \leq V_{IN} \leq 5.5V$		80	<b>350</b>	$\mu V/V$
$\Delta V_{OUT}/\Delta I_{OUT}$	Load Regulation	Sourcing: $0mA \leq I_{OUT} \leq 7mA$		25	<b>100</b>	$\mu V/mA$
		Sinking: $-7mA \leq I_{OUT} \leq 0mA$		50	<b>350</b>	$\mu V/mA$
$I_{SC}$	Short Circuit Current	$T_A = +25^{\circ}C$ , $V_{OUT}$ tied to GND		50		mA
$t_R$	Turn-on Settling Time	$V_{OUT} = \pm 0.1\%$ with no load		4		ms
	Ripple Rejection	$f = 120Hz$		-40		dB
$e_N$	Output Voltage Noise	$0.1Hz \leq f \leq 10Hz$		30		$\mu V_{p,p}$
$V_N$	Broadband Voltage Noise	$10Hz \leq f \leq 1kHz$		52		$\mu V_{RMS}$
	Noise Density	$f = 1kHz$		1.1		$\mu V/\sqrt{Hz}$
$\Delta V_{OUT}/\Delta T_A$	Thermal Hysteresis (Note 11)	$\Delta T_A = +165^{\circ}C$		100		ppm
$\Delta V_{OUT}/\Delta t$	Long Term Stability (Note 12)	$T_A = +25^{\circ}C$		50		ppm

# ISL21080

**Electrical Specifications (ISL21080-15,  $V_{OUT} = 1.5V$ )**  $V_{IN} = 3.0V$ ,  $T_A = -40^{\circ}C$  to  $+85^{\circ}C$ ,  $I_{OUT} = 0$ , unless otherwise specified. **Boldface limits apply over the operating temperature range,  $-40^{\circ}C$  to  $+85^{\circ}C$ .**

PARAMETER	DESCRIPTION	CONDITIONS	MIN (Note 13)	TYP	MAX (Note 13)	UNIT
$V_{OUT}$	Output Voltage			1.5		V
$V_{OA}$	$V_{OUT}$ Accuracy @ $T_A = +25^{\circ}C$ (Notes 8, 9)		-0.5		+0.5	%
TC $V_{OUT}$	Output Voltage Temperature Coefficient (Note 10)				<b>50</b>	ppm/ $^{\circ}C$
$V_{IN}$	Input Voltage Range		<b>2.7</b>		<b>5.5</b>	V
$I_{IN}$	Supply Current			0.31	<b>1.5</b>	$\mu A$
$\Delta V_{OUT} / \Delta V_{IN}$	Line Regulation	$2.7V \leq V_{IN} \leq 5.5V$		80	<b>350</b>	$\mu V/V$
$\Delta V_{OUT} / \Delta I_{OUT}$	Load Regulation	Sourcing: $0mA \leq I_{OUT} \leq 7mA$		10	<b>100</b>	$\mu V/mA$
		Sinking: $-7mA \leq I_{OUT} \leq 0mA$		50	<b>350</b>	$\mu V/mA$
$I_{SC}$	Short Circuit Current	$T_A = +25^{\circ}C$ , $V_{OUT}$ tied to GND		50		mA
$t_R$	Turn-on Settling Time	$V_{OUT} = \pm 0.1\%$ with no load		4		ms
	Ripple Rejection	$f = 120Hz$		-40		dB
$e_N$	Output Voltage Noise	$0.1Hz \leq f \leq 10Hz$		30		$\mu V_{p-p}$
$V_N$	Broadband Voltage Noise	$10Hz \leq f \leq 1kHz$		52		$\mu V_{RMS}$
	Noise Density	$f = 1kHz$		1.1		$\mu V/\sqrt{Hz}$
$\Delta V_{OUT} / \Delta T_A$	Thermal Hysteresis (Note 11)	$\Delta T_A = +165^{\circ}C$		100		ppm
$\Delta V_{OUT} / \Delta t$	Long Term Stability (Note 12)	$T_A = +25^{\circ}C$		50		ppm

**Electrical Specifications (ISL21080-20,  $V_{OUT} = 2.048V$ )**  $V_{IN} = 3.0V$ ,  $T_A = -40^{\circ}C$  to  $+85^{\circ}C$ ,  $I_{OUT} = 0$ , unless otherwise specified. **Boldface limits apply over the operating temperature range,  $-40^{\circ}C$  to  $+85^{\circ}C$ .**

PARAMETER	DESCRIPTION	CONDITIONS	MIN (Note 13)	TYP	MAX (Note 13)	UNIT
$V_{OUT}$	Output Voltage			2.048		V
$V_{OA}$	$V_{OUT}$ Accuracy @ $T_A = +25^{\circ}C$ (Notes 8, 9)		-0.3		+0.3	%
TC $V_{OUT}$	Output Voltage Temperature Coefficient (Note 10)				<b>50</b>	ppm/ $^{\circ}C$
$V_{IN}$	Input Voltage Range		<b>2.7</b>		<b>5.5</b>	V
$I_{IN}$	Supply Current			0.31	<b>1.5</b>	$\mu A$
$\Delta V_{OUT} / \Delta V_{IN}$	Line Regulation	$2.7V \leq V_{IN} \leq 5.5V$		80	<b>350</b>	$\mu V/V$
$\Delta V_{OUT} / \Delta I_{OUT}$	Load Regulation	Sourcing: $0mA \leq I_{OUT} \leq 7mA$		25	<b>100</b>	$\mu V/mA$
		Sinking: $-7mA \leq I_{OUT} \leq 0mA$		50	<b>350</b>	$\mu V/mA$
$I_{SC}$	Short Circuit Current	$T_A = +25^{\circ}C$ , $V_{OUT}$ tied to GND		50		mA
$t_R$	Turn-on Settling Time	$V_{OUT} = \pm 0.1\%$ with no load		4		ms
	Ripple Rejection	$f = 120Hz$		-40		dB
$e_N$	Output Voltage Noise	$0.1Hz \leq f \leq 10Hz$		30		$\mu V_{p-p}$
$V_N$	Broadband Voltage Noise	$10Hz \leq f \leq 1kHz$		52		$\mu V_{RMS}$
	Noise Density	$f = 1kHz$		1.1		$\mu V/\sqrt{Hz}$
$\Delta V_{OUT} / \Delta T_A$	Thermal Hysteresis (Note 11)	$\Delta T_A = +165^{\circ}C$		100		ppm
$\Delta V_{OUT} / \Delta t$	Long Term Stability (Note 12)	$T_A = +25^{\circ}C$		50		ppm

# ISL21080

**Electrical Specifications (ISL21080-25,  $V_{OUT} = 2.5V$ )**  $V_{IN} = 3.0V$ ,  $T_A = -40^\circ C$  to  $+85^\circ C$ ,  $I_{OUT} = 0$ , unless otherwise specified. **Boldface limits apply over the operating temperature range,  $-40^\circ C$  to  $+85^\circ C$ .**

PARAMETER	DESCRIPTION	CONDITIONS	MIN (Note 13)	TYP	MAX (Note 13)	UNIT
$V_{OUT}$	Output Voltage			2.5		V
$V_{OA}$	$V_{OUT}$ Accuracy @ $T_A = +25^\circ C$ (Notes 8, 9)		-0.3		+0.3	%
TC $V_{OUT}$	Output Voltage Temperature Coefficient (Note 10)				50	ppm/ $^\circ C$
$V_{IN}$	Input Voltage Range		<b>2.7</b>		<b>5.5</b>	V
$I_{IN}$	Supply Current			0.31	<b>1.5</b>	$\mu A$
$\Delta V_{OUT} / \Delta V_{IN}$	Line Regulation	$2.7V \leq V_{IN} \leq 5.5V$		80	<b>350</b>	$\mu V/V$
$\Delta V_{OUT} / \Delta I_{OUT}$	Load Regulation	Sourcing: $0mA \leq I_{OUT} \leq 7mA$		25	<b>100</b>	$\mu V/mA$
		Sinking: $-7mA \leq I_{OUT} \leq 0mA$		50	<b>350</b>	$\mu V/mA$
$I_{SC}$	Short Circuit Current	$T_A = +25^\circ C$ , $V_{OUT}$ tied to GND		50		mA
$t_R$	Turn-on Settling Time	$V_{OUT} = \pm 0.1\%$ with no load		4		ms
	Ripple Rejection	$f = 120Hz$		-40		dB
$e_N$	Output Voltage Noise	$0.1Hz \leq f \leq 10Hz$		30		$\mu V_{P-P}$
$V_N$	Broadband Voltage Noise	$10Hz \leq f \leq 1kHz$		52		$\mu V_{RMS}$
	Noise Density	$f = 1kHz$		1.1		$\mu V/\sqrt{Hz}$
$\Delta V_{OUT} / \Delta T_A$	Thermal Hysteresis (Note 11)	$\Delta T_A = +165^\circ C$		100		ppm
$\Delta V_{OUT} / \Delta t$	Long Term Stability (Note 12)	$T_A = +25^\circ C$		50		ppm

**Electrical Specifications (ISL21080-30,  $V_{OUT} = 3.0V$ )**  $V_{IN} = 5.0V$ ,  $T_A = -40^\circ C$  to  $+85^\circ C$ ,  $I_{OUT} = 0$ , unless otherwise specified. **Boldface limits apply over the operating temperature range,  $-40^\circ C$  to  $+85^\circ C$ .**

PARAMETER	DESCRIPTION	CONDITIONS	MIN (Note 13)	TYP	MAX (Note 13)	UNIT
$V_{OUT}$	Output Voltage			3.0		V
$V_{OA}$	$V_{OUT}$ Accuracy @ $T_A = +25^\circ C$ (Notes 8, 9)		-0.2		+0.2	%
TC $V_{OUT}$	Output Voltage Temperature Coefficient (Note 10)				<b>50</b>	ppm/ $^\circ C$
$V_{IN}$	Input Voltage Range		<b>3.2</b>		<b>5.5</b>	V
$I_{IN}$	Supply Current			0.31	<b>1.5</b>	$\mu A$
$\Delta V_{OUT} / \Delta V_{IN}$	Line Regulation	$3.2V \leq V_{IN} \leq 5.5V$		80	<b>350</b>	$\mu V/V$
$\Delta V_{OUT} / \Delta I_{OUT}$	Load Regulation	Sourcing: $0mA \leq I_{OUT} \leq 7mA$		25	<b>100</b>	$\mu V/mA$
		Sinking: $-7mA \leq I_{OUT} \leq 0mA$		50	<b>350</b>	$\mu V/mA$
$I_{SC}$	Short Circuit Current	$T_A = +25^\circ C$ , $V_{OUT}$ tied to GND		50		mA
$t_R$	Turn-on Settling Time	$V_{OUT} = \pm 0.1\%$ with no load		4		ms
	Ripple Rejection	$f = 120Hz$		-40		dB
$e_N$	Output Voltage Noise	$0.1Hz \leq f \leq 10Hz$		30		$\mu V_{P-P}$
$V_N$	Broadband Voltage Noise	$10Hz \leq f \leq 1kHz$		52		$\mu V_{RMS}$
	Noise Density	$f = 1kHz$		1.1		$\mu V/\sqrt{Hz}$
$\Delta V_{OUT} / \Delta T_A$	Thermal Hysteresis (Note 11)	$\Delta T_A = +165^\circ C$		100		ppm
$\Delta V_{OUT} / \Delta t$	Long Term Stability (Note 12)	$T_A = +25^\circ C$		50		ppm

# ISL21080

**Electrical Specifications (ISL21080-33,  $V_{OUT} = 3.3V$ )**  $V_{IN} = 5.0V$ ,  $T_A = -40^\circ C$  to  $+85^\circ C$ ,  $I_{OUT} = 0$ , unless otherwise specified. **Boldface limits apply over the operating temperature range,  $-40^\circ C$  to  $+85^\circ C$ .**

PARAMETER	DESCRIPTION	CONDITIONS	MIN (Note 13)	TYP	MAX (Note 13)	UNIT
$V_{OUT}$	Output Voltage			3.3		V
$V_{OA}$	$V_{OUT}$ Accuracy @ $T_A = +25^\circ C$ (Notes 8, 9)		-0.2		+0.2	%
TC $V_{OUT}$	Output Voltage Temperature Coefficient (Note 10)				50	ppm/ $^\circ C$
$V_{IN}$	Input Voltage Range		<b>3.5</b>		<b>5.5</b>	V
$I_{IN}$	Supply Current			0.31	<b>1.5</b>	$\mu A$
$\Delta V_{OUT} / \Delta V_{IN}$	Line Regulation	$3.5 V \leq V_{IN} \leq 5.5 V$		80	<b>350</b>	$\mu V/V$
$\Delta V_{OUT} / \Delta I_{OUT}$	Load Regulation	Sourcing: $0mA \leq I_{OUT} \leq 10mA$		25	<b>100</b>	$\mu V/mA$
		Sinking: $-10mA \leq I_{OUT} \leq 0mA$		50	<b>350</b>	$\mu V/mA$
$I_{SC}$	Short Circuit Current	$T_A = +25^\circ C$ , $V_{OUT}$ tied to GND		50		mA
$t_R$	Turn-on Settling Time	$V_{OUT} = \pm 0.1\%$ with no load		4		ms
	Ripple Rejection	$f = 120Hz$		-40		dB
$e_N$	Output Voltage Noise	$0.1Hz \leq f \leq 10Hz$		30		$\mu V_{P-P}$
$V_N$	Broadband Voltage Noise	$10Hz \leq f \leq 1kHz$		52		$\mu V_{RMS}$
	Noise Density	$f = 1kHz$		1.1		$\mu V/\sqrt{Hz}$
$\Delta V_{OUT} / \Delta T_A$	Thermal Hysteresis (Note 11)	$\Delta T_A = +165^\circ C$		100		ppm
$\Delta V_{OUT} / \Delta t$	Long Term Stability (Note 12)	$T_A = +25^\circ C$		50		ppm

**Electrical Specifications (ISL21080-41  $V_{OUT} = 4.096V$ )**  $V_{IN} = 5.0V$ ,  $T_A = -40^\circ C$  to  $+85^\circ C$ ,  $I_{OUT} = 0$ , unless otherwise specified. **Boldface limits apply over the operating temperature range,  $-40^\circ C$  to  $+85^\circ C$ .**

PARAMETER	DESCRIPTION	CONDITIONS	MIN (Note 13)	TYP	MAX (Note 13)	UNIT
$V_{OUT}$	Output Voltage			4.096		V
$V_{OA}$	$V_{OUT}$ Accuracy @ $T_A = +25^\circ C$ (Notes 8, 9)		-0.2		+0.2	%
TC $V_{OUT}$	Output Voltage Temperature Coefficient (Note 10)				<b>50</b>	ppm/ $^\circ C$
$V_{IN}$	Input Voltage Range		<b>4.5</b>		<b>8.0</b>	V
$I_{IN}$	Supply Current			0.5	<b>1.5</b>	$\mu A$
$\Delta V_{OUT} / \Delta V_{IN}$	Line Regulation	$4.5 V \leq V_{IN} \leq 8.0 V$		80	<b>350</b>	$\mu V/V$
$\Delta V_{OUT} / \Delta I_{OUT}$	Load Regulation	Sourcing: $0mA \leq I_{OUT} \leq 10mA$		10	<b>100</b>	$\mu V/mA$
		Sinking: $-10mA \leq I_{OUT} \leq 0mA$		20	<b>350</b>	$\mu V/mA$
$I_{SC}$	Short Circuit Current	$T_A = +25^\circ C$ , $V_{OUT}$ tied to GND		80		mA
$t_R$	Turn-on Settling Time	$V_{OUT} = \pm 0.1\%$ with no load		4		ms
	Ripple Rejection	$f = 120Hz$		-40		dB
$e_N$	Output Voltage Noise	$0.1Hz \leq f \leq 10Hz$		30		$\mu V_{P-P}$
$V_N$	Broadband Voltage Noise	$10Hz \leq f \leq 1kHz$		52		$\mu V_{RMS}$
	Noise Density	$f = 1kHz$		1.1		$\mu V/\sqrt{Hz}$
$\Delta V_{OUT} / \Delta T_A$	Thermal Hysteresis (Note 11)	$\Delta T_A = +165^\circ C$		100		ppm
$\Delta V_{OUT} / \Delta t$	Long Term Stability (Note 12)	$T_A = +25^\circ C$		50		ppm

# ISL21080

**Electrical Specifications (ISL21080-50  $V_{OUT} = 5.0V$ )**  $V_{IN} = 6.5V$ ,  $T_A = -40^{\circ}C$  to  $+85^{\circ}C$ ,  $I_{OUT} = 0$ , unless otherwise specified. **Boldface limits apply over the operating temperature range,  $-40^{\circ}C$  to  $+85^{\circ}C$ .**

PARAMETER	DESCRIPTION	CONDITIONS	MIN (Note 13)	TYP	MAX (Note 13)	UNIT
$V_{OUT}$	Output Voltage			5.0		V
$V_{OA}$	$V_{OUT}$ Accuracy @ $T_A = +25^{\circ}C$ (Notes 8, 9)		-0.2		+0.2	%
TC $V_{OUT}$	Output Voltage Temperature Coefficient (Note 10)				<b>50</b>	ppm/ $^{\circ}C$
$V_{IN}$	Input Voltage Range		<b>5.5</b>		<b>8.0</b>	V
$I_{IN}$	Supply Current			0.5	<b>1.5</b>	$\mu A$
$\Delta V_{OUT}/\Delta V_{IN}$	Line Regulation	$5.5V \leq V_{IN} \leq 8.0V$		80	<b>350</b>	$\mu V/V$
$\Delta V_{OUT}/\Delta I_{OUT}$	Load Regulation	Sourcing: $0mA \leq I_{OUT} \leq 10mA$		10	<b>100</b>	$\mu V/mA$
		Sinking: $-10mA \leq I_{OUT} \leq 0mA$		20	<b>350</b>	$\mu V/mA$
$I_{SC}$	Short Circuit Current	$T_A = +25^{\circ}C$ , $V_{OUT}$ tied to GND		80		mA
$t_R$	Turn-on Settling Time	$V_{OUT} = \pm 0.1\%$ with no load		4		ms
	Ripple Rejection	$f = 120Hz$		-40		dB
$e_N$	Output Voltage Noise	$0.1Hz \leq f \leq 10Hz$		30		$\mu V_{P-P}$
$V_N$	Broadband Voltage Noise	$10Hz \leq f \leq 1kHz$		52		$\mu V_{RMS}$
		Noise Density	$f = 1kHz$		1.1	$\mu V/\sqrt{Hz}$
$\Delta V_{OUT}/\Delta T_A$	Thermal Hysteresis (Note 11)	$\Delta T_A = +165^{\circ}C$		100		ppm
$\Delta V_{OUT}/\Delta t$	Long Term Stability (Note 12)	$T_A = +25^{\circ}C$		50		ppm

## NOTES:

- Over the specified temperature range. Temperature coefficient is measured by the box method whereby the change in  $V_{OUT}$  is divided by the temperature range; in this case,  $-40^{\circ}C$  to  $+85^{\circ}C = +125^{\circ}C$ .
- Thermal Hysteresis is the change of  $V_{OUT}$  measured @  $T_A = +25^{\circ}C$  after temperature cycling over a specified range,  $\Delta T_A$ .  $V_{OUT}$  is read initially at  $T_A = +25^{\circ}C$  for the device under test. The device is temperature cycled and a second  $V_{OUT}$  measurement is taken at  $+25^{\circ}C$ . The difference between the initial  $V_{OUT}$  reading and the second  $V_{OUT}$  reading is then expressed in ppm. For  $\Delta T_A = +125^{\circ}C$ , the device under test is cycled from  $+25^{\circ}C$  to  $+85^{\circ}C$  to  $-40^{\circ}C$  to  $+25^{\circ}C$ .
- Long term drift is logarithmic in nature and diminishes over time. Drift after the first 1000 hours will be approximately  $10ppm/\sqrt{1khrs}$ .
- Parameters with MIN and/or MAX limits are 100% tested at  $+25^{\circ}C$ , unless otherwise specified. Temperature limits established by characterization and are not production tested.

## Typical Performance Characteristics Curves

$V_{OUT} = 0.9V$ ,  $V_{IN} = 3.0V$ ,  $I_{OUT} = 0mA$ ,  $T_A = +25^{\circ}C$

unless otherwise specified.

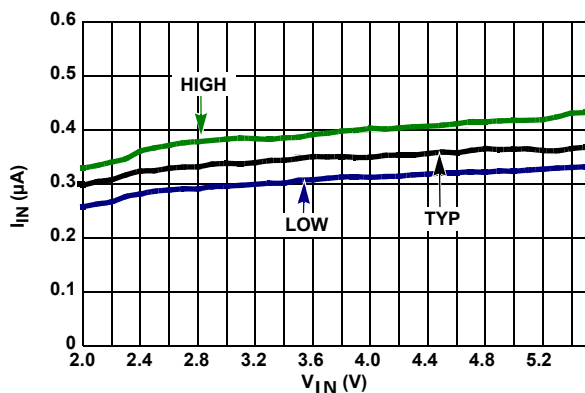

FIGURE 2.  $I_{IN}$  vs  $V_{IN}$ , 3 UNITS

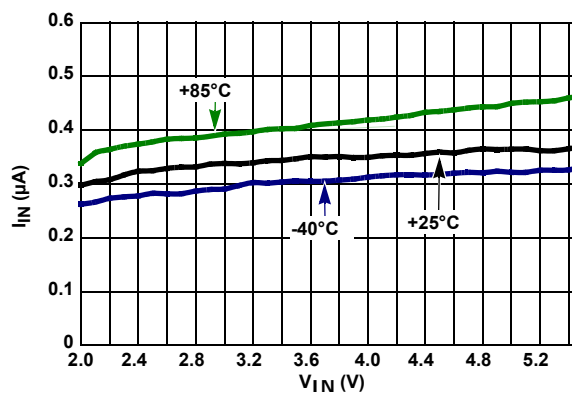

FIGURE 3.  $I_{IN}$  vs  $V_{IN}$  OVER-TEMPERATURE



## Typical Performance Characteristics Curves

$V_{OUT} = 0.9V$ ,  $V_{IN} = 3.0V$ ,  $I_{OUT} = 0mA$ ,  $T_A = +25^\circ C$

unless otherwise specified. (Continued)

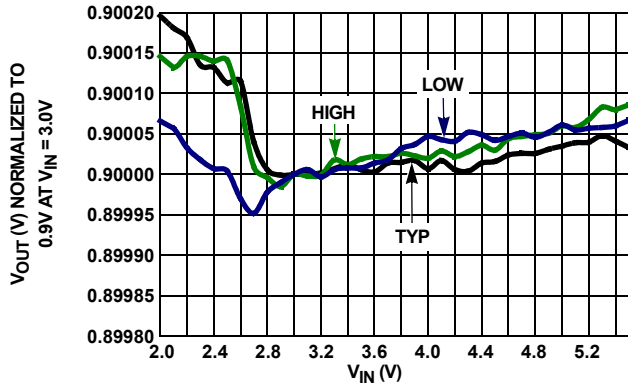

FIGURE 4. LINE REGULATION, 3 UNITS

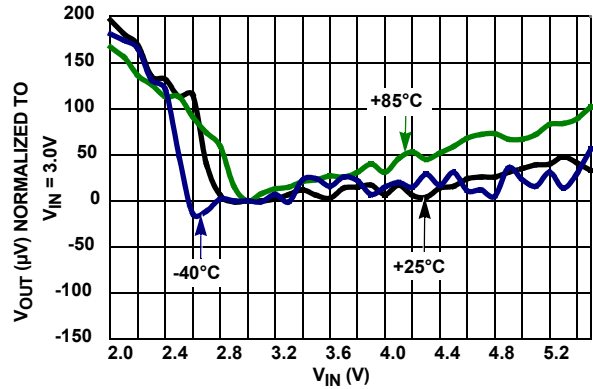

FIGURE 5. LINE REGULATION OVER-TEMPERATURE

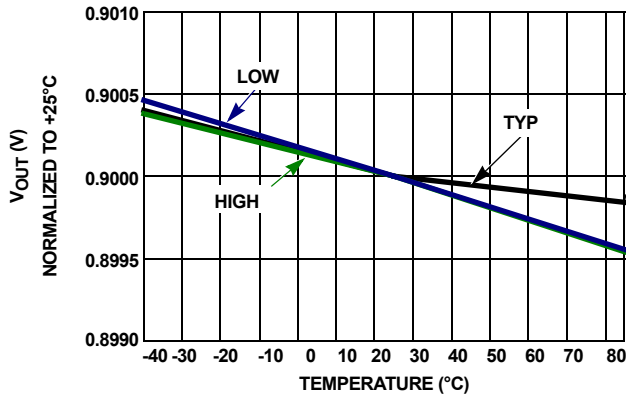

FIGURE 6.  $V_{OUT}$  vs TEMPERATURE NORMALIZED to  $+25^\circ C$

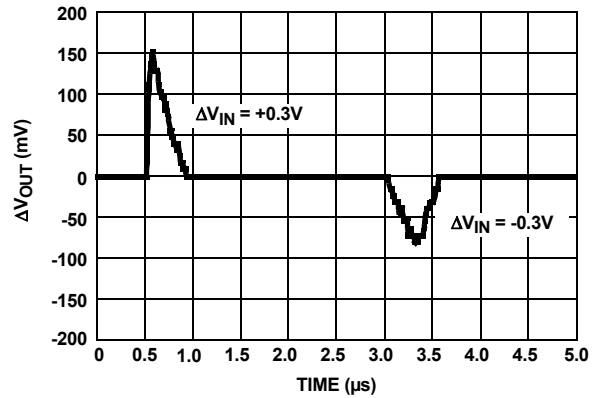

FIGURE 7. LINE TRANSIENT RESPONSE, WITH CAPACITIVE LOAD

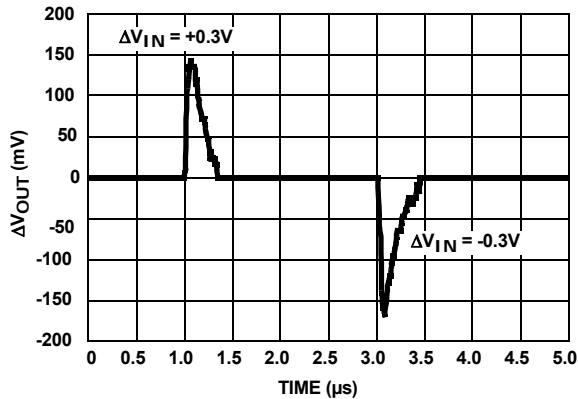

FIGURE 8. LINE TRANSIENT RESPONSE

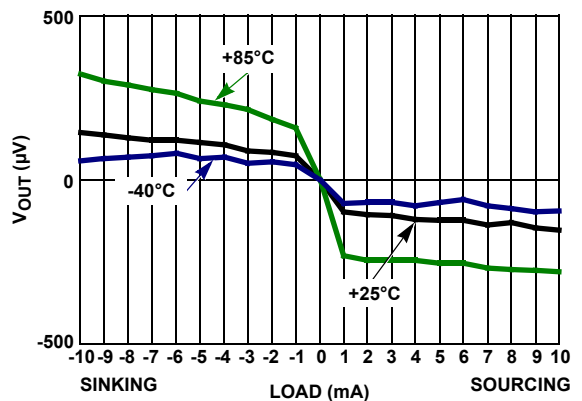

FIGURE 9. LOAD REGULATION OVER-TEMPERATURE

# ISL21080

## Typical Performance Characteristics Curves

$V_{OUT} = 0.9V$ ,  $V_{IN} = 3.0V$ ,  $I_{OUT} = 0mA$ ,  $T_A = +25^\circ C$

unless otherwise specified. (Continued)

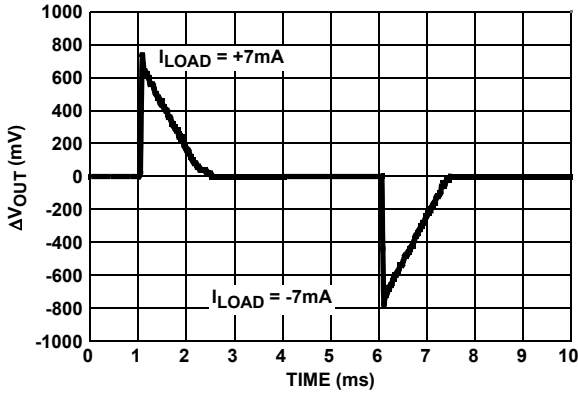

FIGURE 10. LOAD TRANSIENT RESPONSE

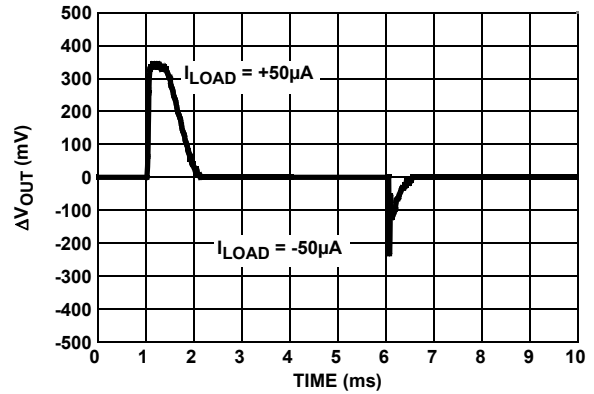

FIGURE 11. LOAD TRANSIENT RESPONSE

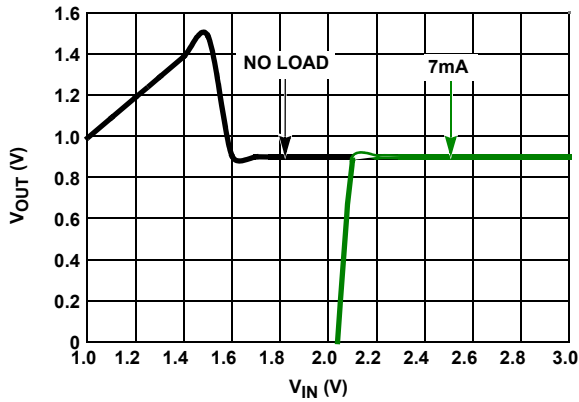

FIGURE 12. DROPOUT

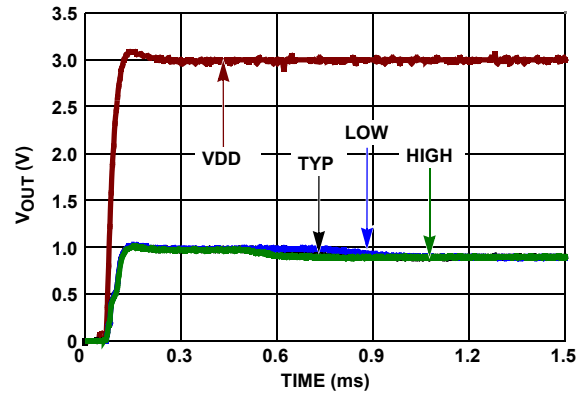

FIGURE 13. TURN-ON TIME

## Typical Performance Characteristics Curves

$V_{OUT} = 1.5V$ ,  $V_{IN} = 3.0V$ ,  $I_{OUT} = 0mA$ ,  $T_A = +25^\circ C$

unless otherwise specified.

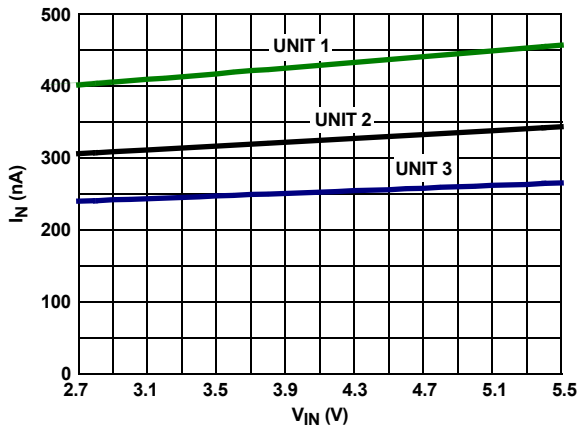

FIGURE 14.  $I_{IN}$  vs  $V_{IN}$ , 3 UNITS

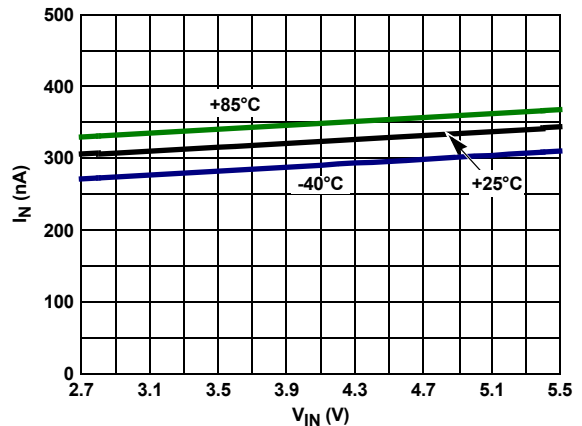

FIGURE 15.  $I_{IN}$  vs  $V_{IN}$  OVER-TEMPERATURE

Typical Performance Characteristics Curves

$V_{OUT} = 1.5V, V_{IN} = 3.0V, I_{OUT} = 0mA, T_A = +25^\circ C$

unless otherwise specified. (Continued)

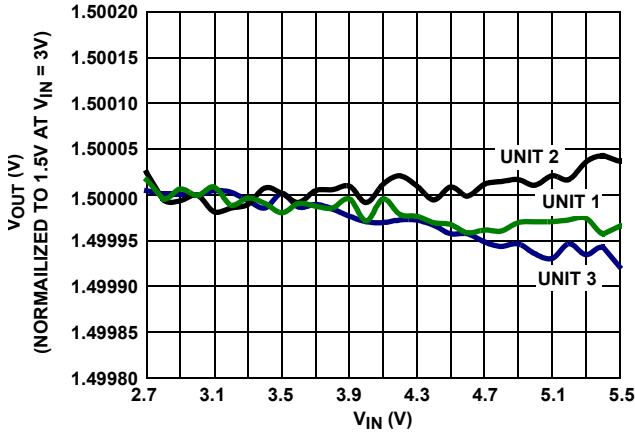

FIGURE 16. LINE REGULATION, 3 UNITS

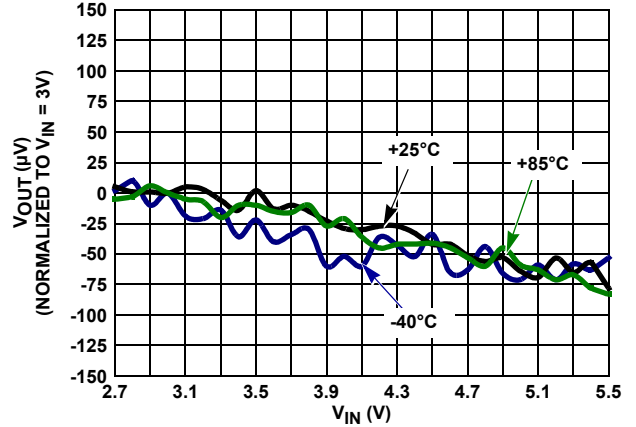

FIGURE 17. LINE REGULATION OVER-TEMPERATURE

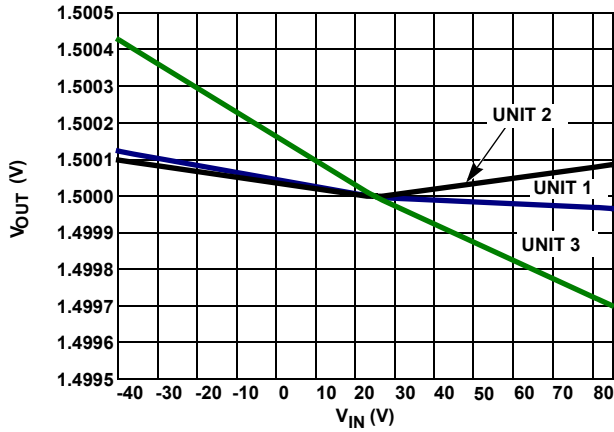

FIGURE 18.  $V_{OUT}$  vs TEMPERATURE NORMALIZED to +25°C

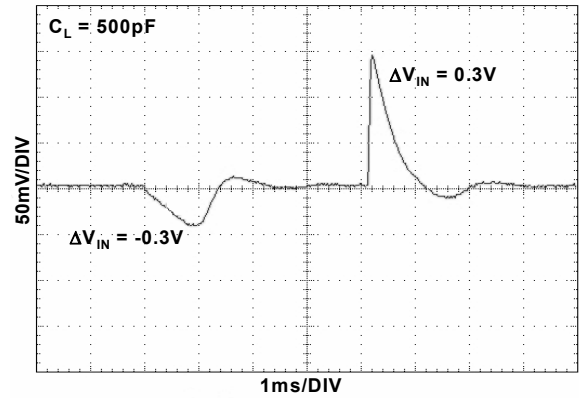

FIGURE 19. LINE TRANSIENT RESPONSE, WITH CAPACITIVE LOAD

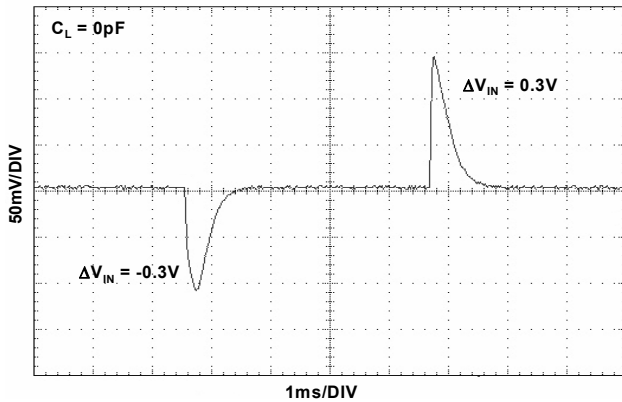

FIGURE 20. LINE TRANSIENT RESPONSE

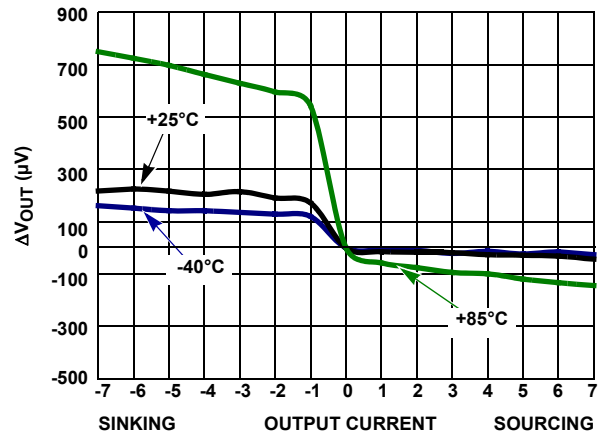

FIGURE 21. LOAD REGULATION OVER-TEMPERATURE

## Typical Performance Characteristics Curves

$V_{OUT} = 1.5V$ ,  $V_{IN} = 3.0V$ ,  $I_{OUT} = 0mA$ ,  $T_A = +25^\circ C$

unless otherwise specified. (Continued)

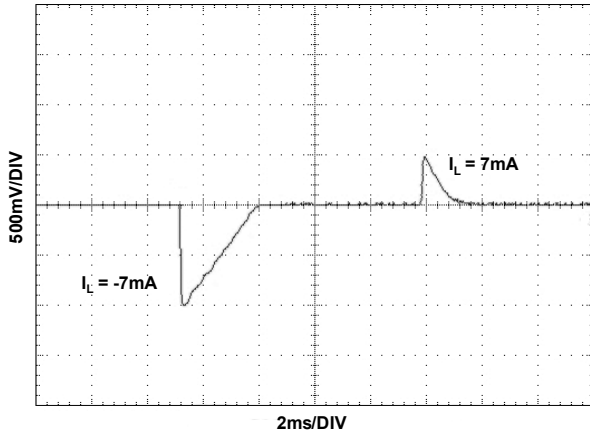

FIGURE 22. LOAD TRANSIENT RESPONSE

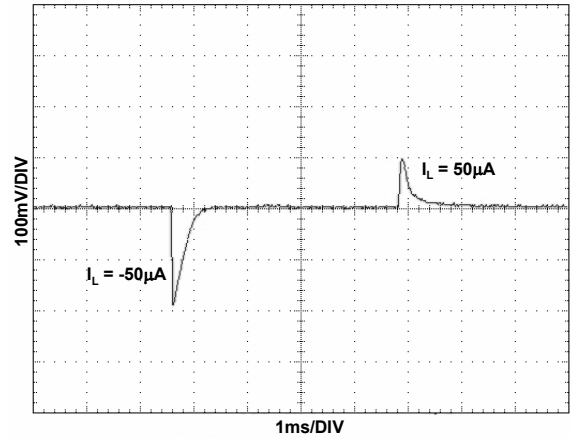

FIGURE 23. LOAD TRANSIENT RESPONSE

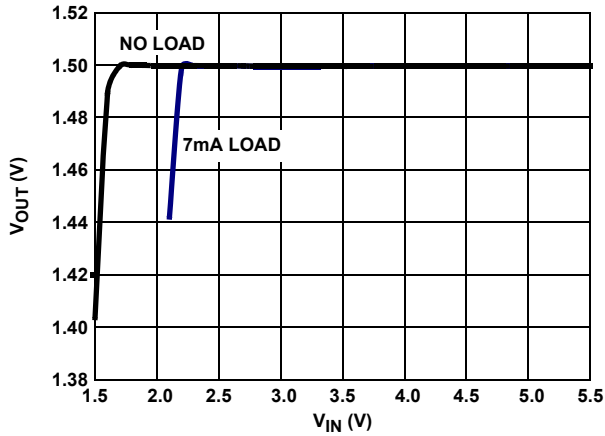

FIGURE 24. DROPOUT

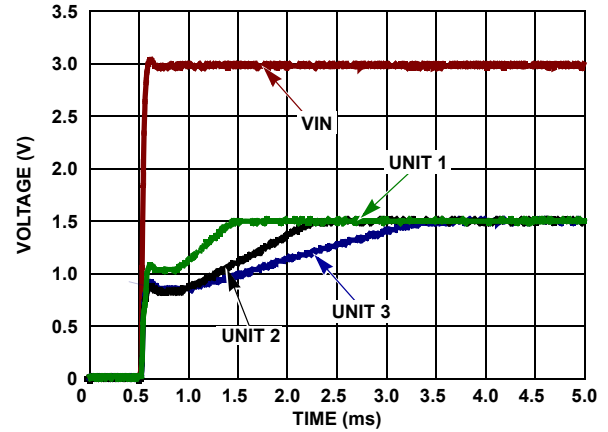

FIGURE 25. TURN-ON TIME

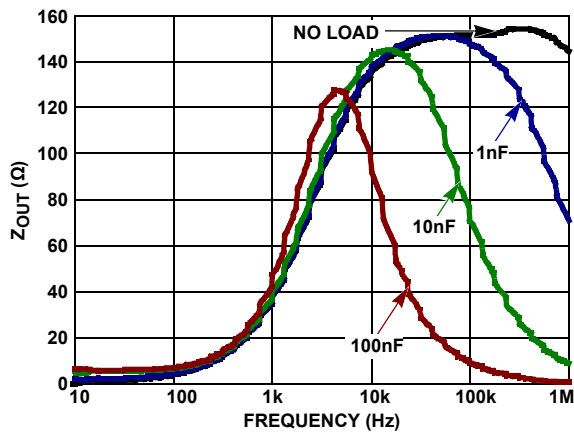

FIGURE 26.  $Z_{OUT}$  vs FREQUENCY

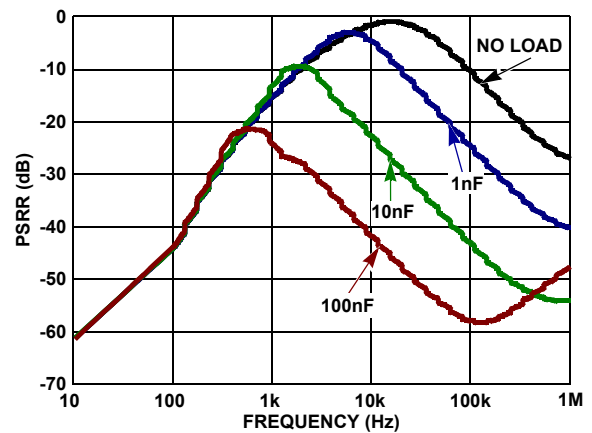

FIGURE 27. PSRR vs FREQUENCY

## Typical Performance Characteristics Curves $T_A = +25^\circ\text{C}$ unless otherwise specified.

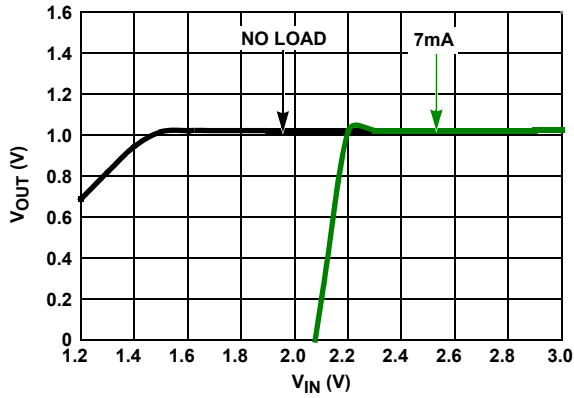

FIGURE 28. DROPOUT, ISL21080-10

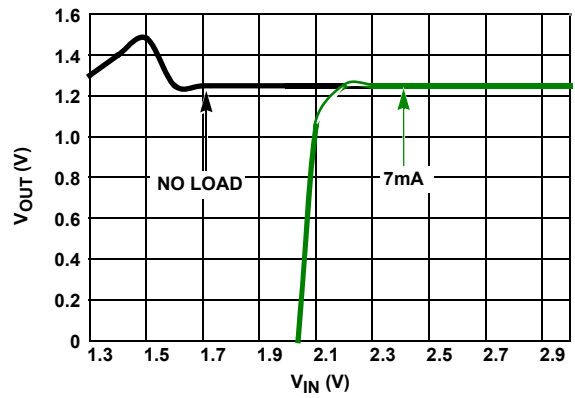

FIGURE 29. DROPOUT, ISL21080-12

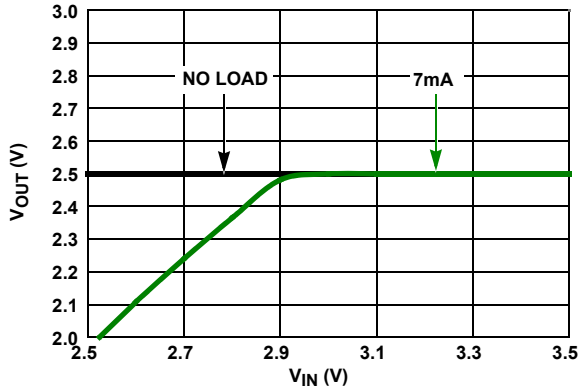

FIGURE 30. DROPOUT, ISL21080-25

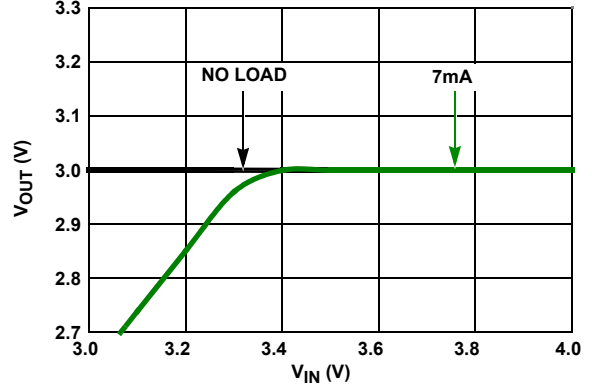

FIGURE 31. DROPOUT, ISL21080-30

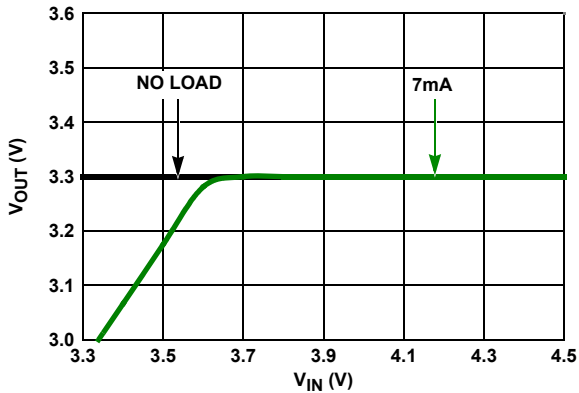

FIGURE 32. DROPOUT, ISL21080-33

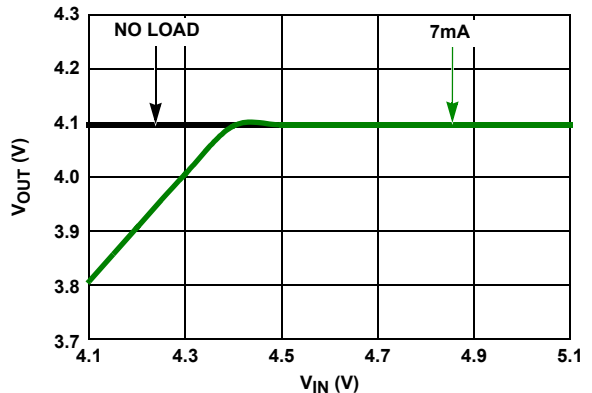

FIGURE 33. DROPOUT, ISL21080-41

## Typical Performance Characteristics Curves $T_A = +25^\circ\text{C}$ unless otherwise specified. (Continued)

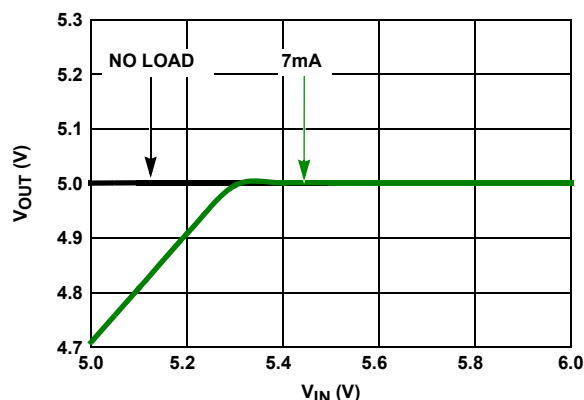

FIGURE 34. DROPOUT, ISL21080-50

## High Current Application

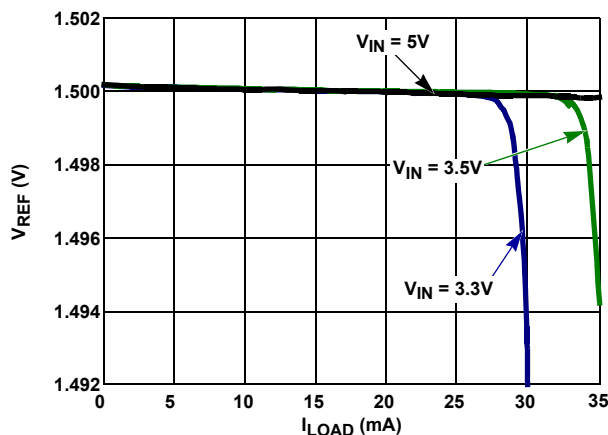

FIGURE 35. DIFFERENT  $V_{IN}$  AT ROOM TEMPERATURE

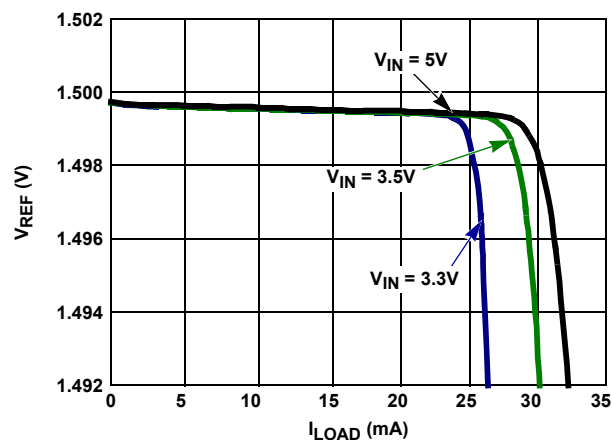

FIGURE 36. DIFFERENT  $V_{IN}$  AT HIGH TEMPERATURE ( $+85^\circ\text{C}$ )

## Applications Information

### FGA Technology

The ISL21080 series of voltage references use the floating gate technology to create references with very low drift and supply current. Essentially, the charge stored on a floating gate cell is set precisely in manufacturing. The reference voltage output itself is a buffered version of the floating gate voltage. The resulting reference device has excellent characteristics which are unique in the industry: very low temperature drift, high initial accuracy, and almost zero supply current. Also, the reference voltage itself is not limited by voltage bandgaps or zener settings, so a wide range of reference voltages can be programmed (standard voltage settings are provided, but customer-specific voltages are available).

The process used for these reference devices is a floating gate CMOS process, and the amplifier circuitry uses CMOS transistors for amplifier and output transistor circuitry. While providing excellent accuracy, there are limitations in output noise level and load regulation due to the MOS device characteristics. These limitations are addressed with circuit techniques discussed in other sections.

### Board Assembly Considerations

FGA references provide high accuracy and low temperature drift but some PC board assembly precautions are necessary. Normal Output voltage shifts of  $100\mu\text{V}$  to  $1\text{mV}$  can be expected with Pb-free reflow profiles or wave solder on multi-layer FR4 PC boards. Precautions should be taken to avoid excessive heat or extended exposure to high reflow or wave solder temperatures, this may reduce device initial accuracy.

Post-assembly x-ray inspection may also lead to permanent changes in device output voltage and should be minimized or avoided. If x-ray inspection is required, it is advisable to monitor the reference output voltage to verify excessive shift has not occurred. If large amounts of shift are observed, it is best to add an X-ray shield consisting of thin zinc ( $300\mu\text{m}$ ) sheeting to allow clear imaging, yet block x-ray energy that affects the FGA reference.

### Special Applications Considerations

In addition to post-assembly examination, there are also other X-ray sources that may affect the FGA reference long term accuracy. Airport screening machines contain X-rays and will have a cumulative effect on the voltage reference output accuracy. Carry-on luggage screening uses low level X-rays and is

not a major source of output voltage shift, however, if a product is expected to pass through that type of screening over 100 times, it may need to consider shielding with copper or aluminum. Checked luggage X-rays are higher intensity and can cause output voltage shift in much fewer passes, thus devices expected to go through those machines should definitely consider shielding. Note that just two layers of 1/2 ounce copper planes will reduce the received dose by over 90%. The leadframe for the device which is on the bottom also provides similar shielding.

If a device is expected to pass through luggage X-ray machines numerous times, it is advised to mount a 2-layer (minimum) PC board on the top, and along with a ground plane underneath will effectively shield it from 50 to 100 passes through the machine. Since these machines vary in X-ray dose delivered, it is difficult to produce an accurate maximum pass recommendation.

## Nanopower Operation

Reference devices achieve their highest accuracy when powered up continuously, and after initial stabilization has taken place. This drift can be eliminated by leaving the power on continuously.

The ISL21080 is the first high precision voltage reference with ultra low power consumption that makes it possible to leave power on continuously in battery operated circuits. The ISL21080 consumes extremely low supply current due to the proprietary FGA technology. Supply current at room temperature is typically 350nA, which is 1 to 2 orders of magnitude lower than competitive devices. Application circuits using battery power will benefit greatly from having an accurate, stable reference, which essentially presents no load to the battery.

In particular, battery powered data converter circuits that would normally require the entire circuit to be disabled when not in use can remain powered up between conversions as shown in Figure 37. Data acquisition circuits providing 12 bits to 24 bits of accuracy can operate with the reference device continuously biased with no power penalty, providing the highest accuracy and lowest possible long term drift.

Other reference devices consuming higher supply currents will need to be disabled in between conversions to conserve battery capacity. Absolute accuracy will suffer as the device is biased and requires time to settle to its final value, or, may not actually settle to a final value as power on time may be short. Table 1 shows an example of battery life in years for ISL21080 in various power on condition with 1.5µA maximum current consumption.

**TABLE 1. EXAMPLE OF BATTERY LIFE IN YEARS FOR ISL21080 IN VARIOUS POWER ON CONDITIONS WITH 1.5µA MAX CURRENT**

BATTERY RATING (mAH)	CONTINUOUS	50% DUTY CYCLE	10% DUTY CYCLE
40	3	6	30*
225	16.3*	32.6*	163*

NOTE: \*Typical Li-ion battery has a shelf life of up to 10 years.

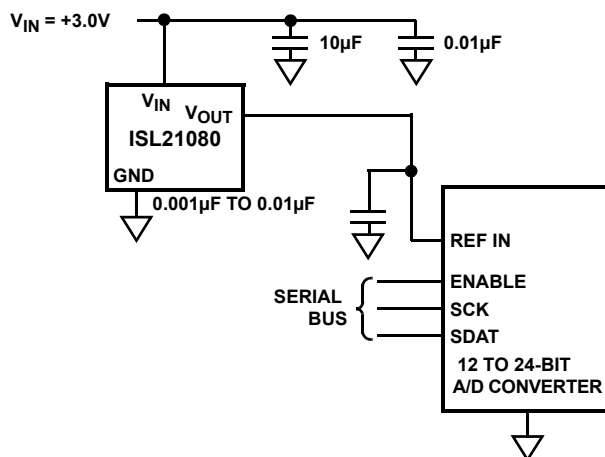

FIGURE 37. REFERENCE INPUT FOR ADC CONVERTER

## ISL21080 Used as a Low Cost Precision Current Source

Using an N-JET and a Nanopower voltage reference, ISL21080, a precision, low cost, high impedance current source can be created. The precision of the current source is largely dependent on the tempco and accuracy of the reference. The current setting resistor contributes less than 20% of the error.

## Board Mounting Considerations

For applications requiring the highest accuracy, board mounting location should be reviewed. Placing the device in areas subject to slight twisting can cause degradation of the accuracy of the reference voltage due to die stresses. It is normally best to place the device near the edge of a board, or the shortest side, as the axis of bending is most limited at that location. Obviously, mounting the device on flexprint or extremely thin PC material will likewise cause loss of reference accuracy.

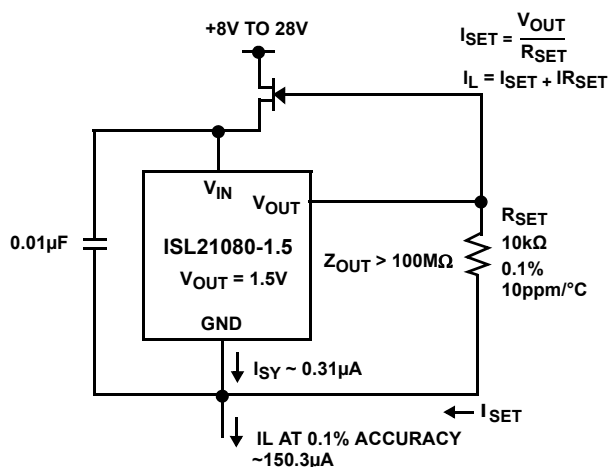

FIGURE 38. ISL21080 USED AS A LOW COST PRECISION CURRENT SOURCE

## Noise Performance and Reduction

The output noise voltage in a 0.1Hz to 10Hz bandwidth is typically  $30\mu\text{V}_{\text{p-p}}$ . This is shown in the plot in the “Typical Performance Characteristics Curves” which begin on page 10. The noise measurement is made with a bandpass filter made of a 1-pole high-pass filter with a corner frequency at 0.1Hz and a 2-pole low-pass filter with a corner frequency at 12.6Hz to create a filter with a 9.9Hz bandwidth. Noise in the 10kHz to 1MHz bandwidth is approximately  $400\mu\text{V}_{\text{p-p}}$  with no capacitance on the output, as shown in Figure 39. These noise measurements are made with a 2 decade bandpass filter made of a 1-pole high-pass filter with a corner frequency at 1/10 of the center frequency and 1-pole low-pass filter with a corner frequency at 10 times the center frequency. Figure 39 also shows the noise in the 10kHz to 1MHz band can be reduced to about  $50\mu\text{V}_{\text{p-p}}$  using a  $0.001\mu\text{F}$  capacitor on the output. Noise in the 1kHz to 100kHz band can be further reduced using a  $0.1\mu\text{F}$  capacitor on the output, but noise in the 1Hz to 100Hz band increases due to instability of the very low power amplifier with a  $0.1\mu\text{F}$  capacitance load. For load capacitances above  $0.001\mu\text{F}$ , the noise reduction network shown in Figure 40 is recommended. This network reduces noise significantly over the full bandwidth. As shown in Figure 39, noise is reduced to less than  $40\mu\text{V}_{\text{p-p}}$  from 1Hz to 1MHz using this network with a  $0.01\mu\text{F}$  capacitor and a  $2\text{k}\Omega$  resistor in series with a  $10\mu\text{F}$  capacitor.

## Turn-On Time

The ISL21080 devices have ultra-low supply current and thus, the time to bias-up internal circuitry to final values will be longer than with higher power references. Normal turn-on time is typically 7ms. This is shown in Figure 38. Since devices can vary in supply current down to  $>300\text{nA}$ , turn-on time can last up to about 12ms. Care should be taken in system design to include this delay before measurements or conversions are started.

## Temperature Coefficient

The limits stated for temperature coefficient (tempco) are governed by the method of measurement. The overwhelming standard for specifying the temperature drift of a reference, is to measure the reference voltage at two temperatures, take the total variation,  $(V_{\text{HIGH}} - V_{\text{LOW}})$ , and divide by the temperature extremes of measurement  $(T_{\text{HIGH}} - T_{\text{LOW}})$ . The result is divided by the nominal reference voltage (at  $T = +25^\circ\text{C}$ ) and multiplied by  $10^6$  to yield ppm/ $^\circ\text{C}$ . This is the “Box” method for specifying temperature coefficient.

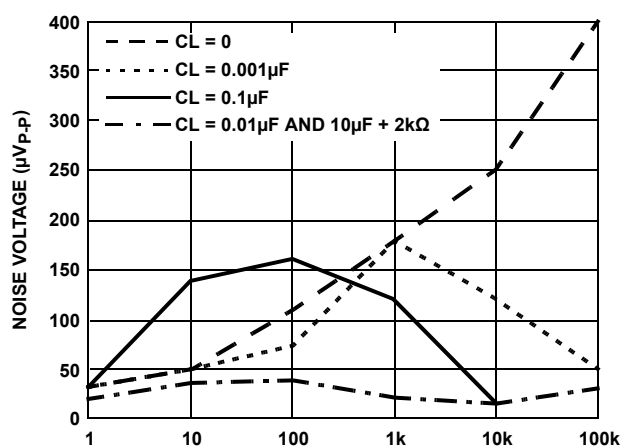

FIGURE 39. NOISE REDUCTION

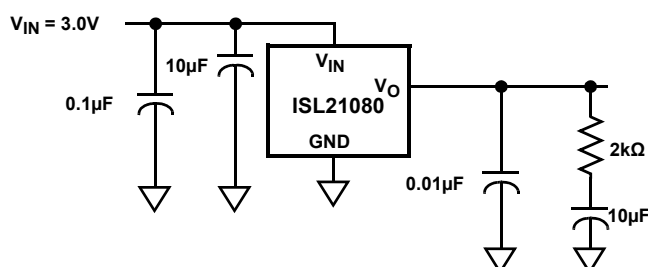

FIGURE 40. NOISE REDUCTION NETWORK

For additional products, see [www.intersil.com/en/products.html](http://www.intersil.com/en/products.html)

Intersil products are manufactured, assembled and tested utilizing ISO9001 quality systems as noted in the quality certifications found at [www.intersil.com/en/support/qualandreliability.html](http://www.intersil.com/en/support/qualandreliability.html)

Intersil products are sold by description only. Intersil Corporation reserves the right to make changes in circuit design, software and/or specifications at any time without notice. Accordingly, the reader is cautioned to verify that data sheets are current before placing orders. Information furnished by Intersil is believed to be accurate and reliable. However, no responsibility is assumed by Intersil or its subsidiaries for its use; nor for any infringements of patents or other rights of third parties which may result from its use. No license is granted by implication or otherwise under any patent or patent rights of Intersil or its subsidiaries.

For information regarding Intersil Corporation and its products, see [www.intersil.com](http://www.intersil.com)



## Typical Application Circuits

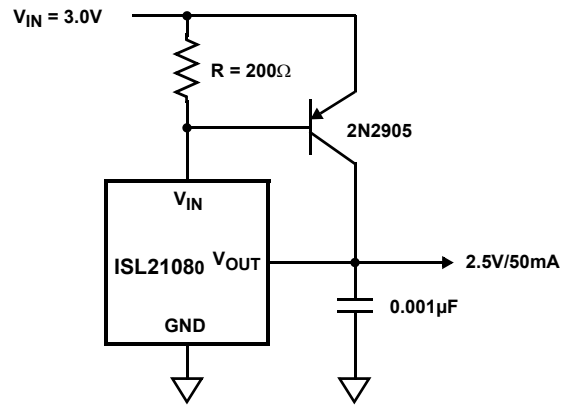

FIGURE 41. PRECISION 2.5V 50mA REFERENCE

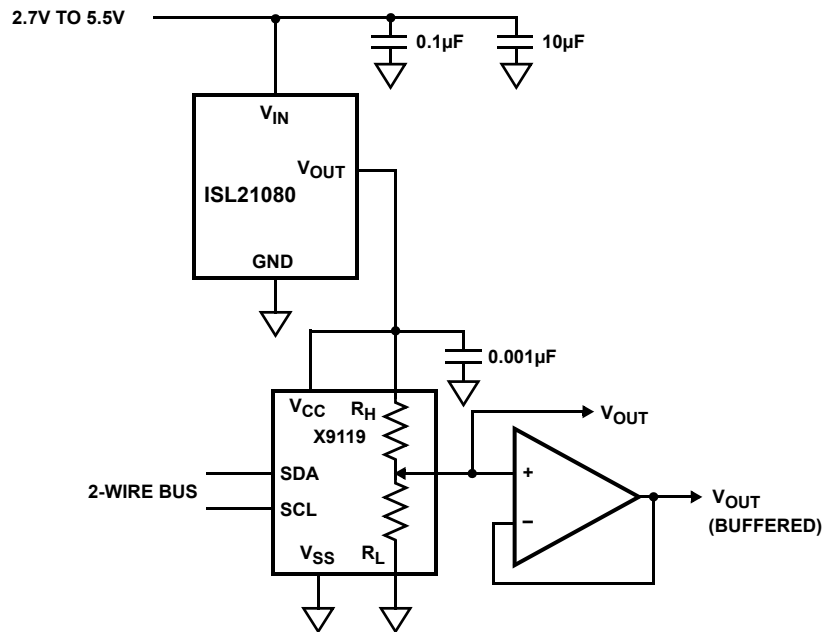

FIGURE 42. 2.5V FULL SCALE LOW-DRIFT 10-BIT ADJUSTABLE VOLTAGE SOURCE

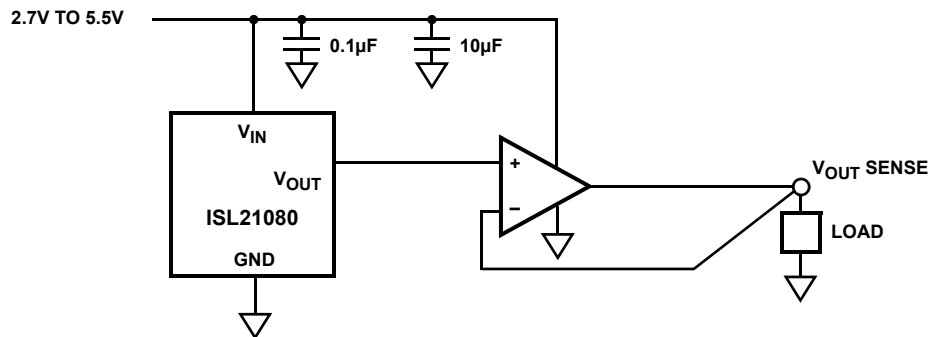

FIGURE 43. KELVIN SENSED LOAD

## Revision History

The revision history provided is for informational purposes only and is believed to be accurate, but not warranted. Please go to web to make sure you have the latest Rev.

DATE	REVISION	CHANGE
June 23, 2014	FN6934.5	<p>Converted to New Template</p> <p>Updated POD with following changes:</p> <p>In Detail A, changed lead width dimension from 0.13+/-0.05 to 0.085-0.19</p> <p>Changed dimension of foot of lead from 0.31+/-0.10 to 0.38+/-0.10</p> <p>In Land Pattern, added 0.4 Rad Typ dimension</p> <p>In Side View, changed height of package from 0.91+/-0.03 to 0.95+/-0.07</p>
May, 12, 2010	FN6934.4	Changed Theta JA in the "Thermal Information" on page 3 from 170 to 275. Added Theta JC and applicable note.
April 29, 2010	FN6934.3	Incorrect Thermal information, needs to be re-evaluated and added at a later date when the final data is available. Removed Theta JC and applicable note from "Thermal Information" on page 3.
April 14, 2010		Corrected y axis label on Figure 9 from "V <sub>OUT</sub> (V)" to "V <sub>OUT</sub> (μV)"
April 6, 2010		<p>Source/sink for 0.9V option changed from 7mA to 10mA</p> <p>Line regulation condition for 0.9V changed from 2.7V to 2V</p> <p>Line regulation typical for 0.9V option changed from 10 to 30μV/V</p> <p>ΔT<sub>A</sub> in Thermal Hysteresis conditions of 0.9V option changed from 165°C to 125°C</p> <p>Moved "Board Assembly Considerations" and "Special Applications Considerations" to page 14. Deleted "Handling and Board Mounting" section since "Board Assembly Considerations" on page 14 contains same discussion.</p> <p>Added "Special Note: Post-assembly x-ray inspection may lead to permanent changes in device output voltage and should be minimized or avoided." to "ISL21080" on page 1</p> <p>Figures 2 and 3 revised to show line regulation and lin down to 2V.</p> <p>Figures 4 and 5 revised to show Vin down to 2V.</p> <p>Added "Initial accuracy can change 10mV or more under extreme radiation." to Note 9 on page 3.</p>
April 1, 2010		<ol style="list-style-type: none"> <li>1. page 3: Change Vin Min from 2.7 to 2.0</li> <li>2. page 3: Change lin Typ from 0.31 to 0.35</li> <li>3. page 3: Change Line Reg Typ from 80 to 10</li> <li>4. page 3: Change Load Reg Condition from 7mA to 10mA and -7mA to -10mA</li> <li>5. page 3: Change Load Reg Typ for Source from 25 to 6 and Sink from 50 to 23.</li> <li>6. page 3: Change Isc Typ from 50 to 30</li> <li>7. page 3: Change tR from 4 to 1</li> <li>8. Change Ripple Rejection typ for all options from -30 to -40</li> <li>9. page 3: Change eN typ from 30 to 40V</li> <li>10. page 3: Change VN typ from 50 to 10V</li> <li>11. page 3: Change Noise Density typ from 1.1 to 2.2</li> <li>12. page 3: Change Long Term Stability from 50 to 60</li> <li>13. Added Figure 2 to 13 on page 8 to page 10 for 0.9V curves.</li> <li>14. Added Figure 28 to 34 on page 13 to page 14 for other options Dropout curve.</li> <li>15. page 1: Change Input Voltage Range for 0.9V option from TBD to 2V to 5.5V</li> <li>16. Added latch up to "Absolute Maximum Ratings" on page 3</li> <li>17. Added Junction Temperature to "Thermal Information" on page 3</li> <li>18. Added JEDEC standards used at the time of testing for "ESD Ratings" on page 3</li> <li>19. HBM in "Absolute Maximum Ratings" on page 3 changed from 5.5kV to 5kV</li> <li>20. Added Theta JC and applicable note.</li> </ol>
March 25, 2010		<p>Throughout- Converted to new format. Changes made as follows:</p> <p>Moved "Pin Configuration" and "Pin Descriptions" to page 2</p> <p>Added "Related Literature" to page 1</p> <p>Added key selling feature graphic Figure 1 to page 1</p> <p>Added "Boldface limits apply..." note to common conditions of Electrical Specifications tables on page 3 through page 8. Bolded applicable specs. Added Note 13 to MIN MAX columns of all Electrical Specifications tables.</p> <p>Added "Environmental Operating Conditions" to page 3 and added Note 5</p> <p>Added "The process used for these reference devices is a floating gate CMOS process, and the amplifier circuitry uses CMOS transistors for amplifier and output transistor circuitry. While providing excellent accuracy, there are limitations in output noise level and load regulation due to the MOS device characteristics. These limitations are addressed with circuit techniques discussed in other sections." on page 14</p>

# ISL21080

## Revision History

The revision history provided is for informational purposes only and is believed to be accurate, but not warranted. Please go to web to make sure you have the latest Rev.

DATE	REVISION	CHANGE
Oct 14,2009	FN6934.2	<ol style="list-style-type: none"><li>1. Removed "Coming Soon" on page 1 and 2 for -10, -20, -41, and -50 options.</li><li>2. Page 1. Moved "ISL21080-505.5V to 8.0V" from bullet to sub-bullet.</li><li>3. Update package outline drawing P3.064 to most recent revision. Updates to package were to add land pattern and move dimensions from table onto drawing (no change to package dimensions)</li></ol>
Sep 04, 2009	FN6934.1	<p><b>Converted to new Intersil template.</b> Added Revision History and Products Information. Updated Ordering Information to match Intrepid, numbered all notes and added Moisture Sensitivity Note with links. Moved Pin Descriptions to page 1 to follow pinout</p> <p><b>Changed</b> in Features Section</p> <p><b>From:</b> Reference Output Voltage 1.25V, 1.5V, 2.500V, 3.300V <b>To:</b> Reference Output Voltage 0.900V, 1.024V, 1.250V, 1.500V, 2.048V, 2.500V, 3.000V, 3.300V, 4.096V, 5.000V</p> <p><b>From:</b> Initial Accuracy: 1.5V±0.5% <b>To:</b> Initial Accuracy: ISL21080-09 and -10±0.7% ISL21080-12 ±0.6% ISL21080-15±0.5% ISL21080-20 and -25±0.3% ISL21080-30, -33, -41, and -50±0.2%</p> <p><b>FROM:</b> Input Voltage Range ISL21080-12 (Coming Soon) 2.7V to 5.5V ISL21080-15 2.7V to 5.5V ISL21080-25 (Coming Soon) 2.7V to 5.5V ISL21080-33 (Coming Soon) 3.5V to 5.5V</p> <p><b>TO:</b> Input Voltage Range: ISL21080-09, -10, -12, -15, -20, and -25 2.7V to 5.5V ISL21080-09, -10, and 20 (Coming Soon) ISL21080-30 3.2V to 5.5V ISL21080-33 3.5V to 5.5V ISL21080-41 (Coming Soon) 4.5V to 8.0V</p> <p><b>Added:</b> ISL21080-50 (Coming Soon) 5.5V to 8.0V Output Voltage Noise 30µVP-P (0.1Hz to 10Hz)</p> <p><b>Updated</b> Electrical Spec Tables by Tables with Voltage References 9, 10, 12, 20, 25, 30, 33 and 41.</p> <p><b>Added</b> to Abs Max Ratings: VIN to GND (ISL21080-41 and 50 only) -0.5V to +10V VOUT to GND (10s) (ISL21080-41 and 50 only) -0.5V to +5.1V</p> <p><b>Changed</b> Tja in Thermal information from "202.70" to "170" to match ASYD in Intrepid</p> <p><b>Added Note:</b> Post-assembly x-ray inspection may also lead to permanent changes in device output voltage and should be minimized or avoided. Most inspection equipment will not affect the FGA reference voltage, but if x-ray inspection is required, it is advisable to monitor the reference output voltage to verify excessive shift has not occurred.</p> <p><b>Added</b> Special Applications Considerations Section on page 12.</p>
July 28,2009	FN6934.0	Initial Release.

## About Intersil

Intersil Corporation is a leading provider of innovative power management and precision analog solutions. The company's products address some of the largest markets within the industrial and infrastructure, mobile computing and high-end consumer markets.

For the most updated datasheet, application notes, related documentation and related parts, please see the respective product information page found at [www.intersil.com](http://www.intersil.com).

You may report errors or suggestions for improving this datasheet by visiting [www.intersil.com/ask](http://www.intersil.com/ask).

Reliability reports are also available from our website at [www.intersil.com/support](http://www.intersil.com/support)

## Package Outline Drawing

### P3.064

3 LEAD SMALL OUTLINE TRANSISTOR PLASTIC PACKAGE (SOT23-3)

Rev 3, 3/12

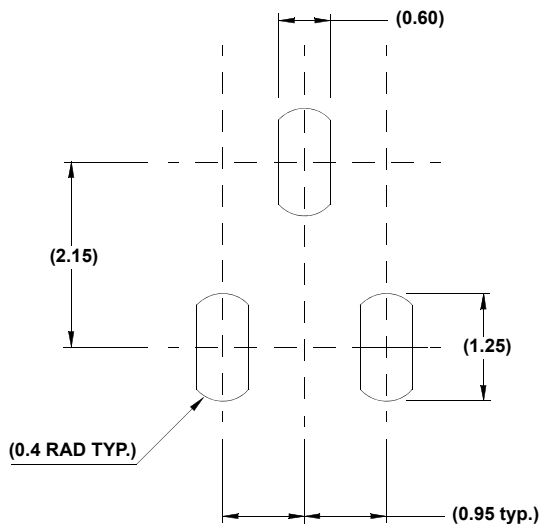
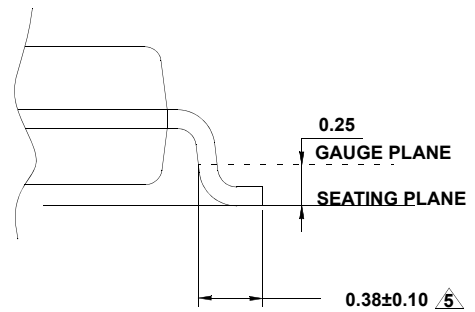
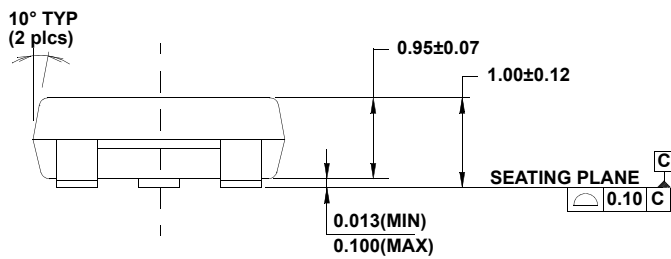
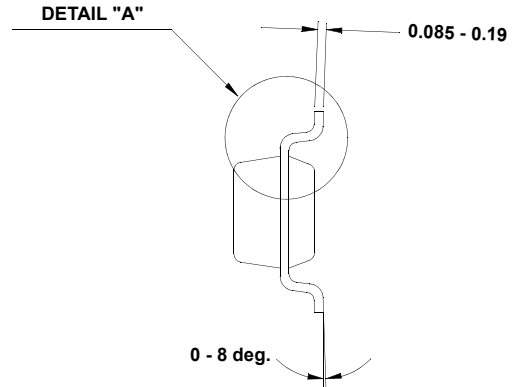
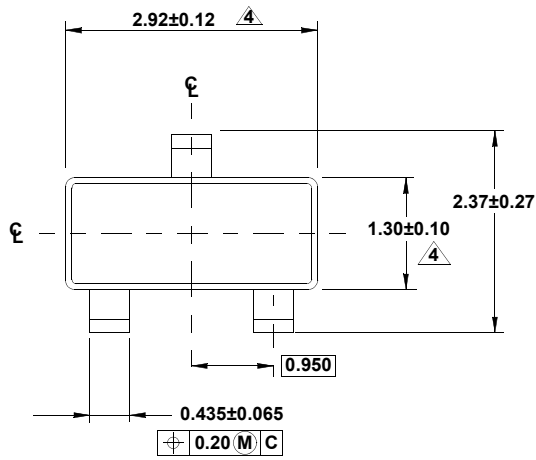

#### NOTES:

1. Dimensions are in millimeters. Dimensions in ( ) for Reference Only.
2. Dimensioning and tolerancing conform to AMSEY14.5m-1994.
3. Reference JEDEC TO-236.
4. Dimension does not include interlead flash or protrusions. Interlead flash or protrusions shall not exceed 0.25mm per side.
5. Footlength is measured at reference to gauge plane.

# Mouser Electronics

Authorized Distributor

Click to View Pricing, Inventory, Delivery & Lifecycle Information:

## Intersil:

[ISL21080CIH315Z-T7A](#) [ISL21080CIH315Z-TK](#) [ISL21080CIH320Z-TK](#) [ISL21080CIH325Z-TK](#) [ISL21080CIH330Z-TK](#)  
[ISL21080CIH333Z-TK](#) [ISL21080CIH341Z-TK](#) [ISL21080CIH350Z-TK](#) [ISL21080DIH309Z-TK](#) [ISL21080DIH310Z-TK](#)  
[ISL21080DIH312Z-TK](#)