

# ±60V Fault Protected, 5V, RS-485/RS-422 Transceivers with ±25V CMR and ESD Protection

## ISL32490E, ISL32492E, ISL32493E, ISL32495E, ISL32496E, ISL32498E

The [ISL32490E](#), [ISL32492E](#), [ISL32493E](#), [ISL32495E](#), [ISL32496E](#), [ISL32498E](#) are fault protected, 5V powered, differential transceivers that exceed the RS-485 and RS-422 standards for balanced communication. The RS-485 transceiver pins (driver outputs and receiver inputs) are fault protected up to ±60V and are protected against ±16.5kV ESD strikes without latch-up. Additionally, the extended common mode range allows these transceivers to operate in environments with common mode voltages up to ±25V (>2x the RS-485 requirement), making this fault protected RS-485 family one of the most robust on the market.

Transmitters (Tx) deliver an exceptional 2.5V (typical) differential output voltage into the RS-485 specified 54Ω load. This yields better noise immunity than standard RS-485 ICs or allows up to six 120Ω terminations in star network topologies.

Receiver (Rx) inputs feature a “Full Fail-Safe” design that ensures a logic high Rx output if Rx inputs are floating, shorted, or on a terminated but undriven (idle) bus. Rx outputs have high drive levels; typically, 15mA at  $V_{OL} = 1V$  (for opto-coupled, isolated applications).

Half duplex (Rx inputs and Tx outputs multiplexed together) and full duplex pinouts are available. See [Table 1 on page 2](#) for key features and configurations by device number.

For fault protected or wide common mode range RS-485 transceivers with cable invert (polarity reversal) pins, please see the [ISL32483E](#) data sheet.

### Features

- Fault protected RS-485 bus pins . . . . . up to ±60V
- Extended common mode range . . . . . ±25V more than twice the range required for RS-485
- ±16.5kV HBM ESD protection on RS-485 bus pins
- 1/4 unit load for up to 128 devices on the bus
- High transient overvoltage tolerance . . . . . ±80V
- Full fail-safe (open, short, terminated) RS-485 receivers
- High Rx  $I_{OL}$  for opto-couplers in isolated designs
- Hot plug circuitry; Tx and Rx outputs remain three-state during power-up/power-down
- Choice of RS-485 data rates . . . . . 250kbps to 15Mbps
- Low quiescent supply current . . . . . 2.3mA
- Ultra low shutdown supply current . . . . . 10μA

### Applications

- Utility meters/automated meter reading systems
- High node count RS-485 systems
- PROFIBUS™ and RS-485 based field bus networks, and factory automation
- Security camera networks
- Building lighting and environmental control systems
- Industrial/process control networks

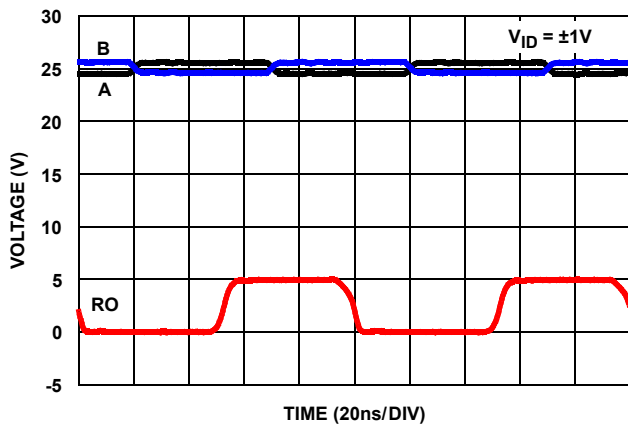

FIGURE 1. EXCEPTIONAL Rx OPERATES AT >15Mbps EVEN WITH A ±25V COMMON MODE VOLTAGE

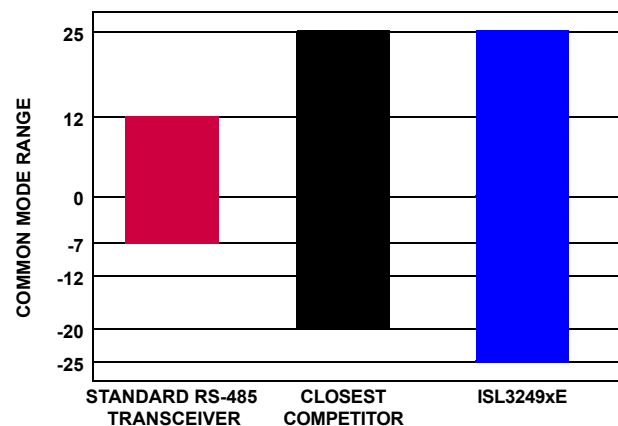

FIGURE 2. ISL3249xE DELIVERS SUPERIOR COMMON MODE RANGE vs STANDARD RS-485 DEVICES

# ISL32490E, ISL32492E, ISL32493E, ISL32495E, ISL32496E, ISL32498E

TABLE 1. SUMMARY OF FEATURES

PART NUMBER	HALF/FULL DUPLEX	DATA RATE (Mbps)	SLEW-RATE LIMITED?	EN PINS?	HOT PLUG?	QUIESCENT I <sub>CC</sub> (mA)	LOW POWER SHDN?	PIN COUNT
ISL32490E	Full	0.25	Yes	Yes	Yes	2.3	Yes	10, 14
ISL32492E	Half	0.25	Yes	Yes	Yes	2.3	Yes	8
ISL32493E	Full	1	Yes	Yes	Yes	2.3	Yes	10, 14
ISL32495E	Half	1	Yes	Yes	Yes	2.3	Yes	8
ISL32496E	Full	15	No	Yes	Yes	2.3	Yes	10, 14
ISL32498E	Half	15	No	Yes	Yes	2.3	Yes	8

## Ordering Information

PART NUMBER (Notes 1, 2, 3)	PART MARKING	TEMP. RANGE (°C)	PACKAGE (RoHS Compliant)	PKG. DWG. #
ISL32490EIBZ	ISL32490 EIBZ	-40 to +85	14 Ld SOIC	M14.15
ISL32490EIUZ	2490E	-40 to +85	10 Ld MSOP	M10.118
ISL32492EIBZ	32492 EIBZ	-40 to +85	8 Ld SOIC	M8.15
ISL32492EIUZ	2492E	-40 to +85	8 Ld MSOP	M8.118
ISL32493EIBZ	ISL32493 EIBZ	-40 to +85	14 Ld SOIC	M14.15
ISL32493EIUZ	2493E	-40 to +85	10 Ld MSOP	M10.118
ISL32495EIBZ	32495 EIBZ	-40 to +85	8 Ld SOIC	M8.15
ISL32495EIUZ	2495E	-40 to +85	8 Ld MSOP	M8.118
ISL32496EIBZ	ISL32496 EIBZ	-40 to +85	14 Ld SOIC	M14.15
ISL32496EIUZ	2496E	-40 to +85	10 Ld MSOP	M10.118
ISL32498EIBZ	32498 EIBZ	-40 to +85	8 Ld SOIC	M8.15
ISL32498EIUZ	2498E	-40 to +85	8 Ld MSOP	M8.118

NOTES:

1. Add "-T\*" suffix for tape and reel. Please refer to [TB347](#) for details on reel specifications.
2. These Intersil Pb-free plastic packaged products employ special Pb-free material sets, molding compounds/die attach materials, and 100% matte tin plate plus anneal (e3 termination finish, which is RoHS compliant and compatible with both SnPb and Pb-free soldering operations). Intersil Pb-free products are MSL classified at Pb-free peak reflow temperatures that meet or exceed the Pb-free requirements of IPC/JEDEC J STD-020.
3. For Moisture Sensitivity Level (MSL), please see device information pages for [ISL32490E](#), [ISL32492E](#), [ISL32493E](#), [ISL32495E](#), [ISL32496E](#), [ISL32498E](#). For more information on MSL please see techbrief [TB363](#).

## Pin Configurations

ISL32492E, ISL32495E, ISL32498E  
(8 LD MSOP, 8 LD SOIC)  
TOP VIEW

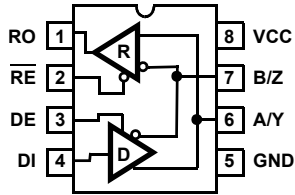

ISL32490E, ISL32493E, ISL32496E  
(10 LD MSOP)  
TOP VIEW

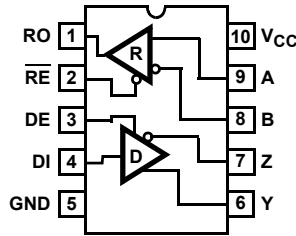

ISL32490E, ISL32493E, ISL32496E  
(14 LD SOIC)  
TOP VIEW

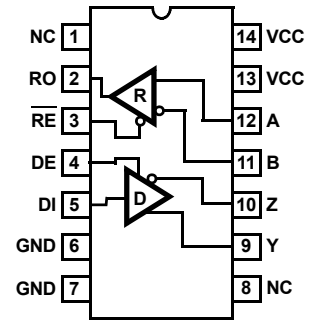

**NOTE:** Evaluate creepage and clearance requirements at your maximum fault voltage before using small pitch packages (e.g., MSOP).

## Truth Tables

TRANSMITTING				
INPUTS			OUTPUTS	
$\overline{RE}$	DE	DI	Z	Y
X	1	1	0	1
X	1	0	1	0
0	0	X	High-Z	High-Z
1	0	X	High-Z (see Note)	High-Z (see Note)

**NOTE:** Low Power Shutdown Mode (see [Note 11 on page 9](#)).

RECEIVING				
INPUTS				OUTPUT
$\overline{RE}$	DE Half Duplex	DE Full Duplex	A-B	RO
0	0	X	$\geq -0.01V$	1
0	0	X	$\leq -0.2V$	0
0	0	X	Inputs Open/Shorted	1
1	0	0	X	High-Z (see Note)
1	1	1	X	High-Z

**NOTE:** Low Power Shutdown Mode (see [Note 11 on page 9](#)).

## Pin Descriptions

PIN NAME	8 LD PIN #	10 LD PIN #	14 LD PIN #	FUNCTION
RO	1	1	2	Receiver output. If $A-B \geq -10mV$ , RO is high; if $A-B \leq -200mV$ , RO is low; RO = High if A and B are unconnected (floating), shorted together, or connected to an undriven, terminated bus.
$\overline{RE}$	2	2	3	Receiver output enable. RO is enabled when $\overline{RE}$ is low; RO is high impedance when $\overline{RE}$ is high. Internally pulled low.
DE	3	3	4	Driver output enable. The driver outputs, Y and Z, are enabled by bringing DE high. They are high impedance when DE is low. Internally pulled high.
DI	4	4	5	Driver input. A low on DI forces output Y low and output Z high. Similarly, a high on DI forces output Y high and output Z low.
GND	5	5	6, 7	Ground connection.
A/Y	6	-	-	$\pm 60V$ Fault and $\pm 16.5kV$ HBM ESD Protected RS-485/RS-422 level, non-inverting receiver input and non-inverting driver output. Pin is an input if DE = 0; pin is an output if DE = 1.
B/Z	7	-	-	$\pm 60V$ Fault and $\pm 16.5kV$ HBM ESD Protected RS-485/RS-422 level, inverting receiver input and inverting driver output. Pin is an input if DE = 0; pin is an output if DE = 1.
A	-	9	12	$\pm 60V$ Fault and $\pm 15kV$ HBM ESD Protected RS-485/RS-422 level, non-inverting receiver input.
B	-	8	11	$\pm 60V$ Fault and $\pm 15kV$ HBM ESD Protected RS-485/RS-422 level, inverting receiver input.

## Pin Descriptions (Continued)

PIN NAME	8 LD PIN #	10 LD PIN #	14 LD PIN #	FUNCTION
Y	-	6	9	$\pm 60\text{V}$ Fault and $\pm 15\text{kV}$ HBM ESD Protected RS-485/RS-422 level, non-inverting driver output.
Z	-	7	10	$\pm 60\text{V}$ Fault and $\pm 15\text{kV}$ HBM ESD Protected RS-485/RS-422 level, inverting driver output.
VCC	8	10	13, 14	System power supply input (4.5V to 5.5V).
NC	-	-	1, 8	No internal connection.

## Typical Operating Circuits

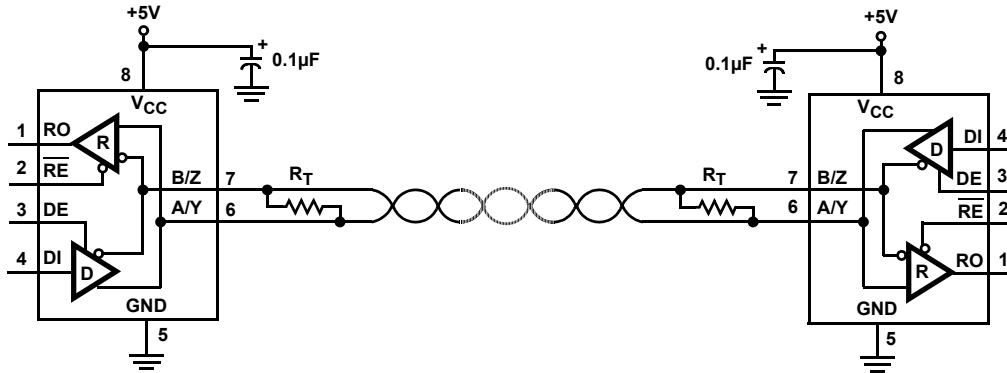

FIGURE 3. ISL32492E, ISL32495E, ISL32498E HALF DUPLEX EXAMPLE

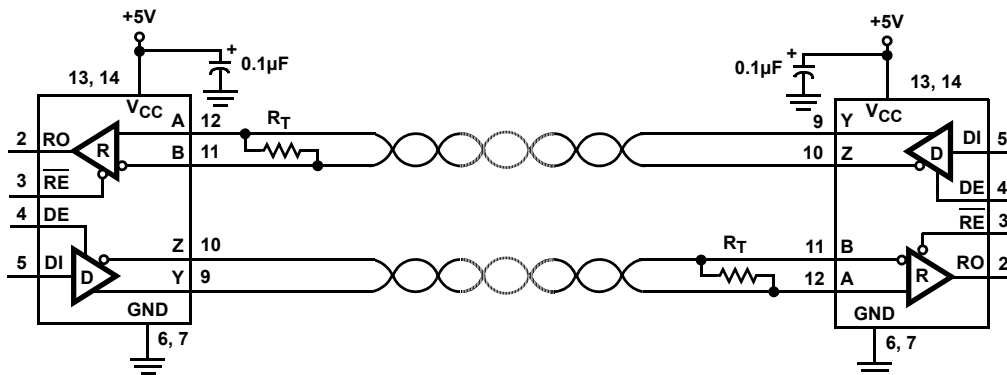

FIGURE 4. ISL32490E, ISL32493E, ISL32496E FULL DUPLEX EXAMPLE (SOIC PIN NUMBERS SHOWN)

### Absolute Maximum Ratings

V <sub>CC</sub> to Ground	7V
Input Voltages	
DI, DE, $\overline{RE}$	-0.3V to (V <sub>CC</sub> + 0.3V)
Input/Output Voltages	
A/Y, B/Z, A, B, Y, Z	±60V
A/Y, B/Z, A, B, Y, Z (Transient Pulse Through 100Ω, (Note 15))	±80V
RO	-0.3V to (V <sub>CC</sub> + 0.3V)
Short Circuit Duration	
Y, Z	Indefinite
ESD Rating	see "ESD PERFORMANCE" on page 6
Latch-up (Tested per JESD78, Level 2, Class A)	+125°C

### Thermal Information

Thermal Resistance (Typical)	$\theta_{JA}$ (°C/W)	$\theta_{JC}$ (°C/W)
8 Ld MSOP Package (Notes 4, 5)	140	40
8 Ld SOIC Package (Notes 4, 5)	108	47
10 Ld MSOP Package (Notes 4, 5)	135	50
14 Ld SOIC Package (Notes 4, 5)	88	39
Maximum Junction Temperature (Plastic Package)	+150°C	
Maximum Storage Temperature Range	-65°C to +150°C	
Pb-free Reflow Profile	see TB493	

### Recommended Operating Conditions

Supply Voltage (V <sub>CC</sub> )	5V
Temperature Range	-40°C to +85°C
Bus Pin Common Mode Voltage Range	-25V to +25V

CAUTION: Do not operate at or near the maximum ratings listed for extended periods of time. Exposure to such conditions may adversely impact product reliability and result in failures not covered by warranty.

NOTES:

- $\theta_{JA}$  is measured with the component mounted on a high effective thermal conductivity test board in free air. See Tech Brief TB379 for details.
- For  $\theta_{JC}$ , the "case temp" location is taken at the package top center.

**Electrical Specifications** V<sub>CC</sub> = 4.5V to 5.5V; Unless Otherwise Specified. Typicals are at V<sub>CC</sub> = 5V, T<sub>A</sub> = +25°C (Note 6). **Boldface limits apply across the operating temperature range, -40°C to +85°C.**

SYMBOL	PARAMETER	TEST CONDITIONS	TEMP (°C)	MIN (Note 14)	TYP	MAX (Note 14)	UNITS
<b>DC CHARACTERISTICS</b>							
V <sub>OD1</sub>	Driver Differential V <sub>OUT</sub> (No load)		Full	-	-	V <sub>CC</sub>	V
V <sub>OD2</sub>	Driver Differential V <sub>OUT</sub> (Loaded, Figure 5A)	R <sub>L</sub> = 100Ω (RS-422)	Full	<b>2.4</b>	3.2	-	V
		R <sub>L</sub> = 54Ω (RS-485)	Full	<b>1.5</b>	2.5	V <sub>CC</sub>	V
		R <sub>L</sub> = 54Ω (PROFIBUS, V <sub>CC</sub> ≥ 5V)	Full	<b>2.0</b>	2.5		
		R <sub>L</sub> = 21Ω (Six 120Ω terminations for Star Configurations, V <sub>CC</sub> ≥ 4.75V)	Full	<b>0.8</b>	1.3	-	V
ΔV <sub>OD</sub>	Change in Magnitude of Driver Differential V <sub>OUT</sub> for Complementary Output States	R <sub>L</sub> = 54Ω or 100Ω (Figure 5A)	Full	-	-	<b>0.2</b>	V
V <sub>OD3</sub>	Driver Differential V <sub>OUT</sub> with Common Mode Load (Figure 5B)	R <sub>L</sub> = 60Ω, -7V ≤ V <sub>CM</sub> ≤ 12V	Full	<b>1.5</b>	2.1	V <sub>CC</sub>	V
		R <sub>L</sub> = 60Ω, -25V ≤ V <sub>CM</sub> ≤ 25V (V <sub>CC</sub> ≥ 4.75V)	Full	<b>1.7</b>	2.3		
		R <sub>L</sub> = 21Ω, -15V ≤ V <sub>CM</sub> ≤ 15V (V <sub>CC</sub> ≥ 4.75V)	Full	<b>0.8</b>	1.1	-	V
V <sub>OC</sub>	Driver Common-Mode V <sub>OUT</sub> (Figure 5)	R <sub>L</sub> = 54Ω or 100Ω	Full	<b>-1</b>	-	<b>3</b>	V
		R <sub>L</sub> = 60Ω or 100Ω, -20V ≤ V <sub>CM</sub> ≤ 20V	Full	<b>-2.5</b>	-	<b>5</b>	V
ΔV <sub>OC</sub>	Change in Magnitude of Driver Common Mode V <sub>OUT</sub> for Complementary Output States	R <sub>L</sub> = 54Ω or 100Ω (Figure 5A)	Full	-	-	<b>0.2</b>	V
I <sub>OSD</sub>	Driver Short-circuit Current	DE = V <sub>CC</sub> , -25V ≤ V <sub>O</sub> ≤ 25V (Note 8)	Full	<b>-250</b>	-	<b>250</b>	mA
I <sub>OSD1</sub>		At First Fold-back, 22V ≤ V <sub>O</sub> ≤ -22V	Full	<b>-83</b>	-	<b>83</b>	mA
I <sub>OSD2</sub>		At Second Fold-back, 35V ≤ V <sub>O</sub> ≤ -35V	Full	<b>-13</b>	-	<b>13</b>	mA
V <sub>IH</sub>	Logic Input High Voltage	DE, DI, $\overline{RE}$	Full	<b>2.5</b>	-	-	V
V <sub>IL</sub>	Logic Input Low Voltage	DE, DI, $\overline{RE}$	Full	-	-	<b>0.8</b>	V

# ISL32490E, ISL32492E, ISL32493E, ISL32495E, ISL32496E, ISL32498E

**Electrical Specifications**  $V_{CC} = 4.5V$  to  $5.5V$ ; Unless Otherwise Specified. Typicals are at  $V_{CC} = 5V$ ,  $T_A = +25^\circ C$  (Note 6). **Boldface limits apply across the operating temperature range,  $-40^\circ C$  to  $+85^\circ C$ .** (Continued)

SYMBOL	PARAMETER	TEST CONDITIONS		TEMP ( $^\circ C$ )	MIN (Note 14)	TYP	MAX (Note 14)	UNITS
$I_{IN1}$	Logic Input Current	DI		Full	<b>-1</b>	-	<b>1</b>	$\mu A$
		DE, $\overline{RE}$		Full	<b>-15</b>	6	<b>15</b>	$\mu A$
$I_{IN2}$	Input/Output Current (A/Y, B/Z)	DE = 0V, $V_{CC} = 0V$ or $5.5V$	$V_{IN} = 12V$	Full	-	110	<b>250</b>	$\mu A$
			$V_{IN} = -7V$	Full	<b>-200</b>	-75	-	$\mu A$
			$V_{IN} = \pm 25V$	Full	<b>-800</b>	$\pm 240$	<b>800</b>	$\mu A$
			$V_{IN} = \pm 60V$ (Note 16)	Full	<b>-6</b>	$\pm 0.5$	<b>6</b>	mA
$I_{IN3}$	Input Current (A, B) (Full Duplex Versions Only)	$V_{CC} = 0V$ or $5.5V$	$V_{IN} = 12V$	Full	-	90	<b>125</b>	$\mu A$
			$V_{IN} = -7V$	Full	<b>-100</b>	-70	-	$\mu A$
			$V_{IN} = \pm 25V$	Full	<b>-500</b>	$\pm 200$	<b>500</b>	$\mu A$
			$V_{IN} = \pm 60V$ (Note 16)	Full	<b>-3</b>	$\pm 0.4$	<b>3</b>	mA
$I_{OZD}$	Output Leakage Current (Y, Z) (Full Duplex Versions Only)	$\overline{RE} = 0V$ , DE = 0V, $V_{CC} = 0V$ or $5.5V$	$V_{IN} = 12V$	Full	-	20	<b>200</b>	$\mu A$
			$V_{IN} = -7V$	Full	<b>-100</b>	-5	-	$\mu A$
			$V_{IN} = \pm 25V$	Full	<b>-500</b>	$\pm 40$	<b>500</b>	$\mu A$
			$V_{IN} = \pm 60V$ (Note 16)	Full	<b>-3</b>	$\pm 0.1$	<b>3</b>	mA
$V_{TH}$	Receiver Differential Threshold Voltage	$-25V \leq V_{CM} \leq 25V$		Full	<b>-200</b>	-100	<b>-10</b>	mV
$\Delta V_{TH}$	Receiver Input Hysteresis	$-25V \leq V_{CM} \leq 25V$		25	-	25	-	mV
$V_{OH}$	Receiver Output High Voltage	$I_O = -2mA$ , $V_{ID} = -10mV$		Full	<b><math>V_{CC} - 0.5</math></b>	4.75	-	V
		$I_O = -8mA$ , $V_{ID} = -10mV$		Full	<b>2.8</b>	4.2	-	V
$V_{OL}$	Receiver Output Low Voltage	$I_O = 6mA$ , $V_{ID} = -200mV$		Full	-	0.27	<b>0.4</b>	V
$I_{OL}$	Receiver Output Low Current	$V_O = 1V$ , $V_{ID} = -200mV$		Full	<b>15</b>	22	-	mA
$I_{OZR}$	Three-state (High Impedance) Receiver Output Current	$0V \leq V_O \leq V_{CC}$		Full	<b>-1</b>	0.01	<b>1</b>	$\mu A$
$I_{OSR}$	Receiver Short-circuit Current	$0V \leq V_O \leq V_{CC}$		Full	<b><math>\pm 12</math></b>	-	<b><math>\pm 110</math></b>	mA
<b>SUPPLY CURRENT</b>								
$I_{CC}$	No Load Supply Current (Note 7)	DE = $V_{CC}$ , $\overline{RE} = 0V$ or $V_{CC}$ , DI = $0V$ or $V_{CC}$		Full	-	2.3	<b>4.5</b>	mA
$I_{SHDN}$	Shutdown Supply Current	DE = $0V$ , $\overline{RE} = V_{CC}$ , DI = $0V$ or $V_{CC}$		Full	-	10	<b>50</b>	$\mu A$
<b>ESD PERFORMANCE</b>								
	RS-485 Pins (A, Y, B, Z, A/Y, B/Z)	Human Body Model, From Bus Pins to GND	1/2 Duplex	25	-	$\pm 16.5$	-	kV
			Full Duplex	25	-	$\pm 15$	-	kV
	All Pins	Human Body Model, per JEDEC		25	-	$\pm 8$	-	kV
		Machine Model		25	-	$\pm 700$	-	V
<b>DRIVER SWITCHING CHARACTERISTICS (250kbps Versions; ISL32490E, ISL32492E)</b>								
$t_{PLH}$ , $t_{PHL}$	Driver Differential Output Delay	$R_D = 54\Omega$ , $C_D = 50pF$ (Figure 6)	No CM Load	Full	-	320	<b>450</b>	ns
			$-25V \leq V_{CM} \leq 25V$	Full	-	-	<b>1000</b>	ns
$t_{SKEW}$	Driver Differential Output Skew	$R_D = 54\Omega$ , $C_D = 50pF$ (Figure 6)	No CM Load	Full	-	6	<b>30</b>	ns
			$-25V \leq V_{CM} \leq 25V$	Full	-	-	<b>50</b>	ns

# ISL32490E, ISL32492E, ISL32493E, ISL32495E, ISL32496E, ISL32498E

**Electrical Specifications**  $V_{CC} = 4.5V$  to  $5.5V$ ; Unless Otherwise Specified. Typical values are at  $V_{CC} = 5V$ ,  $T_A = +25^\circ C$  (Note 6). **Boldface limits apply across the operating temperature range,  $-40^\circ C$  to  $+85^\circ C$ .** (Continued)

SYMBOL	PARAMETER	TEST CONDITIONS	TEMP (°C)	MIN (Note 14)	TYP	MAX (Note 14)	UNITS	
$t_R, t_F$	Driver Differential Rise or Fall Time	$R_D = 54\Omega$ , $C_D = 50pF$ (Figure 6)	No CM Load	Full	<b>400</b>	650	<b>1200</b>	ns
			$-25V \leq V_{CM} \leq 25V$	Full	<b>300</b>	-	<b>1350</b>	ns
$f_{MAX}$	Maximum Data Rate	$C_D = 820pF$ (Figure 8)	Full	<b>0.25</b>	1.5	-	Mbps	
$t_{ZH}$	Driver Enable to Output High	SW = GND (Figure 7), (Note 9)	Full	-	-	<b>1200</b>	ns	
$t_{ZL}$	Driver Enable to Output Low	SW = $V_{CC}$ (Figure 7), (Note 9)	Full	-	-	<b>1200</b>	ns	
$t_{LZ}$	Driver Disable from Output Low	SW = $V_{CC}$ (Figure 7)	Full	-	-	<b>120</b>	ns	
$t_{HZ}$	Driver Disable from Output High	SW = GND (Figure 7)	Full	-	-	<b>120</b>	ns	
$t_{SHDN}$	Time to Shutdown	(Note 11)	Full	<b>60</b>	160	<b>600</b>	ns	
$t_{ZH}(SHDN)$	Driver Enable from Shutdown to Output High	SW = GND (Figure 7), (Notes 11, 12)	Full	-	-	<b>2500</b>	ns	
$t_{ZL}(SHDN)$	Driver Enable from Shutdown to Output Low	SW = $V_{CC}$ (Figure 7), (Notes 11, 12)	Full	-	-	<b>2500</b>	ns	

## DRIVER SWITCHING CHARACTERISTICS (1Mbps Versions; ISL32493E, ISL32495E)

$t_{PLH}, t_{PHL}$	Driver Differential Output Delay	$R_D = 54\Omega$ , $C_D = 50pF$ (Figure 6)	No CM Load	Full	-	70	<b>125</b>	ns
			$-25V \leq V_{CM} \leq 25V$	Full	-	-	<b>350</b>	ns
$t_{SKEW}$	Driver Differential Output Skew	$R_D = 54\Omega$ , $C_D = 50pF$ (Figure 6)	No CM Load	Full	-	4.5	<b>15</b>	ns
			$-25V \leq V_{CM} \leq 25V$ (Note 17)	Full	-	-	<b>25</b>	ns
$t_R, t_F$	Driver Differential Rise or Fall Time	$R_D = 54\Omega$ , $C_D = 50pF$ (Figure 6)	No CM Load	Full	<b>70</b>	170	<b>300</b>	ns
			$-25V \leq V_{CM} \leq 25V$	Full	<b>70</b>	-	<b>550</b>	ns
$f_{MAX}$	Maximum Data Rate	$C_D = 820pF$ (Figure 8)	Full	<b>1</b>	4	-	Mbps	
$t_{ZH}$	Driver Enable to Output High	SW = GND (Figure 7), (Note 9)	Full	-	-	<b>350</b>	ns	
$t_{ZL}$	Driver Enable to Output Low	SW = $V_{CC}$ (Figure 7), (Note 9)	Full	-	-	<b>300</b>	ns	
$t_{LZ}$	Driver Disable from Output Low	SW = $V_{CC}$ (Figure 7)	Full	-	-	<b>120</b>	ns	
$t_{HZ}$	Driver Disable from Output High	SW = GND (Figure 7)	Full	-	-	<b>120</b>	ns	
$t_{SHDN}$	Time to Shutdown	(Note 11)	Full	<b>60</b>	160	<b>600</b>	ns	
$t_{ZH}(SHDN)$	Driver Enable from Shutdown to Output High	SW = GND (Figure 7), (Notes 11, 12)	Full	-	-	<b>2000</b>	ns	
$t_{ZL}(SHDN)$	Driver Enable from Shutdown to Output Low	SW = $V_{CC}$ (Figure 7), (Notes 11, 12)	Full	-	-	<b>2000</b>	ns	

## DRIVER SWITCHING CHARACTERISTICS (15Mbps Versions; ISL32496E, ISL32498E)

$t_{PLH}, t_{PHL}$	Driver Differential Output Delay	$R_D = 54\Omega$ , $C_D = 50pF$ (Figure 6)	No CM Load	Full	-	21	<b>45</b>	ns
			$-25V \leq V_{CM} \leq 25V$	Full	-	-	<b>80</b>	ns
$t_{SKEW}$	Driver Differential Output Skew	$R_D = 54\Omega$ , $C_D = 50pF$ (Figure 6)	No CM Load	Full	-	3	<b>6</b>	ns
			$-25V \leq V_{CM} \leq 25V$	Full	-	-	<b>7</b>	ns

# ISL32490E, ISL32492E, ISL32493E, ISL32495E, ISL32496E, ISL32498E

**Electrical Specifications**  $V_{CC} = 4.5V$  to  $5.5V$ ; Unless Otherwise Specified. Typicals are at  $V_{CC} = 5V$ ,  $T_A = +25^\circ C$  (Note 6). **Boldface limits apply across the operating temperature range,  $-40^\circ C$  to  $+85^\circ C$ .** (Continued)

SYMBOL	PARAMETER	TEST CONDITIONS	TEMP (°C)	MIN (Note 14)	TYP	MAX (Note 14)	UNITS	
$t_R, t_F$	Driver Differential Rise or Fall Time	$R_D = 54\Omega$ , $C_D = 50pF$ (Figure 6)	No CM Load	Full	<b>5</b>	17	<b>30</b>	ns
			$-25V \leq V_{CM} \leq 25V$	Full	<b>5</b>	-	<b>30</b>	ns
$f_{MAX}$	Maximum Data Rate	$C_D = 470pF$ (Figure 8)	Full	<b>15</b>	25	-	Mbps	
$t_{ZH}$	Driver Enable to Output High	$SW = GND$ (Figure 7), (Note 9)	Full	-	-	<b>100</b>	ns	
$t_{ZL}$	Driver Enable to Output Low	$SW = V_{CC}$ (Figure 7), (Note 9)	Full	-	-	<b>100</b>	ns	
$t_{LZ}$	Driver Disable from Output Low	$SW = V_{CC}$ (Figure 7)	Full	-	-	<b>120</b>	ns	
$t_{HZ}$	Driver Disable from Output High	$SW = GND$ (Figure 7)	Full	-	-	<b>120</b>	ns	
$t_{SHDN}$	Time to Shutdown	(Note 11)	Full	<b>60</b>	160	<b>600</b>	ns	
$t_{ZH}(SHDN)$	Driver Enable from Shutdown to Output High	$SW = GND$ (Figure 7), (Notes 11, 12)	Full	-	-	<b>2000</b>	ns	
$t_{ZL}(SHDN)$	Driver Enable from Shutdown to Output Low	$SW = V_{CC}$ (Figure 7), (Notes 11, 12)	Full	-	-	<b>2000</b>	ns	
<b>RECEIVER SWITCHING CHARACTERISTICS (250kbps Versions; ISL32490E, ISL32492E)</b>								
$f_{MAX}$	Maximum Data Rate	$-25V \leq V_{CM} \leq 25V$ (Figure 9)	Full	<b>0.25</b>	5	-	Mbps	
$t_{PLH}, t_{PHL}$	Receiver Input to Output Delay	$-25V \leq V_{CM} \leq 25V$ (Figure 9)	Full	-	200	<b>280</b>	ns	
$t_{SKD}$	Receiver Skew   $t_{PLH} - t_{PHL}$	(Figure 9)	Full	-	4	<b>10</b>	ns	
$t_{ZL}$	Receiver Enable to Output Low	$R_L = 1k\Omega$ , $C_L = 15pF$ , $SW = V_{CC}$ (Figure 10), (Note 10)	Full	-	-	<b>50</b>	ns	
$t_{ZH}$	Receiver Enable to Output High	$R_L = 1k\Omega$ , $C_L = 15pF$ , $SW = GND$ (Figure 10), (Note 10)	Full	-	-	<b>50</b>	ns	
$t_{LZ}$	Receiver Disable from Output Low	$R_L = 1k\Omega$ , $C_L = 15pF$ , $SW = V_{CC}$ (Figure 10)	Full	-	-	<b>50</b>	ns	
$t_{HZ}$	Receiver Disable from Output High	$R_L = 1k\Omega$ , $C_L = 15pF$ , $SW = GND$ (Figure 10)	Full	-	-	<b>50</b>	ns	
$t_{SHDN}$	Time to Shutdown	(Note 11)	Full	<b>60</b>	160	<b>600</b>	ns	
$t_{ZH}(SHDN)$	Receiver Enable from Shutdown to Output High	$R_L = 1k\Omega$ , $C_L = 15pF$ , $SW = GND$ (Figure 10), (Notes 11, 13)	Full	-	-	<b>2000</b>	ns	
$t_{ZL}(SHDN)$	Receiver Enable from Shutdown to Output Low	$R_L = 1k\Omega$ , $C_L = 15pF$ , $SW = V_{CC}$ (Figure 10), (Notes 11, 13)	Full	-	-	<b>2000</b>	ns	
<b>RECEIVER SWITCHING CHARACTERISTICS (1Mbps Versions; ISL32493E, ISL32495E)</b>								
$f_{MAX}$	Maximum Data Rate	$-25V \leq V_{CM} \leq 25V$ (Figure 9)	Full	<b>1</b>	15	-	Mbps	
$t_{PLH}, t_{PHL}$	Receiver Input to Output Delay	$-25V \leq V_{CM} \leq 25V$ (Figure 9)	Full	-	90	<b>150</b>	ns	
$t_{SKD}$	Receiver Skew   $t_{PLH} - t_{PHL}$	(Figure 9)	Full	-	4	<b>10</b>	ns	
$t_{ZL}$	Receiver Enable to Output Low	$R_L = 1k\Omega$ , $C_L = 15pF$ , $SW = V_{CC}$ (Figure 10), (Note 10)	Full	-	-	<b>50</b>	ns	
$t_{ZH}$	Receiver Enable to Output High	$R_L = 1k\Omega$ , $C_L = 15pF$ , $SW = GND$ (Figure 10), (Note 10)	Full	-	-	<b>50</b>	ns	
$t_{LZ}$	Receiver Disable from Output Low	$R_L = 1k\Omega$ , $C_L = 15pF$ , $SW = V_{CC}$ (Figure 10)	Full	-	-	<b>50</b>	ns	
$t_{HZ}$	Receiver Disable from Output High	$R_L = 1k\Omega$ , $C_L = 15pF$ , $SW = GND$ (Figure 10)	Full	-	-	<b>50</b>	ns	
$t_{SHDN}$	Time to Shutdown	(Note 11)	Full	<b>60</b>	160	<b>600</b>	ns	



# ISL32490E, ISL32492E, ISL32493E, ISL32495E, ISL32496E, ISL32498E

**Electrical Specifications**  $V_{CC} = 4.5V$  to  $5.5V$ ; Unless Otherwise Specified. Typical values are at  $V_{CC} = 5V$ ,  $T_A = +25^\circ C$  (Note 6). **Boldface limits apply across the operating temperature range,  $-40^\circ C$  to  $+85^\circ C$ .** (Continued)

SYMBOL	PARAMETER	TEST CONDITIONS	TEMP (°C)	MIN (Note 14)	TYP	MAX (Note 14)	UNITS
$t_{ZH}(SHDN)$	Receiver Enable from Shutdown to Output High	$R_L = 1k\Omega$ , $C_L = 15pF$ , SW = GND (Figure 10), (Notes 11, 13)	Full	-	-	<b>2000</b>	ns
$t_{ZL}(SHDN)$	Receiver Enable from Shutdown to Output Low	$R_L = 1k\Omega$ , $C_L = 15pF$ , SW = $V_{CC}$ (Figure 10), (Notes 11, 13)	Full	-	-	<b>2000</b>	ns
<b>RECEIVER SWITCHING CHARACTERISTICS (15Mbps Versions; ISL32496E, ISL32498E)</b>							
$f_{MAX}$	Maximum Data Rate	$-25V \leq V_{CM} \leq 25V$ (Figure 9)	Full	<b>15</b>	25	-	Mbps
$t_{PLH}$ , $t_{PHL}$	Receiver Input to Output Delay	$-25V \leq V_{CM} \leq 25V$ (Figure 9)	Full	-	35	<b>70</b>	ns
$t_{SKD}$	Receiver Skew   $t_{PLH} - t_{PHL}$	(Figure 9)	Full	-	4	<b>10</b>	ns
$t_{ZL}$	Receiver Enable to Output Low	$R_L = 1k\Omega$ , $C_L = 15pF$ , SW = $V_{CC}$ (Figure 10), (Note 10)	Full	-	-	<b>50</b>	ns
$t_{ZH}$	Receiver Enable to Output High	$R_L = 1k\Omega$ , $C_L = 15pF$ , SW = GND (Figure 10), (Note 10)	Full	-	-	<b>50</b>	ns
$t_{LZ}$	Receiver Disable from Output Low	$R_L = 1k\Omega$ , $C_L = 15pF$ , SW = $V_{CC}$ (Figure 10)	Full	-	-	<b>50</b>	ns
$t_{HZ}$	Receiver Disable from Output High	$R_L = 1k\Omega$ , $C_L = 15pF$ , SW = GND (Figure 10)	Full	-	-	<b>50</b>	ns
$t_{SHDN}$	Time to Shutdown	(Note 11)	Full	<b>60</b>	160	<b>600</b>	ns
$t_{ZH}(SHDN)$	Receiver Enable from Shutdown to Output High	$R_L = 1k\Omega$ , $C_L = 15pF$ , SW = GND (Figure 10), (Notes 11, 13)	Full	-	-	<b>2000</b>	ns
$t_{ZL}(SHDN)$	Receiver Enable from Shutdown to Output Low	$R_L = 1k\Omega$ , $C_L = 15pF$ , SW = $V_{CC}$ (Figure 10), (Notes 11, 13)	Full	-	-	<b>2000</b>	ns

**NOTES:**

- All currents into device pins are positive; all currents out of device pins are negative. All voltages are referenced to device ground unless otherwise specified.
- Supply current specification is valid for loaded drivers when  $DE = 0V$ .
- Applies to peak current. See "Typical Performance Curves" beginning on page 14 for more information.
- Keep  $\overline{RE} = 0$  to prevent the device from entering SHDN.
- The  $\overline{RE}$  signal high time must be short enough (typically <100ns) to prevent the device from entering SHDN.
- Transceivers are put into shutdown by bringing  $\overline{RE}$  high and DE low. If the inputs are in this state for less than 60ns, the parts are guaranteed not to enter shutdown. If the inputs are in this state for at least 600ns, the parts are guaranteed to have entered shutdown. See "Low Power Shutdown Mode" on page 13.
- Keep  $\overline{RE} = V_{CC}$ , and set the DE signal low time >600ns to ensure that the device enters SHDN.
- Set the  $\overline{RE}$  signal high time >600ns to ensure that the device enters SHDN.
- Compliance to data sheet limits is assured by one or more methods: production test, characterization and/or design.
- Tested according to TIA/EIA-485-A, Section 4.2.6 ( $\pm 80V$  for 15 $\mu s$  at a 1% duty cycle).
- See "Caution" statement below the "Latch-up (Tested per JESD78, Level 2, Class A) +125°C" on page 5.
- This parameter is not production tested.

## Test Circuits and Waveforms

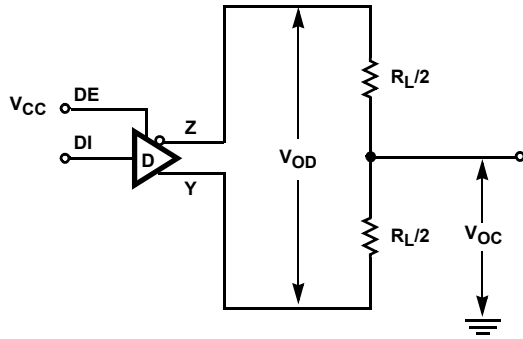

FIGURE 5A.  $V_{OD}$  AND  $V_{OC}$

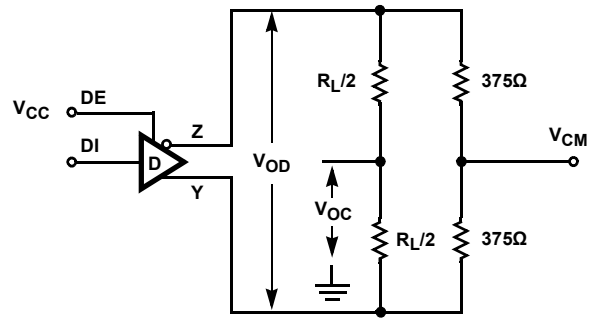

FIGURE 5B.  $V_{OD}$  AND  $V_{OC}$  WITH COMMON MODE LOAD

FIGURE 5. DC DRIVER TEST CIRCUITS

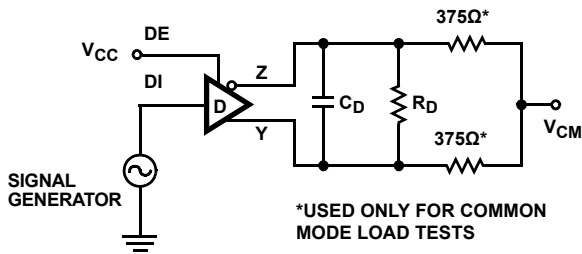

FIGURE 6A. TEST CIRCUIT

FIGURE 6. DRIVER PROPAGATION DELAY AND DIFFERENTIAL TRANSITION TIMES

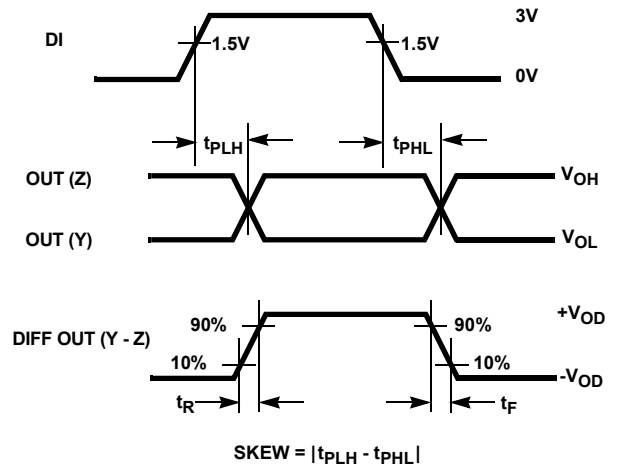

FIGURE 6B. MEASUREMENT POINTS

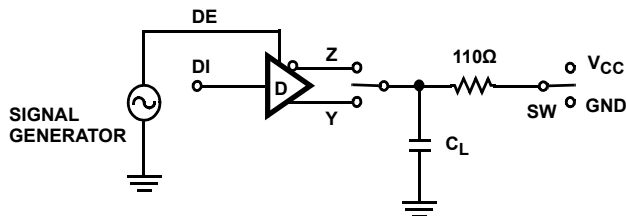

FIGURE 7A. TEST CIRCUIT

FIGURE 7. DRIVER ENABLE AND DISABLE TIMES

PARAMETER	OUTPUT	$\overline{RE}$	DI	SW	$C_L$ (pF)
$t_{HZ}$	Y/Z	X	1/0	GND	50
$t_{LZ}$	Y/Z	X	0/1	$V_{CC}$	50
$t_{ZH}$	Y/Z	0 (Note 9)	1/0	GND	100
$t_{ZL}$	Y/Z	0 (Note 9)	0/1	$V_{CC}$	100
$t_{ZH(SHDN)}$	Y/Z	1 (Note 12)	1/0	GND	100
$t_{ZL(SHDN)}$	Y/Z	1 (Note 12)	0/1	$V_{CC}$	100

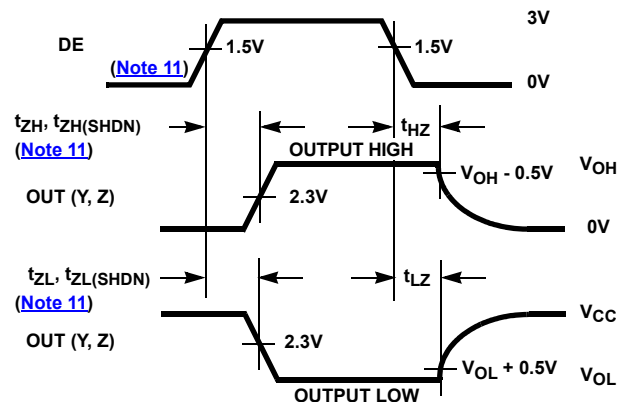

FIGURE 7B. MEASUREMENT POINTS

## Test Circuits and Waveforms (Continued)

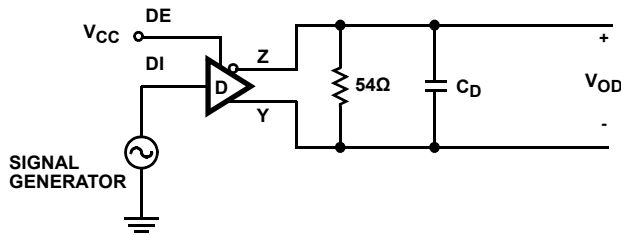

FIGURE 8A. TEST CIRCUIT

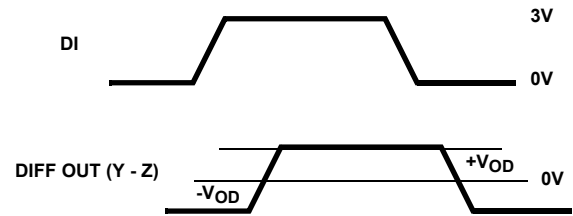

FIGURE 8B. MEASUREMENT POINTS

FIGURE 8. DRIVER DATA RATE

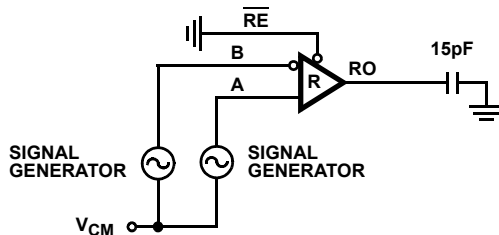

FIGURE 9A. TEST CIRCUIT

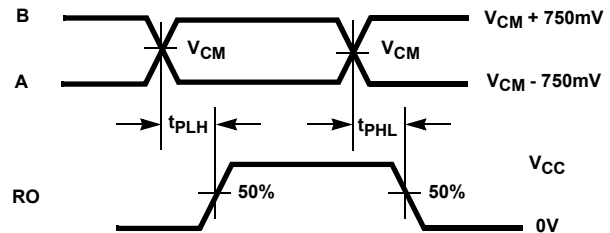
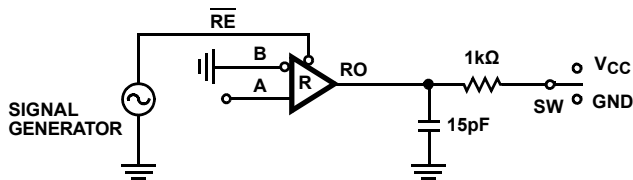

FIGURE 9B. MEASUREMENT POINTS

FIGURE 9. RECEIVER PROPAGATION DELAY AND DATA RATE



PARAMETER	DE	A	SW
$t_{HZ}$	0	+1.5V	GND
$t_{LZ}$	0	-1.5V	$V_{CC}$
$t_{ZH}$ (Note 10)	0	+1.5V	GND
$t_{ZL}$ (Note 10)	0	-1.5V	$V_{CC}$
$t_{ZH}(SHDN)$ (Note 13)	0	+1.5V	GND
$t_{ZL}(SHDN)$ (Note 13)	0	-1.5V	$V_{CC}$

FIGURE 10A. TEST CIRCUIT

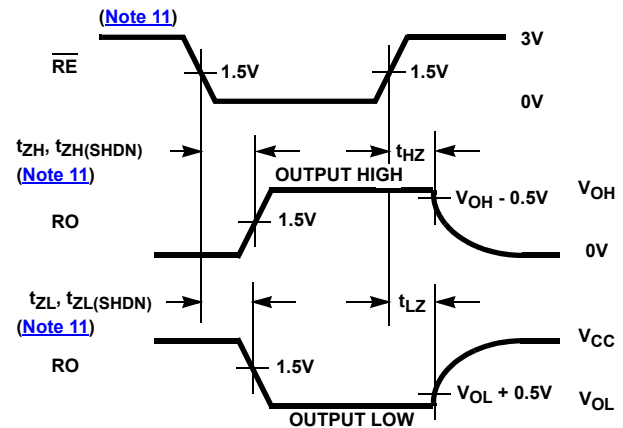

FIGURE 10B. MEASUREMENT POINTS

FIGURE 10. RECEIVER ENABLE AND DISABLE TIMES

## Application Information

RS-485 and RS-422 are differential (balanced) data transmission standards used for long haul or noisy environments. RS-422 is a subset of RS-485, so RS-485 transceivers are also RS-422 compliant. RS-422 is a point-to-multipoint (multidrop) standard, which allows only one driver and up to 10 (assuming one-unit load devices) receivers on each bus. RS-485 is a true multipoint standard, which allows up to 32 one-unit load devices (any combination of drivers and receivers) on each bus. To allow for multipoint operation, the RS-485 specification requires that

drivers must handle bus contention without sustaining any damage.

Another important advantage of RS-485 is the extended common mode range (CMR), which specifies that the driver outputs and receiver inputs withstand signals that range from +12V to -7V. RS-422 and RS-485 are intended for runs as long as 4000 feet; thus, the wide CMR is necessary to handle ground potential differences, as well as voltages induced in the cable by external fields.

The ISL3249xE is a family of ruggedized RS-485 transceivers that improves on the RS-485 basic requirements and thereby

increases system reliability. The CMR increases to  $\pm 25V$ , while the RS-485 bus pins (receiver inputs and driver outputs) include fault protection against voltages and transients up to  $\pm 60V$ . Additionally, larger than required differential output voltages ( $V_{OD}$ ) increase noise immunity, while the  $\pm 16.5kV$  built-in ESD protection complements the fault protection.

## Receiver (Rx) Features

These devices utilize a differential input receiver for maximum noise immunity and common mode rejection. Input sensitivity is better than  $\pm 200mV$ , as required by the RS-422 and RS-485 specifications.

Receiver input (load) current surpasses the RS-422 specification of 3mA and is four times lower than the RS-485 "Unit Load (UL)" requirement of 1mA maximum. Thus, these products are known as "one-quarter UL" transceivers, and there can be up to 128 of these devices on a network while still complying with the RS-485 loading specification.

The Rx functions with common mode voltages as great as  $\pm 25V$ , making them ideal for industrial or long networks where induced voltages are a realistic concern.

All the receivers include a "full fail-safe" function that guarantees a high-level receiver output if the receiver inputs are unconnected (floating), shorted together, or connected to a terminated bus with all the transmitters disabled (i.e., an idle bus).

Rx outputs feature high drive levels (typically 22mA at  $V_{OL} = 1V$ ) to ease the design of optically coupled isolated interfaces.

Receivers easily meet the data rates supported by the corresponding driver, and all receiver outputs are three-statable via the active low  $\overline{RE}$  input.

The Rx in the 250kbps and 1Mbps versions include noise filtering circuitry to reject high-frequency signals. The 1Mbps version typically rejects pulses narrower than 50ns (equivalent to 20Mbps), while the 250kbps Rx rejects pulses below 150ns (6.7Mbps).

## Driver (Tx) Features

The RS-485/RS-422 driver is a differential output device that delivers at least 1.5V across a  $54\Omega$  load (RS-485) and at least 2.4V across a  $100\Omega$  load (RS-422). The drivers feature low propagation delay skew to maximize bit width and minimize EMI, and all drivers are three-statable via the active high DE input.

The 250kbps and 1Mbps driver outputs are slew rate limited to minimize EMI and to minimize reflections in unterminated or improperly terminated networks. Outputs of the ISL32496E and ISL32498E drivers are not limited; thus, faster output transition times allow data rates of at least 15Mbps.

## High Overvoltage (Fault) Protection Increases Ruggedness

NOTE: The available smaller pitch package (MSOP) may not meet the creepage and clearance (C&C) requirements for  $\pm 60V$  levels. The user is advised to determine his C&C requirements before selecting a package type.

The  $\pm 60V$  (referenced to the IC GND) fault protection on the RS-485 pins makes these transceivers some of the most rugged

on the market. This level of protection makes the ISL3249xE perfect for applications where power (e.g., 24V and 48V supplies) must be routed in the conduit with the data lines or for outdoor applications where large transients are likely to occur. When power is routed with the data lines, even a momentary short between the supply and data lines will destroy an unprotected device. The  $\pm 60V$  fault levels of this family are at least **5x higher** than the levels specified for standard RS-485 ICs. The ISL3249xE protection is active whether the Tx is enabled or disabled, and even if the IC is powered down.

If transients or voltages (including overshoots and ringing) greater than  $\pm 60V$  are possible, then additional external protection is required.

## Widest Common Mode Voltage (CMV) Tolerance Improves Operating Range

RS-485 networks operating in industrial complexes or over long distances are susceptible to large CMV variations. Either of these operating environments may suffer from large node-to-node ground potential differences or CMV pickup from external electromagnetic sources, and devices with only the minimum required  $+12V$  to  $-7V$  CMR may malfunction. The ISL3249xE's extended  $\pm 25V$  CMR is the widest available, allowing operation in environments that would overwhelm lesser transceivers. Additionally, the Rx will not phase invert (erroneously change state), even with CMVs of  $\pm 40V$  or differential voltages as large as 40V.

## High $V_{OD}$ Improves Noise Immunity and Flexibility

The ISL3249xE driver design delivers larger differential output voltages ( $V_{OD}$ ) than the RS-485 standard requires or than most RS-485 transmitters can deliver. The typical  $\pm 2.5V$   $V_{OD}$  provides more noise immunity than networks built using many other transceivers.

Another advantage of the large  $V_{OD}$  is the ability to drive more than two bus terminations, which allows for utilizing the ISL3249xE in "star" and other multi-terminated, nonstandard network topologies. [Figure 12 on page 14](#) details the transmitter's  $V_{OD}$  vs  $I_{OUT}$  characteristic and includes load lines for four ( $30\Omega$ ) and six ( $20\Omega$ )  $120\Omega$  terminations. [Figure 12](#) shows that the driver typically delivers  $\pm 1.3V$  into six terminations and the "[Electrical Specifications](#)" on [page 5](#) guarantees a  $V_{OD}$  of  $\pm 0.8V$  at 21 $\Omega$  over the full temperature range. The RS-485 standard requires a minimum 1.5V  $V_{OD}$  into two terminations, but the ISL3249xE deliver RS-485 voltage levels with 2x to 3x the number of terminations.

## Hot Plug Function

When a piece of equipment powers up, there is a period of time during which the processor or ASIC driving the RS-485 control lines (DE,  $\overline{RE}$ ) is unable to ensure that the RS-485 Tx and Rx outputs are kept disabled. If the equipment is connected to the bus, a driver activating prematurely during power-up may crash the bus. To avoid this scenario, the ISL3249xE devices incorporate a "Hot Plug" function. Circuitry monitoring  $V_{CC}$  ensures that during power-up and power-down, the Tx and Rx outputs remain disabled, regardless of the state of DE and  $\overline{RE}$ , if  $V_{CC}$  is less than

≈3.5V. This gives the processor/ASIC a chance to stabilize and drive the RS-485 control lines to the proper states. Figure 11 illustrates the power-up and power-down performance of the ISL3249xE compared to an RS-485 IC without the Hot Plug feature.

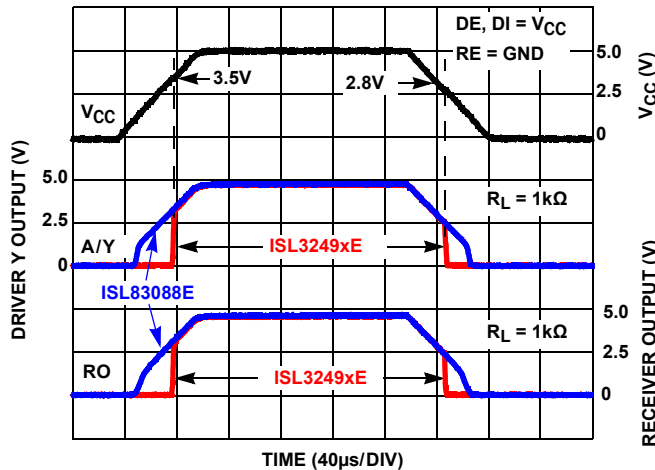

FIGURE 11. HOT PLUG PERFORMANCE (ISL3249xE) vs ISL83088E WITHOUT HOT PLUG CIRCUITRY

## ESD Protection

All pins on these devices include class 3 (>8kV) Human Body Model (HBM) ESD protection structures that are good enough to survive ESD events commonly seen during manufacturing. Even so, the RS-485 pins (driver outputs and receiver inputs) incorporate more advanced structures, allowing them to survive ESD events in excess of ±16.5kV HBM (±15kV for full-duplex version). The RS-485 pins are particularly vulnerable to ESD strikes because they typically connect to an exposed port on the exterior of the finished product. Simply touching the port pins or connecting a cable can cause an ESD event that might destroy unprotected ICs. These new ESD structures protect the device whether or not it is powered up, and without interfering with the exceptional ±25V CMR. This built-in ESD protection minimizes the need for board-level protection structures (e.g., transient suppression diodes) and the associated, undesirable capacitive load they present.

## Data Rate, Cables, and Terminations

RS-485/RS-422 are intended for network lengths up to 4000 feet, but the maximum system data rate decreases as the transmission length increases. Devices operating at 15Mbps may be used at lengths up to 150 feet (46m), but the distance can be increased to 328 feet (100m) by operating at 10Mbps. The 1Mbps versions can operate at full data rates with lengths up to 800 feet (244m). Jitter is the limiting parameter at these faster data rates, so employing encoded data streams (e.g., Manchester coded or Return-to-Zero) may allow increased transmission distances. The slow versions can operate at 115kbps or less at the full 4000-foot (1220m) distance or at 250kbps for lengths up to 3000 feet (915m). DC cable attenuation is the limiting parameter, so using better quality cables (e.g., 22 AWG) may allow increased transmission distance.

Twisted pair is the cable of choice for RS-485/RS-422 networks. Twisted pair cables tend to pick up noise and other electromagnetically induced voltages as common mode signals, which are effectively rejected by the differential receivers in these ICs.

Proper termination is imperative when using the 15Mbps devices, to minimize reflections. Short networks using the 250kbps versions need not be terminated; however, terminations are recommended unless power dissipation is an overriding concern.

In point-to-point or point-to-multipoint (single driver on bus, like RS-422) networks, the main cable should be terminated in its characteristic impedance (typically 120Ω) at the end farthest from the driver. In multireceiver applications, stubs connecting receivers to the main cable should be kept as short as possible. Multipoint (multidriver) systems require that the main cable be terminated in its characteristic impedance at both ends. Stubs connecting a transceiver to the main cable should be kept as short as possible.

## Built-in Driver Overload Protection

As stated previously, the RS-485 specification requires that drivers survive worst-case bus contentions undamaged. These transceivers meet this requirement via driver output short circuit current limits and on-chip thermal shutdown circuitry.

The driver output stages incorporate a double foldback, short circuit current limiting scheme, which ensures that the output current never exceeds the RS-485 specification, even at the common mode and fault condition voltage range extremes. The first foldback current level (≈70mA) is set to ensure that the driver never folds back when driving loads with common mode voltages up to ±25V. The very low second foldback current setting (≈9mA) minimizes power dissipation if the Tx is enabled when a fault occurs.

In the event of a major short circuit condition, devices also include a thermal shutdown feature that disables the drivers whenever the die temperature becomes excessive. This eliminates the power dissipation, allowing the die to cool. The drivers automatically re-enable after the die temperature drops about +15°C. If the contention persists, the thermal shutdown/re-enable cycle repeats until the fault is cleared. Receivers stay operational during thermal shutdown.

## Low Power Shutdown Mode

These BiCMOS transceivers all use a fraction of the power required by competitive devices, but they also include a shutdown feature that reduces the already low quiescent I<sub>CC</sub> to a 10µA trickle. These devices enter shutdown whenever the receiver and driver are *simultaneously* disabled ( $\overline{RE} = V_{CC}$  and  $DE = GND$ ) for a period of at least 600ns. Disabling both the driver and the receiver for less than 60ns guarantees that the transceiver will not enter shutdown.

Note that receiver and driver enable times increase when the transceiver enables from shutdown. Refer to [Notes 9, 10, 11, 12](#) and [13](#), at the end of the “[Electrical Specifications](#)” table on [page 9](#), for more information.

**Typical Performance Curves**  $V_{CC} = 5V, T_A = +25^\circ C$ ; Unless Otherwise Specified.

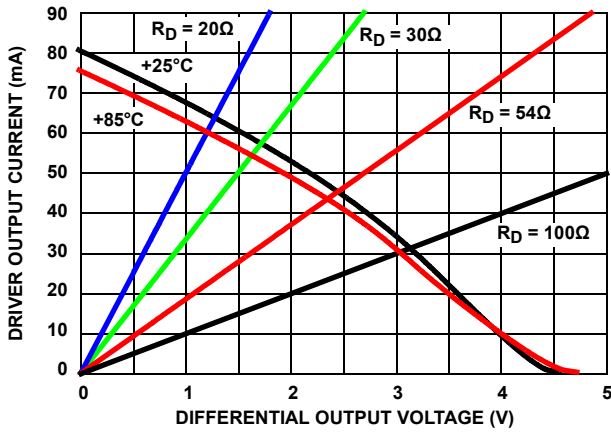

FIGURE 12. DRIVER OUTPUT CURRENT vs DIFFERENTIAL OUTPUT VOLTAGE

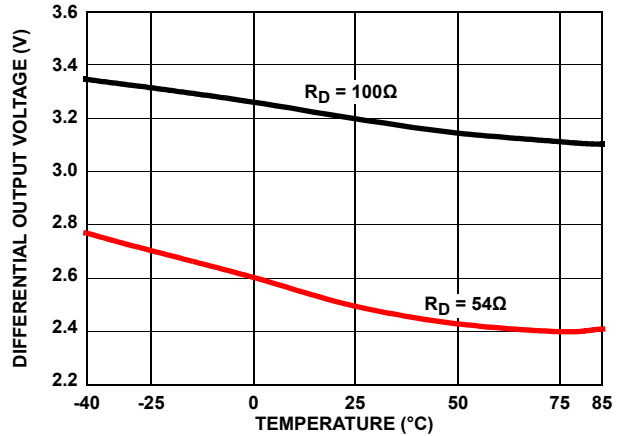

FIGURE 13. DRIVER DIFFERENTIAL OUTPUT VOLTAGE vs TEMPERATURE

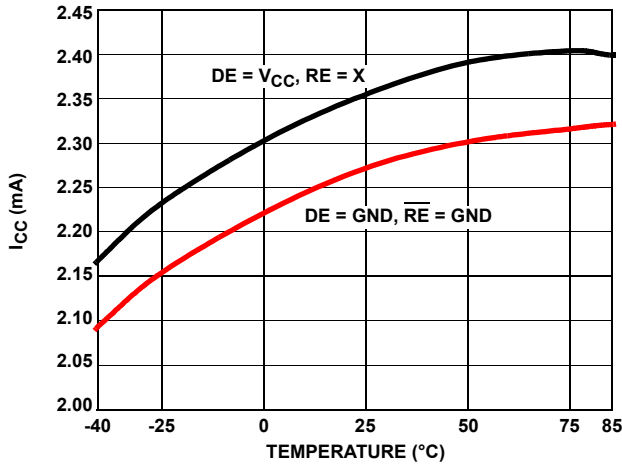

FIGURE 14. SUPPLY CURRENT vs TEMPERATURE

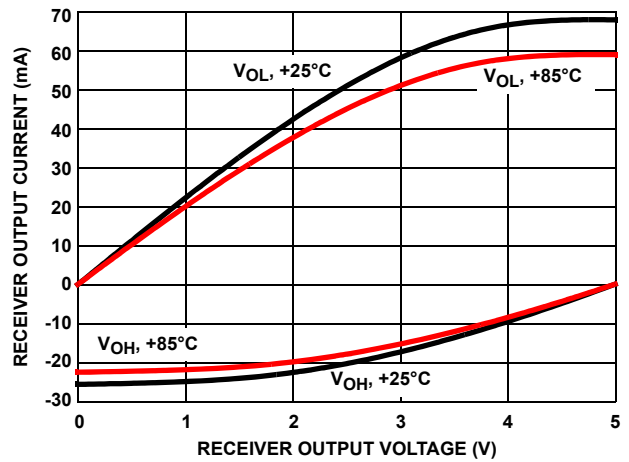

FIGURE 15. RECEIVER OUTPUT CURRENT vs RECEIVER OUTPUT VOLTAGE

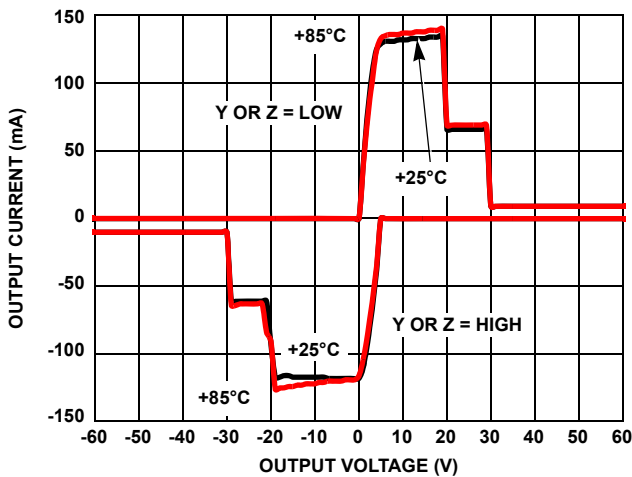

FIGURE 16. DRIVER OUTPUT CURRENT vs SHORT CIRCUIT VOLTAGE

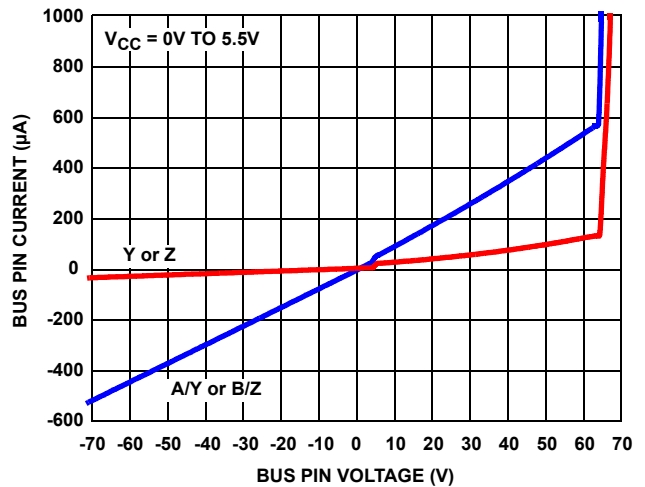

FIGURE 17. BUS PIN CURRENT vs BUS PIN VOLTAGE

**Typical Performance Curves**  $V_{CC} = 5V, T_A = +25^\circ C$ ; Unless Otherwise Specified. (Continued)

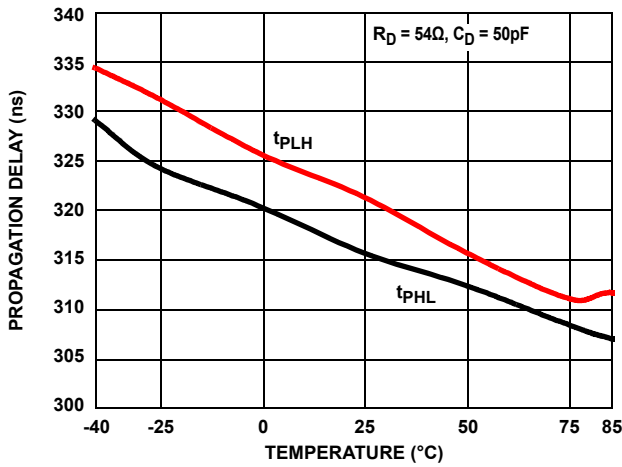

FIGURE 18. DRIVER DIFFERENTIAL PROPAGATION DELAY vs TEMPERATURE (ISL32490E, ISL32492E)

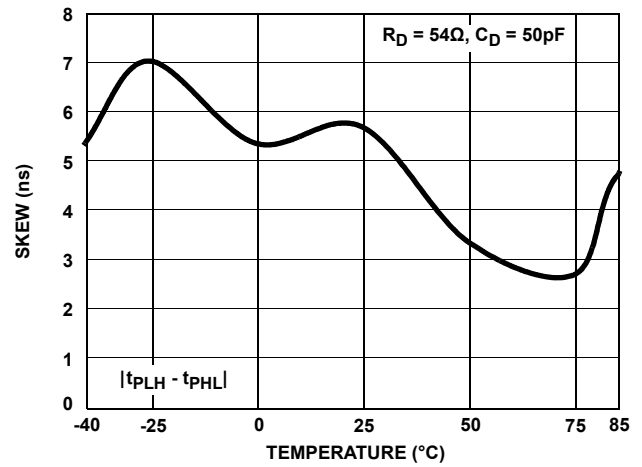

FIGURE 19. DRIVER DIFFERENTIAL SKEW vs TEMPERATURE (ISL32490E, ISL32492E)

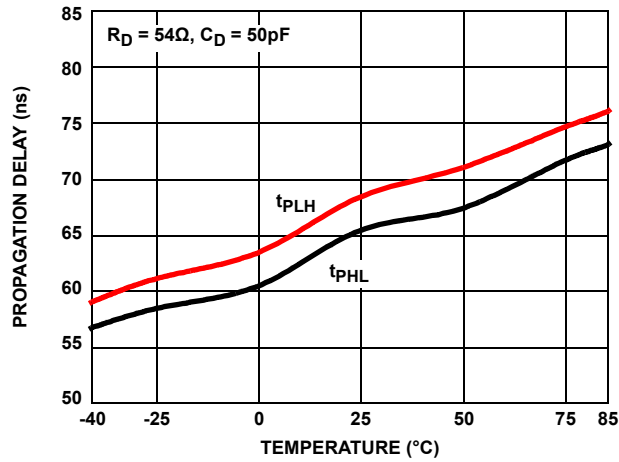

FIGURE 20. DRIVER DIFFERENTIAL PROPAGATION DELAY vs TEMPERATURE (ISL32493E, ISL32495E)

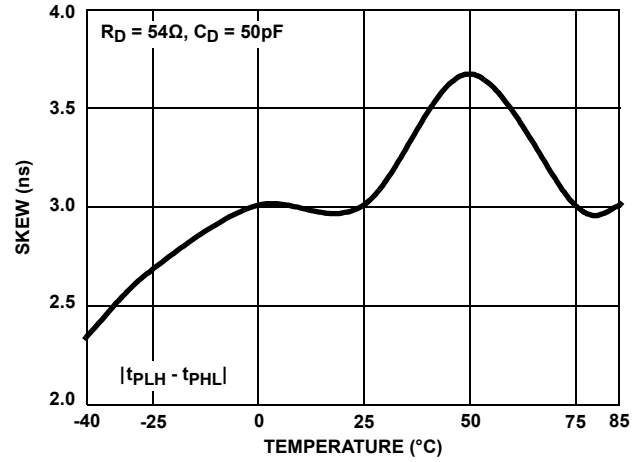

FIGURE 21. DRIVER DIFFERENTIAL SKEW vs TEMPERATURE (ISL32493E, ISL32495E)

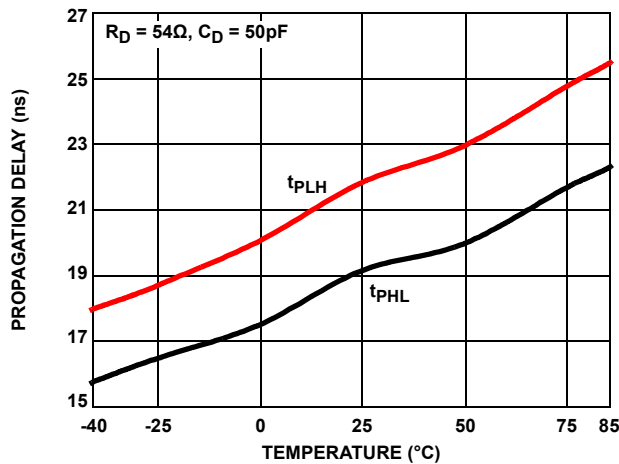

FIGURE 22. DRIVER DIFFERENTIAL PROPAGATION DELAY vs TEMPERATURE (ISL32496E, ISL32498E)

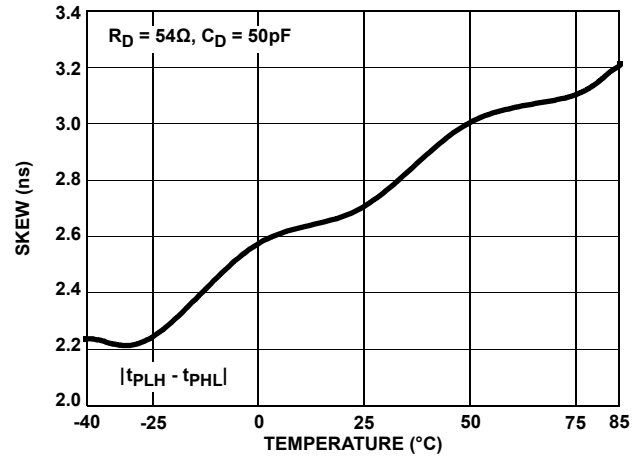

FIGURE 23. DRIVER DIFFERENTIAL SKEW vs TEMPERATURE (ISL32496E, ISL32498E)



**Typical Performance Curves**  $V_{CC} = 5V, T_A = +25^\circ C$ ; Unless Otherwise Specified. (Continued)

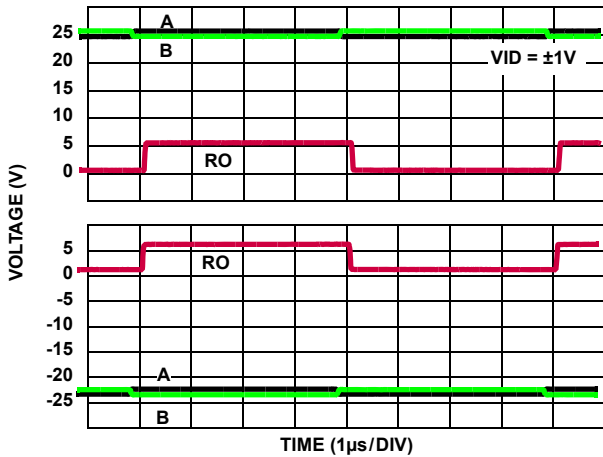

FIGURE 24. RECEIVER PERFORMANCE WITH  $\pm 25V$  CMV (ISL32490E, ISL32492E)

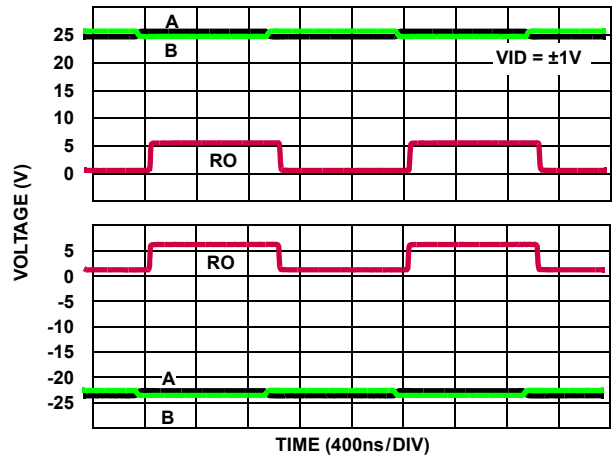

FIGURE 25. RECEIVER PERFORMANCE WITH  $\pm 25V$  CMV (ISL32493E, ISL32495E)

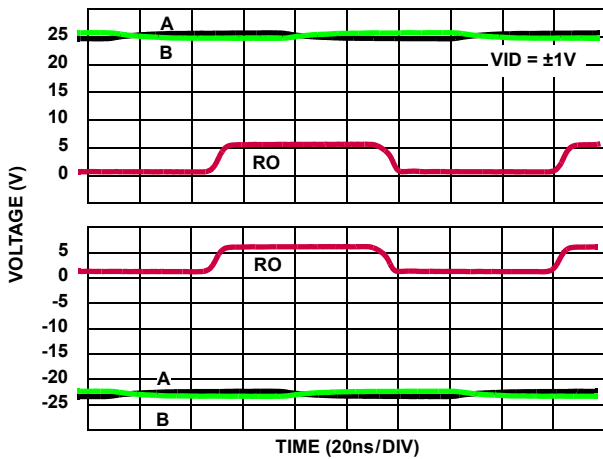

FIGURE 26. RECEIVER PERFORMANCE WITH  $\pm 25V$  CMV (ISL32496E, ISL32498E)

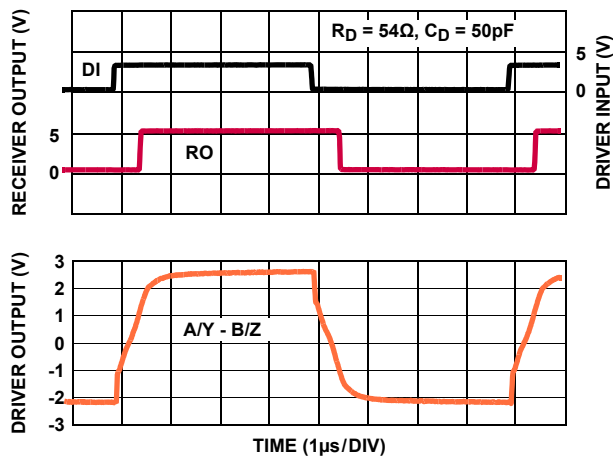

FIGURE 27. DRIVER AND RECEIVER WAVEFORMS (ISL32490E, ISL32492E)

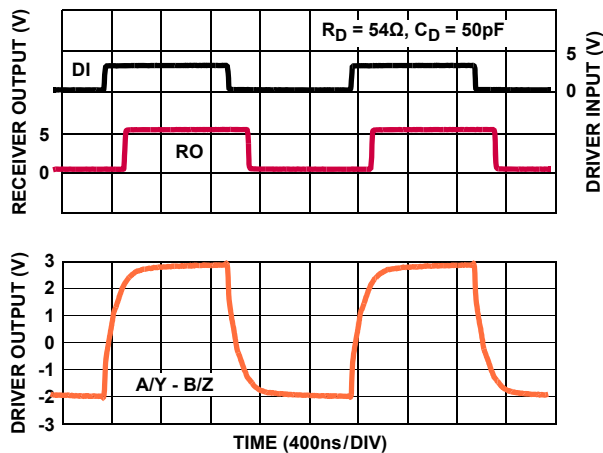

FIGURE 28. DRIVER AND RECEIVER WAVEFORMS (ISL32493E, ISL32495E)

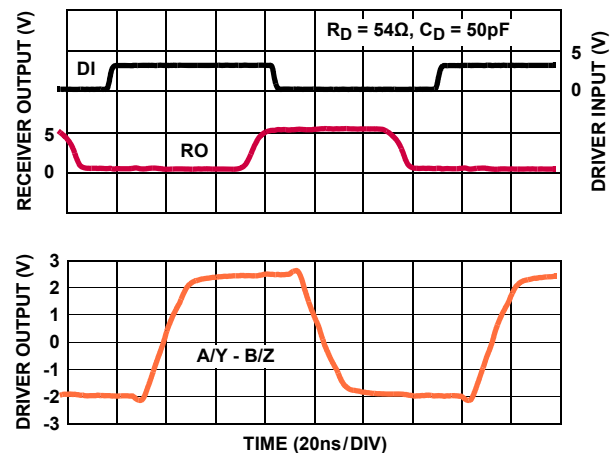

FIGURE 29. DRIVER AND RECEIVER WAVEFORMS (ISL32496E, ISL32498E)



## Die Characteristics

### SUBSTRATE POTENTIAL (POWERED UP):

GND

### PROCESS:

Si Gate BiCMOS

## Revision History

The revision history provided is for informational purposes only and is believed to be accurate, but not warranted. Please go to web to make sure you have the latest revision.

DATE	REVISION	CHANGE
April 20, 2015	FN7786.4	DRIVER SWITCHING CHARACTERISTICS (250kbps Versions; ISL32490E, ISL32492E) Changed MAX limit from "1200" to "1350" in "Driver Differential Rise or Fall Time" on page 7 that has $-25V \leq V_{CM} \leq 25V$ for test condition. DRIVER SWITCHING CHARACTERISTICS (1Mbps Versions; ISL32493E, ISL32495E) Changed MAX limit from "400" to "550" in "Driver Differential Rise or Fall Time" on page 7 that has $-25V \leq V_{CM} \leq 25V$ for test condition.
October 14, 2014	FN7786.3	On page 7, added "Note 17" reference to the Driver Differential Output Test condition. On page 9, added Note 17, "This parameter is not production tested." On page 19 replaced M10.118 POD with latest revision.
March 7, 2012	FN7786.2	Updated Figure 17 on page 14 to show Pos breakdown between 60V and 70V. Updated Theta JA in "Thermal Information" on page 5 for 8 Ld SOIC from 116 to 108. Updated "Package Outline Drawing" on page 21. Changed Note 1 "1982" to "1994".
November 11, 2011	FN7786.1	Added 10 to "Pin Count" for ISL32490E, ISL32493E, ISL32496E in the Summary of Features table. Added 10 Ld MSOP option for ISL32490E, ISL32493E, ISL32496E in the "Ordering Information" table. Added 10 Ld MSOP pinout to "Pin Configurations" for ISL32490E, ISL32493E, ISL32496E. Added 10 Ld Pin # column in the "Pin Description" table. Added "(SOIC pin numbers shown)" in the "Typical Operating Circuits". Added 10 Ld MSOP information in the "Thermal Resistance" section. Added 10 Ld MSOP package outline drawing. M8.118 on page 18- Corrected lead width dimension in side view 1 from "0.25 - 0.036" to "0.25 - 0.36" M8.15 on page 21- In Typical Recommended Land Pattern, changed the following: 2.41(0.095) to 2.20(0.087) 0.76 (0.030) to 0.60(0.023) 0.200 to 5.20(0.205)
January 18, 2011	FN7786.0	Initial Release

## About Intersil

Intersil Corporation is a leading provider of innovative power management and precision analog solutions. The company's products address some of the largest markets within the industrial and infrastructure, mobile computing and high-end consumer markets.

For the most updated datasheet, application notes, related documentation and related parts, please see the respective product information page found at [www.intersil.com](http://www.intersil.com).

You may report errors or suggestions for improving this datasheet by visiting [www.intersil.com/ask](http://www.intersil.com/ask).

Reliability reports are also available from our website at [www.intersil.com/support](http://www.intersil.com/support)

For additional products, see [www.intersil.com/en/products.html](http://www.intersil.com/en/products.html)

Intersil products are manufactured, assembled and tested utilizing ISO9001 quality systems as noted in the quality certifications found at [www.intersil.com/en/support/qualandreliability.html](http://www.intersil.com/en/support/qualandreliability.html)

*Intersil products are sold by description only. Intersil Corporation reserves the right to make changes in circuit design, software and/or specifications at any time without notice. Accordingly, the reader is cautioned to verify that data sheets are current before placing orders. Information furnished by Intersil is believed to be accurate and reliable. However, no responsibility is assumed by Intersil or its subsidiaries for its use; nor for any infringements of patents or other rights of third parties which may result from its use. No license is granted by implication or otherwise under any patent or patent rights of Intersil or its subsidiaries.*

For information regarding Intersil Corporation and its products, see [www.intersil.com](http://www.intersil.com)

# Package Outline Drawing

M8.118

8 LEAD MINI SMALL OUTLINE PLASTIC PACKAGE

Rev 4, 7/11

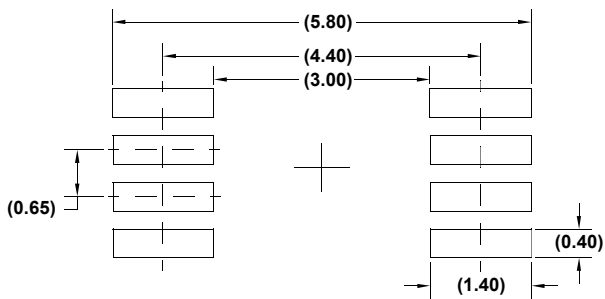
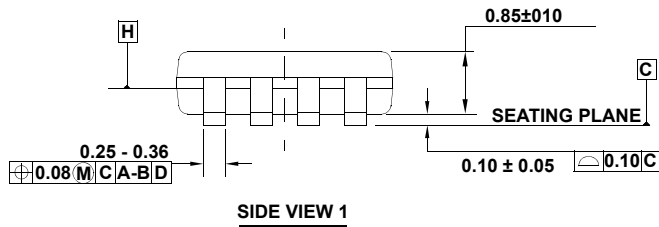
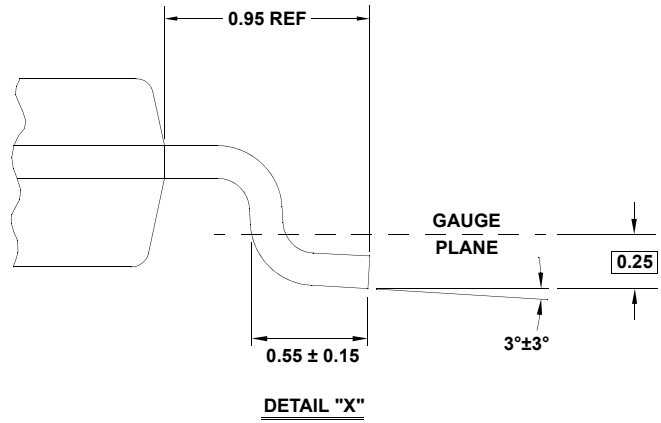
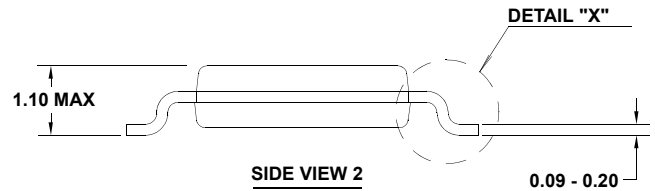
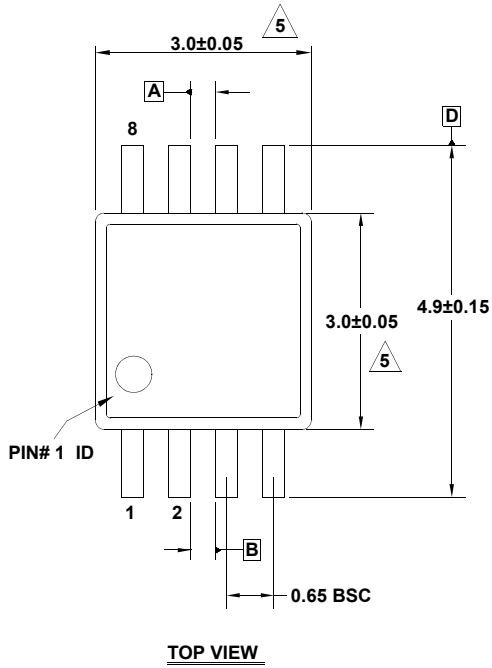

**NOTES:**

1. Dimensions are in millimeters.
2. Dimensioning and tolerancing conform to JEDEC MO-187-AA and AMSEY14.5m-1994.
3. Plastic or metal protrusions of 0.15mm max per side are not included.
4. Plastic interlead protrusions of 0.15mm max per side are not included.
5. Dimensions are measured at Datum Plane "H".
6. Dimensions in ( ) are for reference only.

# Package Outline Drawing

## M10.118

10 LEAD MINI SMALL OUTLINE PLASTIC PACKAGE

Rev 1, 4/12

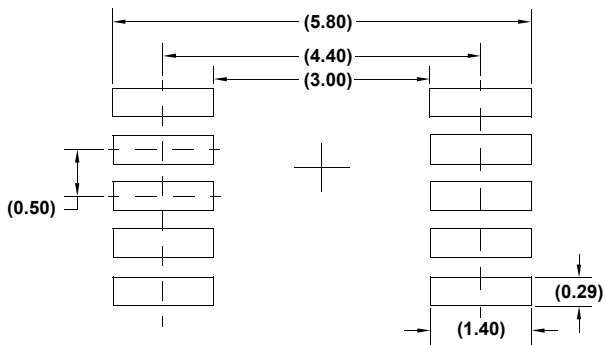
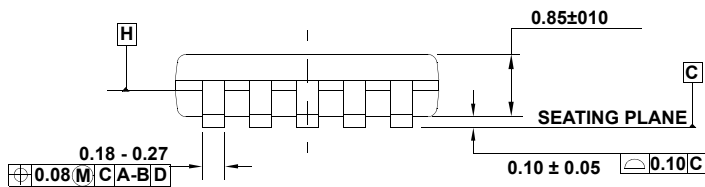
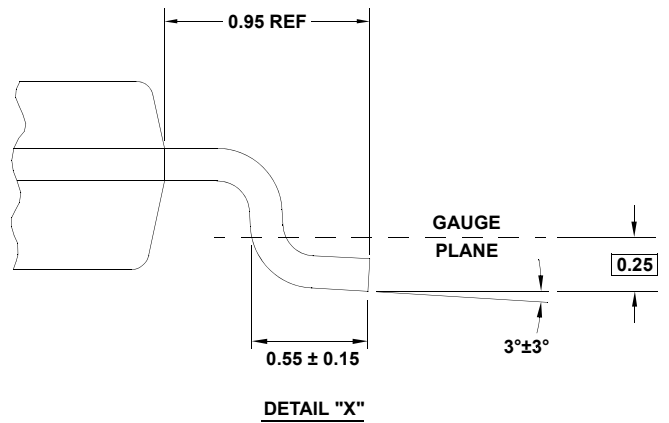
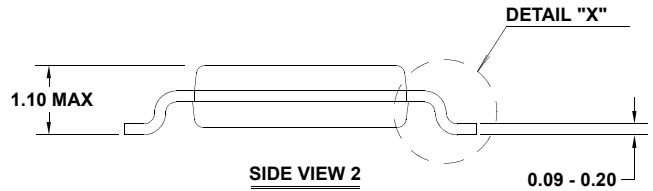
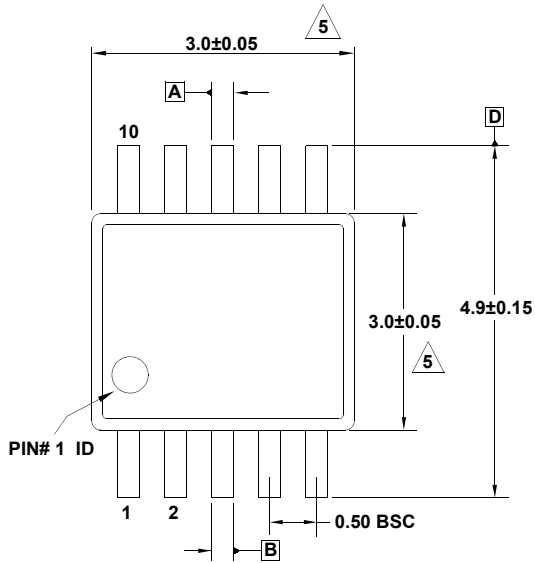

NOTES:

1. Dimensions are in millimeters.
2. Dimensioning and tolerancing conform to JEDEC MO-187-BA and AMSEY14.5m-1994.
3. Plastic or metal protrusions of 0.15mm max per side are not included.
4. Plastic interlead protrusions of 0.15mm max per side are not included.

5. Dimensions are measured at Datum Plane "H".

6. Dimensions in ( ) are for reference only.

## Package Outline Drawing

### M14.15

14 LEAD NARROW BODY SMALL OUTLINE PLASTIC PACKAGE

Rev 1, 10/09

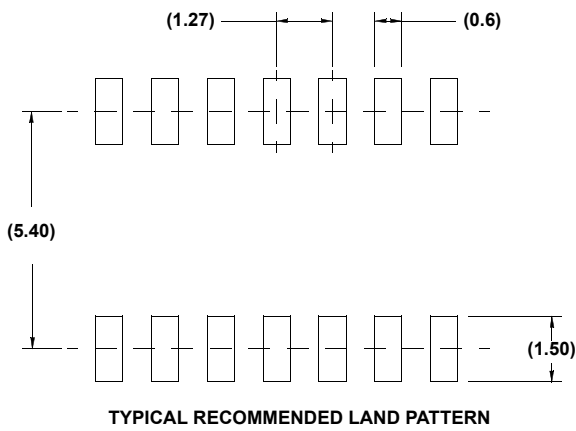
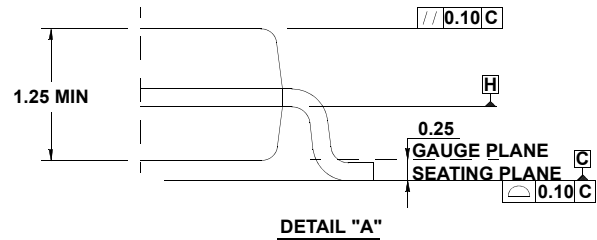
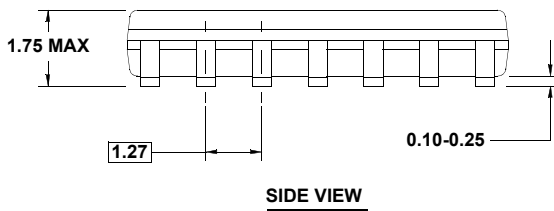
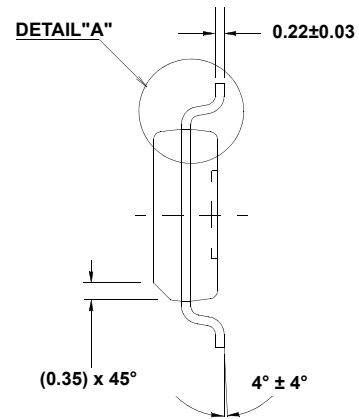
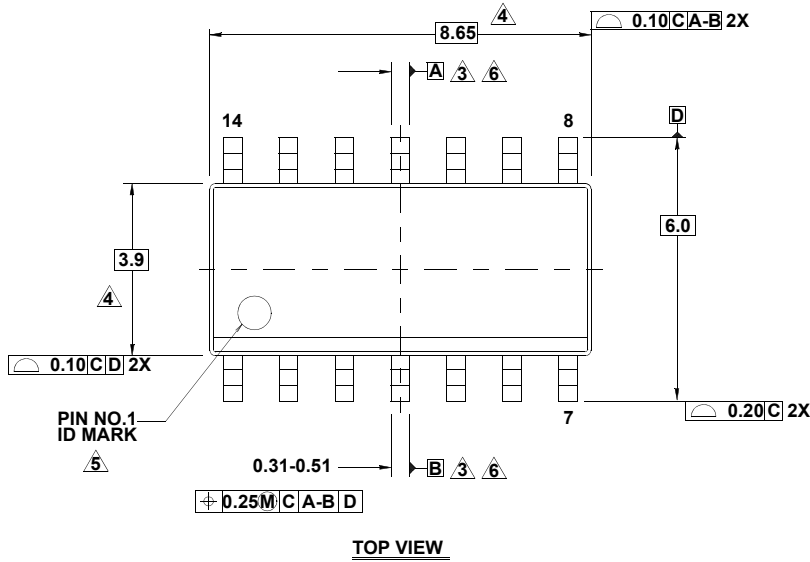

#### NOTES:

1. Dimensions are in millimeters.  
Dimensions in ( ) for Reference Only.
2. Dimensioning and tolerancing conform to AMSEY14.5m-1994.
3. Datums A and B to be determined at Datum H.
4. Dimension does not include interlead flash or protrusions.  
Interlead flash or protrusions shall not exceed 0.25mm per side.
5. The pin #1 identifier may be either a mold or mark feature.
6. Does not include dambar protrusion. Allowable dambar protrusion shall be 0.10mm total in excess of lead width at maximum condition.
7. Reference to JEDEC MS-012-AB.

# Package Outline Drawing

## M8.15

8 LEAD NARROW BODY SMALL OUTLINE PLASTIC PACKAGE

Rev 4, 1/12

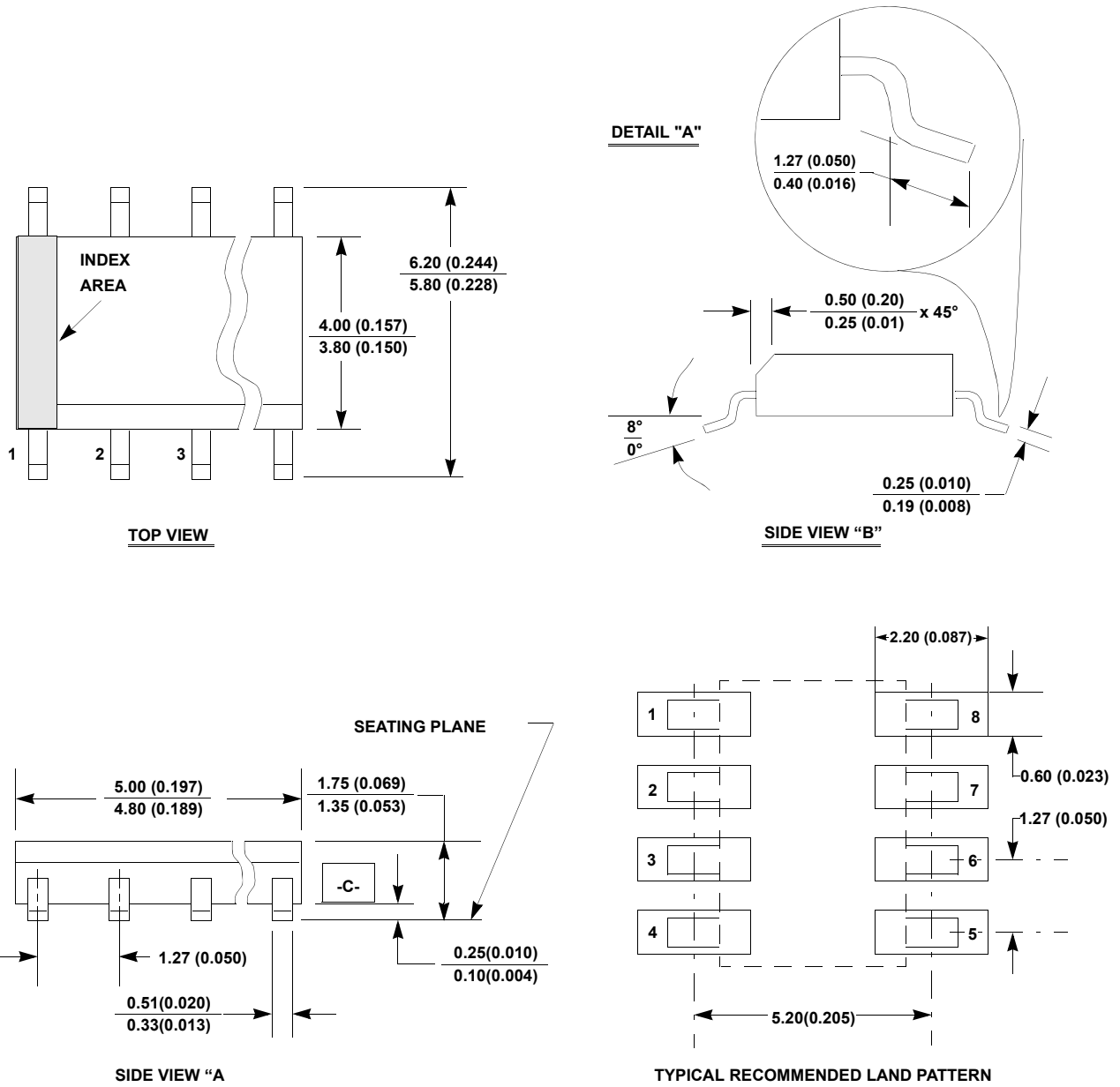

**NOTES:**

1. Dimensioning and tolerancing per ANSI Y14.5M-1994.
2. Package length does not include mold flash, protrusions or gate burrs. Mold flash, protrusion and gate burrs shall not exceed 0.15mm (0.006 inch) per side.
3. Package width does not include interlead flash or protrusions. Interlead flash and protrusions shall not exceed 0.25mm (0.010 inch) per side.
4. The chamfer on the body is optional. If it is not present, a visual index feature must be located within the crosshatched area.
5. Terminal numbers are shown for reference only.
6. The lead width as measured 0.36mm (0.014 inch) or greater above the seating plane, shall not exceed a maximum value of 0.61mm (0.024 inch).
7. Controlling dimension: MILLIMETER. Converted inch dimensions are not necessarily exact.
8. This outline conforms to JEDEC publication MS-012-AA ISSUE C.

# Mouser Electronics

Authorized Distributor

Click to View Pricing, Inventory, Delivery & Lifecycle Information:

## Intersil:

[ISL32490EIBZ](#) [ISL32490EIBZ-T](#) [ISL32490EIBZ-T7A](#) [ISL32490EIUZ-T7A](#) [ISL32492EIBZ](#) [ISL32492EIBZ-T](#)  
[ISL32492EIBZ-T7A](#) [ISL32492EIUZ](#) [ISL32492EIUZ-T](#) [ISL32492EIUZ-T7A](#) [ISL32493EIBZ](#) [ISL32493EIBZ-T](#)  
[ISL32493EIBZ-T7A](#) [ISL32493EIUZ-T7A](#) [ISL32495EIBZ](#) [ISL32495EIBZ-T](#) [ISL32495EIBZ-T7A](#) [ISL32495EIUZ](#)  
[ISL32495EIUZ-T](#) [ISL32495EIUZ-T7A](#) [ISL32496EIBZ](#) [ISL32496EIBZ-T](#) [ISL32496EIBZ-T7A](#) [ISL32496EIUZ-T7A](#)  
[ISL32498EIBZ](#) [ISL32498EIBZ-T](#) [ISL32498EIBZ-T7A](#) [ISL32498EIUZ](#) [ISL32498EIUZ-T](#) [ISL32498EIUZ-T7A](#)  
[ISL32493EIUZ](#) [ISL32496EIUZ-T](#) [ISL32496EIUZ](#) [ISL32490EIUZ](#) [ISL32490EIUZ-T](#) [ISL32493EIUZ-T](#)