

**MG06600WB-BN4MM**

RoHS

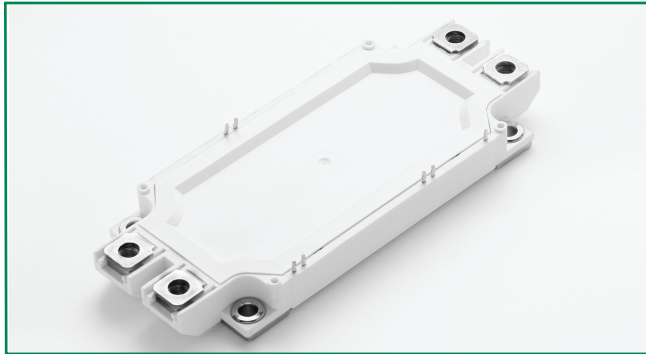

### Features

- High short circuit capability, self limiting short circuit current
- $V_{CE(sat)}$  with positive temperature coefficient
- Fast switching and short tail current
- Free wheeling diodes with fast and soft reverse recovery
- Low switching losses

### Applications

- High frequency switching application
- Medical applications
- Motion/servo control supplies
- UPS systems

### Module Characteristics ( $T_J = 25^\circ\text{C}$ , unless otherwise specified)

Symbol	Parameters	Test Conditions	Min	Typ	Max	Unit
$T_{Jmax}$	Max. Junction Temperature				175	$^\circ\text{C}$
$T_{Jop}$	Operating Temperature		-40		150	$^\circ\text{C}$
$T_{stg}$	Storage Temperature		-40		125	$^\circ\text{C}$
$V_{isol}$	Insulation Test Voltage	AC, t=1min		3000		V
CTI	Comparative Tracking Index		250			
Torque	Module-to-Sink	Recommended (M5)	2.5		5	N-m
Torque	Module Electrodes	Recommended (M6)	3		5	N-m
Weight				350		g

### Absolute Maximum Ratings ( $T_J = 25^\circ\text{C}$ , unless otherwise specified)

Symbol	Parameters	Test Conditions	Values	Unit
<b>IGBT</b>				
$V_{CES}$	Collector - Emitter Voltage	$T_J=25^\circ\text{C}$	600	V
$V_{GES}$	Gate - Emitter Voltage		$\pm 20$	V
$I_C$	DC Collector Current	$T_C=25^\circ\text{C}$	700	A
		$T_C=50^\circ\text{C}$	600	A
$I_{CM}$	Repetitive Peak Collector Current	$t_p=1\text{ms}$	1200	A
$P_{tot}$	Power Dissipation Per IGBT		1500	W
<b>Diode</b>				
$V_{RRM}$	Repetitive Reverse Voltage	$T_J=25^\circ\text{C}$	600	V
$I_{F(AV)}$	Average Forward Current	$T_C=25^\circ\text{C}$	700	A
		$T_C=50^\circ\text{C}$	600	A
$I_{FRM}$	Repetitive Peak Forward Current	$t_p=1\text{ms}$	1200	A
$I^2t$		$T_J=125^\circ\text{C}$ , t=10ms, $V_R=0\text{V}$	17000	$\text{A}^2\text{s}$

### Electrical and Thermal Specifications ( $T_J = 25^\circ\text{C}$ , unless otherwise specified)

Symbol	Parameters	Test Conditions	Min	Typ	Max	Unit
<b>IGBT</b>						
$V_{GE(th)}$	Gate - Emitter Threshold Voltage	$V_{CE}=V_{GE}, I_C=9.6\text{mA}$	4.9	5.8	6.5	V
$V_{CE(sat)}$	Collector - Emitter	$I_C=600\text{A}, V_{GE}=15\text{V}, T_J=25^\circ\text{C}$		1.45		V
	Saturation Voltage	$I_C=600\text{A}, V_{GE}=15\text{V}, T_J=125^\circ\text{C}$		1.6		V
$I_{ICES}$	Collector Leakage Current	$V_{CE}=600\text{V}, V_{GE}=0\text{V}, T_J=25^\circ\text{C}$			1	mA
		$V_{CE}=600\text{V}, V_{GE}=0\text{V}, T_J=125^\circ\text{C}$			5	mA
$I_{GES}$	Gate Leakage Current	$V_{CE}=0\text{V}, V_{GE}=\pm 15\text{V}, T_J=125^\circ\text{C}$	-400		400	nA
$R_{Gint}$	Integrated Gate Resistor			0.68		$\Omega$
$Q_{ge}$	Gate Charge	$V_{CE}=300\text{V}, I_C=600\text{A}, V_{GE}=\pm 15\text{V}$		6.5		$\mu\text{C}$
$C_{ies}$	Input Capacitance	$V_{CE}=25\text{V}, V_{GE}=0\text{V}, f=1\text{MHz}$		39		nF
$C_{res}$	Reverse Transfer Capacitance				1.15	
$t_{d(on)}$	Turn - on Delay Time	$V_{CC}=300\text{V}$ $I_C=600\text{A}$ $R_G=2.4\Omega$ $V_{GE}=\pm 15\text{V}$ Inductive Load	$T_J=25^\circ\text{C}$		100	ns
			$T_J=125^\circ\text{C}$		110	ns
$t_r$	Rise Time		$T_J=25^\circ\text{C}$		90	ns
			$T_J=125^\circ\text{C}$		95	ns
$t_{d(off)}$	Turn - off Delay Time		$T_J=25^\circ\text{C}$		670	ns
			$T_J=125^\circ\text{C}$		710	ns
$t_f$	Fall Time		$T_J=25^\circ\text{C}$		70	ns
			$T_J=125^\circ\text{C}$		75	ns
$E_{on}$	Turn - on Energy		$T_J=25^\circ\text{C}$		8.9	mJ
			$T_J=125^\circ\text{C}$		9.9	mJ
$E_{off}$	Turn - off Energy	$T_J=25^\circ\text{C}$		21.5	mJ	
		$T_J=125^\circ\text{C}$		25	mJ	
$I_{SC}$	Short Circuit Current	$t_{psc}\leq 6\mu\text{s}, V_{GE}=15\text{V}; T_J=125^\circ\text{C}, V_{CC}=360\text{V}$		3000		A
$R_{thJC}$	Junction-to-Case Thermal Resistance (Per IGBT)				0.10	K/W
<b>Diode</b>						
$V_F$	Forward Voltage	$I_F=600\text{A}, V_{GE}=0\text{V}, T_J=25^\circ\text{C}$		1.55		V
		$I_F=600\text{A}, V_{GE}=0\text{V}, T_J=125^\circ\text{C}$		1.5		V
$t_{RR}$	Reverse Recovery Time	$I_F=600\text{A}, V_R=300\text{V}$ $di_F/dt=-6000\text{A}/\mu\text{s}$ $T_J=125^\circ\text{C}$		400		ns
$I_{RRM}$	Max. Reverse Recovery Current			300		A
$E_{rec}$	Reverse Recovery Energy				9.3	
$R_{thJCD}$	Junction-to-Case Thermal Resistance (Per Diode)				0.16	K/W

### NTC Characteristics ( $T_J = 25^\circ\text{C}$ , unless otherwise specified)

Symbol	Parameters	Test Conditions	Min	Typ	Max	Unit
$R_{25}$	Resistance	$T_c=25^\circ\text{C}$		5		K $\Omega$
$B_{25/50}$				3375		K

**Figure 1: Typical Output Characteristics for IGBT Inverter**

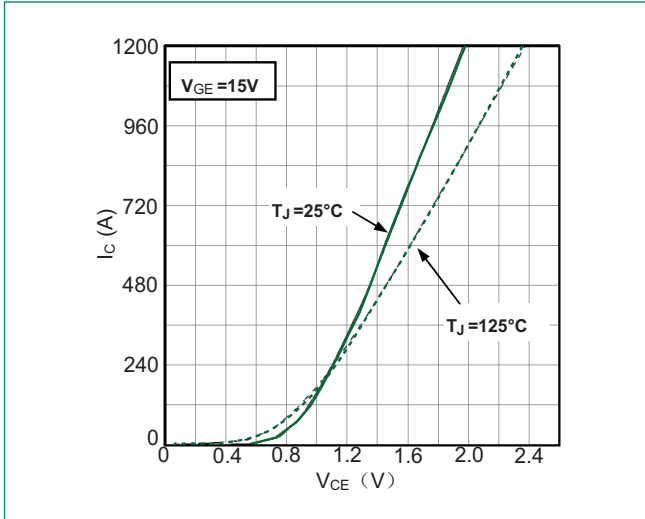

**Figure 2: Typical Output Characteristics for IGBT Inverter**

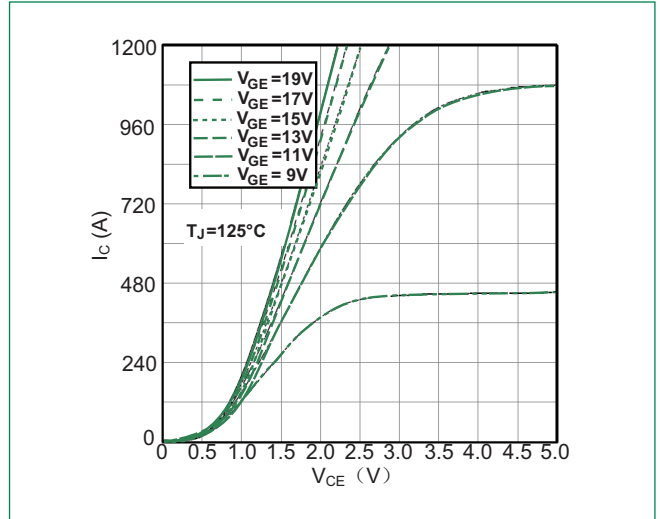

**Figure 3: Typical Transfer Characteristics for IGBT Inverter**

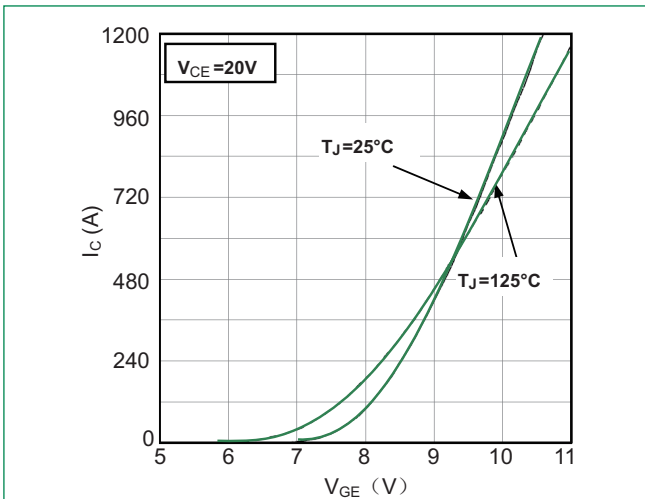

**Figure 4: Switching Energy vs. Gate Resistor for IGBT Inverter**

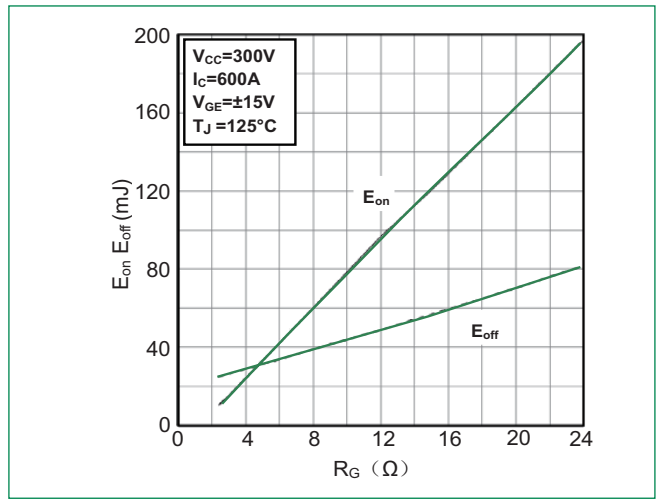

**Figure 5: Switching Energy vs. Collector Current for IGBT Inverter**

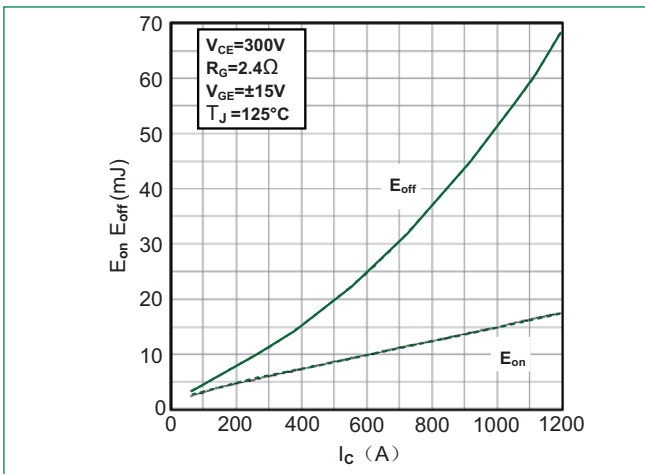

**Figure 6: Reverse Biased Safe Operating Area for IGBT Inverter**

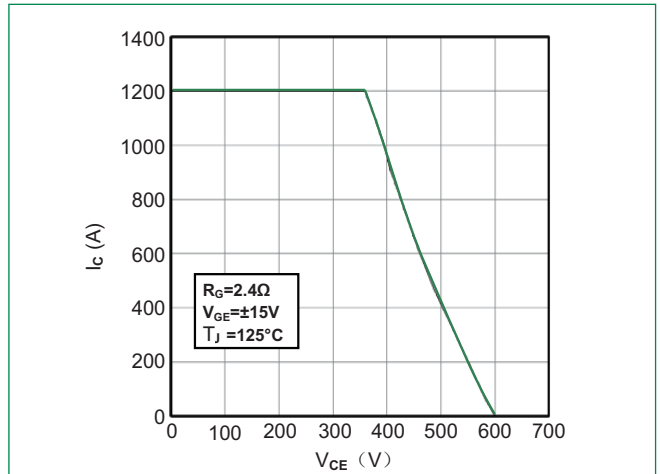

**Figure 7: Diode Forward Characteristics for Diode Inverter**

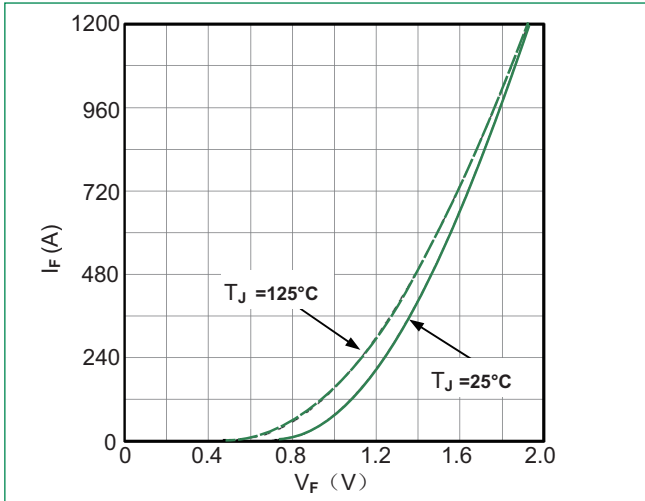

**Figure 8: Switching Energy vs. Gate Resistort for Diode Inverter**

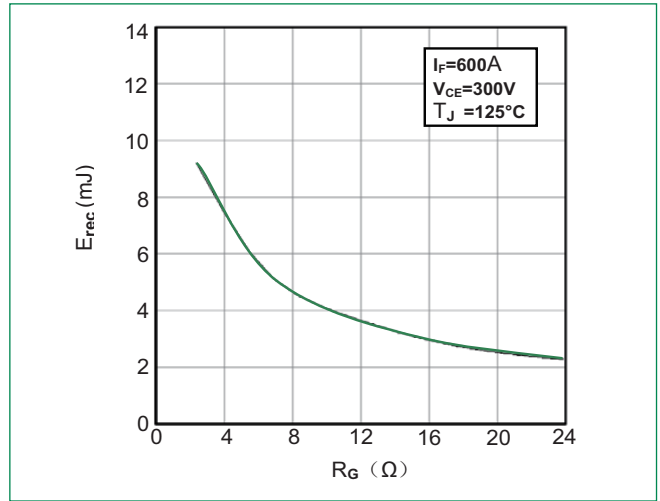

**Figure 9: Transient Thermal Impedance of Diode and IGBT Inverter**

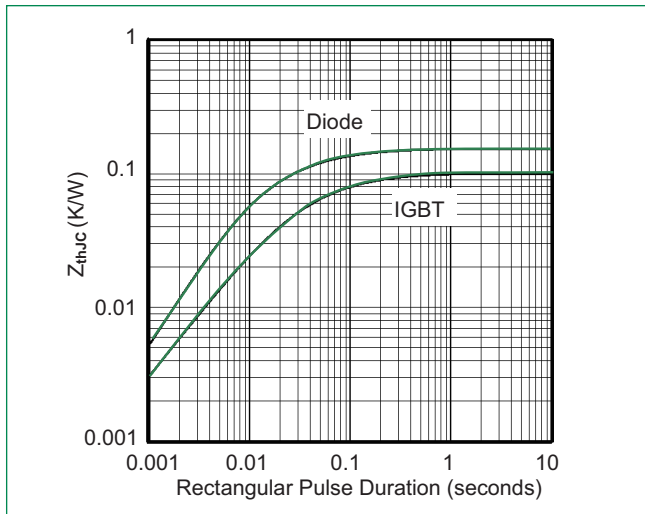

**Figure 10: NTC Characteristics**

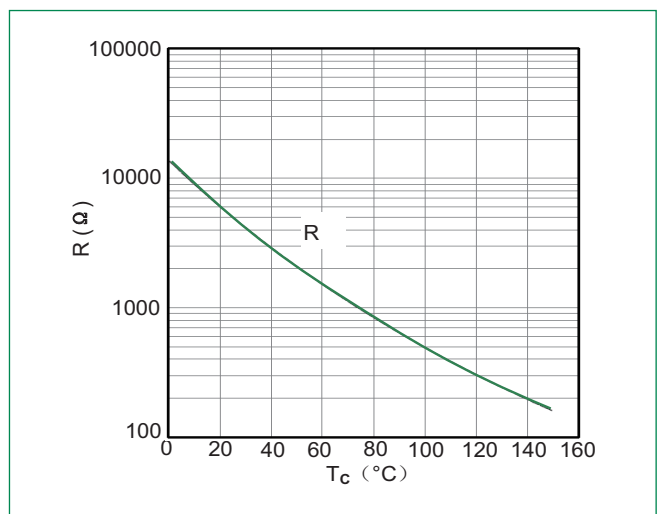

**Circuit Diagram**

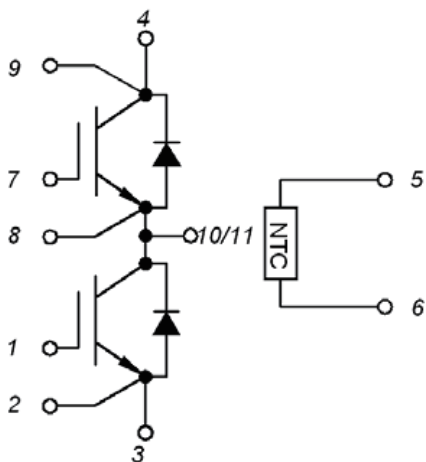

### Dimensions-Package WB



The foot pins are in gold / nickel coating

### Packing Options

Part Number	Marking	Weight	Packing Mode	M.O.Q
MG06600WB-BN4MM	MG06600WB-BN4MM	350g	Bulk Pack	60

### Part Numbering System

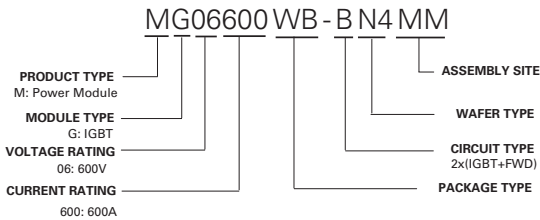

### Part Marking System

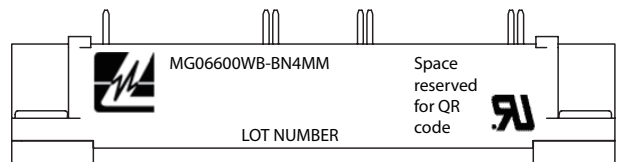

# Mouser Electronics

Authorized Distributor

Click to View Pricing, Inventory, Delivery & Lifecycle Information:

[Littelfuse:](#)

[MG06600WB-BN4MM](#)