

General Description

The MIC5207 is an efficient linear voltage regulator with ultra-low-noise output, very low dropout voltage (typically 17mV at light loads and 165mV at 150mA), and very low ground current (720 μ A at 100mA output). The MIC5207 offers better than 3% initial accuracy.

Designed especially for hand-held, battery-powered devices, the MIC5207 includes a CMOS or TTL compatible enable/shutdown control input. When in shutdown, power consumption drops nearly to zero.

Key MIC5207 features include a reference bypass pin to improve its already low-noise performance, reversed-battery protection, current limiting, and over temperature shutdown.

The MIC5207 is available in fixed and adjustable output voltage versions in a small SOT-23-5 package. Contact Micrel for details.

For low-dropout regulators that are stable with ceramic output capacitors, see the μ Cap MIC5245/6/7 family.

Datasheets and support documentation are available on Micrel's web site at: www.micrel.com.

Features

- Output voltage range: 1.8V – 15V
- Ultra-low-noise output
- High output voltage accuracy
- Guaranteed 180mA output
- Low quiescent current
- Low dropout voltage
- Extremely tight load and line regulation
- Very low temperature coefficient
- Current and thermal limiting
- Reversed-battery protection
- "Zero" off-mode current
- Logic-controlled electronic enable

Applications

- Cellular telephones
- Laptop, notebook, and palmtop computers
- Battery-powered equipment
- PCMCIA VCC and VPP regulation/switching
- Consumer/personal electronics
- SMPS post-regulator/dc-to-dc modules
- High-efficiency linear power supplies

Typical Application

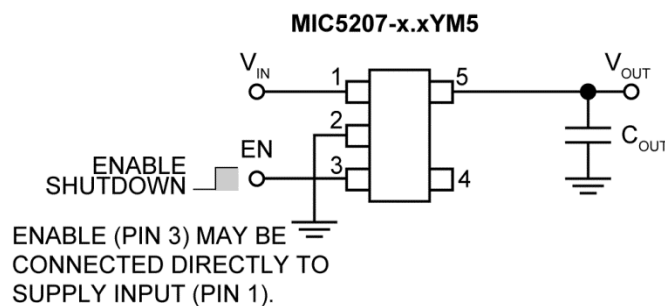

Battery-Powered Regulator Application

Ordering Information

Part Number	Marking ⁽²⁾	Voltage ⁽¹⁾	Junction Temp. Range	Package	Lead Finish
MIC5207-1.8YD5	<u>NE</u> 18	1.8V	0° to +125°C	5-Pin Thin SOT-23	Pb-Free
MIC5207YM5	<u>LE</u> AA	Adj. (2.5–15.0V)	–40° to +125°C	5-Pin SOT-23	Pb-Free
		Adj. (1.8–2.5V)	0° to +125°C		
MIC5207-1.8YM5	<u>LE</u> 18	1.8V	0° to +125°C	5-Pin SOT-23	Pb-Free
MIC5207-2.5YM5	<u>LE</u> 25	2.5V	–40° to +125°C	5-Pin SOT-23	Pb-Free
MIC5207-2.8YM5	<u>LE</u> 28	2.8V	–40° to +125°C	5-Pin SOT-23	Pb-Free
MIC5207-2.9YM5	<u>LE</u> 29	2.9V	–40° to +125°C	5-Pin SOT-23	Pb-Free
MIC5207-3.0YM5	<u>LE</u> 30	3.0V	–40° to +125°C	5-Pin SOT-23	Pb-Free
MIC5207-3.1YM5	<u>LE</u> 31	3.1V	–40° to +125°C	5-Pin SOT-23	Pb-Free
MIC5207-3.2YM5	<u>LE</u> 32	3.2V	–40° to +125°C	5-Pin SOT-23	Pb-Free
MIC5207-3.3YM5	<u>LE</u> 33	3.3V	–40° to +125°C	5-Pin SOT-23	Pb-Free
MIC5207-3.6YM5	<u>LE</u> 36	3.6V	–40° to +125°C	5-Pin SOT-23	Pb-Free
MIC5207-3.8YM5	<u>LE</u> 38	3.8V	–40° to +125°C	5-Pin SOT-23	Pb-Free
MIC5207-4.0YM5	<u>LE</u> 40	4.0V	–40° to +125°C	5-Pin SOT-23	Pb-Free
MIC5207-5.0YM5	<u>LE</u> 50	5.0V	–40° to +125°C	5-Pin SOT-23	Pb-Free

Note:

1. Other voltages available. Contact Micrel for details.
2. Under bar () symbol may not be to scale.

Pin Configuration

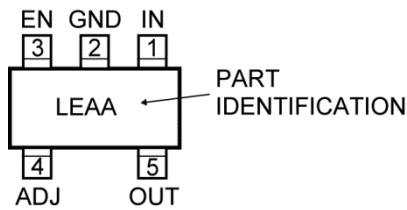

MIC5207YM5 (M5)
(Adjustable Voltage)

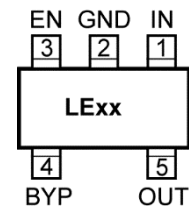

MIC5207-x.xYM5 (M5)
MIC5207-x.xYD5 (D5)
(Fixed Voltage)

Pin Description

Pin Number SOT-23-5	Pin Name	Pin Name
1	IN	Supply Input.
2	GND	Ground.
3	EN	Enable/Shutdown (Input): CMOS compatible input. Logic high = enable, logic low = shutdown. Do not leave floating.
4 (fixed)	BYP	Reference Bypass: Connect external 470pF capacitor to GND to reduce output noise. May be left open. For 1.8V or 2.5V operation, see "Applications Information".
4 (adj.)	ADJ	Adjust (Input): Adjustable regulator feedback input. Connect to resistor voltage divider.
5	OUT	Regulator Output.

Absolute Maximum Ratings⁽³⁾

Supply Input Voltage (V_{IN})	-20V to +20V
Enable Input Voltage (V_{EN})	-20V to +20V
Power Dissipation (P_D)	Internally Limited ⁽⁵⁾
Lead Temperature (soldering, 5 sec)	260°C
Junction Temperature (T_J)		
All except 1.8V	-40°C to +125°C
1.8V ONLY	0°C to +125°C
Storage Temperature (T_S)	-65°C to +150°C

Operating Ratings⁽⁴⁾

Supply Input Voltage (V_{IN})	+2.5V to +16V
Adjustable Output Voltage (V_{OUT}) Range	1.8V to 15V
Enable Input Voltage (V_{EN})	0V to V_{IN}
Junction Temperature (T_J)		
$2.5 \leq V_{OUT} \leq 15V$	-40°C to +125°C
$1.8V \leq V_{OUT} < 2.5V$	0°C to +125°C
Thermal Resistance (θ_{JA})	Note 5

Electrical Characteristics

$V_{IN} = V_{OUT} + 1V$; $I_L = 100\mu A$; $C_L = 1.0\mu F$; $V_{EN} \geq 2.0V$; $T_J = 25^\circ C$, **bold** values indicate $-40^\circ C < T_J < +125^\circ C$ except $0^\circ C < T_J < +125^\circ C$ for 1.8V, unless noted.

Symbol	Parameter	Condition	Min	Typ	Max	Units
V_O	Output Voltage Accuracy	Variation from nominal V_{OUT}	-3 -4		3 4	% %
$\Delta V_O/\Delta T$	Output Voltage Temperature Coefficient	Note 6		40		ppm/°C
$\Delta V_O/V_O$	Line Regulation	$V_{IN} = V_{OUT} + 1V$ to 16V		0.005	0.05 0.10	%/V %/V
$\Delta V_O/V_O$	Load Regulation	$I_L = 0.1mA$ to 150mA, Note 7		0.05	0.5 0.7	% %
$V_{IN} - V_O$	Dropout Voltage, Note 8	$I_L = 100\mu A$ $I_L = 50mA$ $I_L = 100mA$ $I_L = 150mA$		17 115 140 165	60 80 175 250 280 325 300 400	mV mV mV mV mV mV
I_{GND}	Quiescent Current	$V_{EN} \leq 0.4V$ (shutdown) $V_{EN} \leq 0.18V$ (shutdown)		0.01	1 5	μA μA

Notes:

- Exceeding the absolute maximum rating may damage the device.
- The device is not guaranteed to function outside its operating rating.
- The maximum allowable power dissipation at any T_A (ambient temperature) is $P_D(max) = (T_J(max) - T_A) / \theta_{JA}$. Exceeding the maximum allowable power dissipation will cause excessive die temperature, and the regulator will go into thermal shutdown. The θ_{JA} of the SOT-23-5 (M5) is 235°C/W soldered on a PC board (see "Thermal Considerations" for further details).
- Output voltage temperature coefficient is defined as the worst case voltage change divided by the total temperature range.
- Regulation is measured at constant junction temperature using low duty cycle pulse testing. Parts are tested for load regulation in the load range from 0.1mA to 180mA. Changes in output voltage due to heating effects are covered by the thermal regulation specification.
- Dropout Voltage is defined as the input to output differential at which the output voltage drops 2% below its nominal value measured at 1V differential.

Electrical Characteristics (Continued)

$V_{IN} = V_{OUT} + 1V$; $I_L = 100\mu A$; $C_L = 1.0\mu F$; $V_{EN} \geq 2.0V$; $T_J = 25^\circ C$, bold values indicate $-40^\circ C < T_J < +125^\circ C$ except $0^\circ C < T_J < +125^\circ C$ for 1.8V, unless noted.

Symbol	Parameter	Condition	Min	Typ	Max	Units
I_{GND}	Ground Pin Current, Note 9	$V_{EN} \geq 2.0V$, $I_L = 100\mu A$ $I_L = 50mA$ $I_L = 100mA$ $I_L = 150mA$		80 350 720 1800	130 170 650 900 1100 2000 2500 3000	μA μA μA μA μA μA μA
PSRR	Ripple Rejection			75		dB
I_{LIMIT}	Current Limit	$V_{OUT} = 0V$		320	500	mA
$\Delta V_O/\Delta P_D$	Thermal Regulation	Note 10		0.05		%/W
e_{no}	Output Noise	$I_L = 50mA$, $C_L = 2.2\mu F$, 470pF from BYP to GND		260		$nV\sqrt{Hz}$
Enable Input						
V_{IL}	Enable Input Logic-Low Voltage	Regulator shutdown			0.4 0.18	V V
V_{IH}	Enable Input Logic-High Voltage	Regulator enable	2.0			V
I_{IL} I_{IH}	Enable Input Current	$V_{IL} \leq 0.4V$ $V_{IL} \leq 0.18V$ $V_{IH} \geq 2.0V$ $V_{IH} \geq 2.0V$		0.01 5	-1 -2 20 25	μA μA μA μA

Notes:

- Ground pin current is the regulator quiescent current plus pass transistor base current. The total current drawn from the supply is the sum of the load current plus the ground pin current.
- Thermal regulation is defined as the change in output voltage at a time "t" after a change in power dissipation is applied, excluding load or line regulation effects. Specifications are for a 180mA load pulse at $V_{IN} = 16V$ for $t = 10ms$.

Typical Characteristics

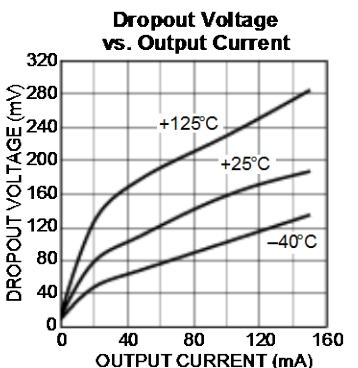
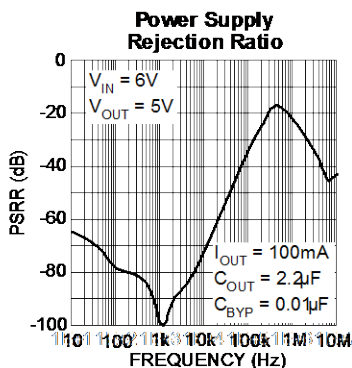
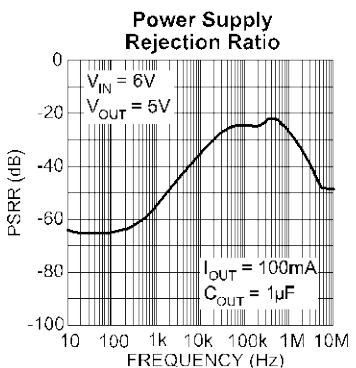
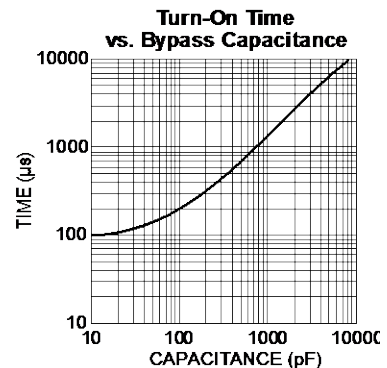
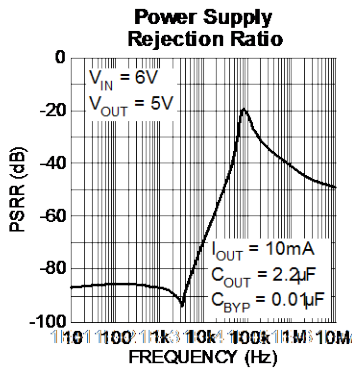
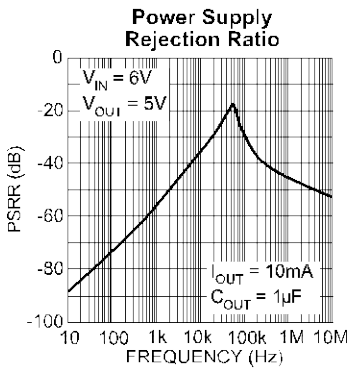
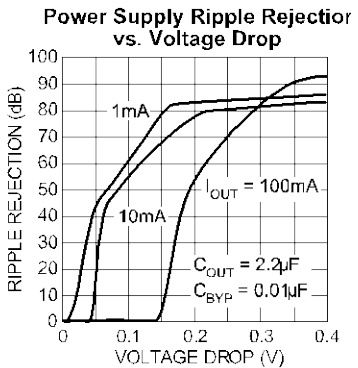
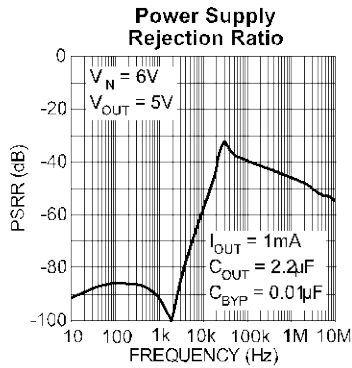
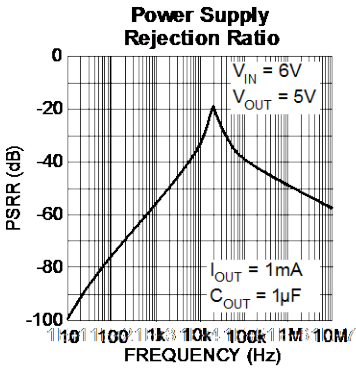
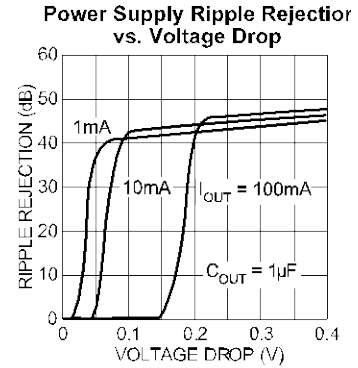
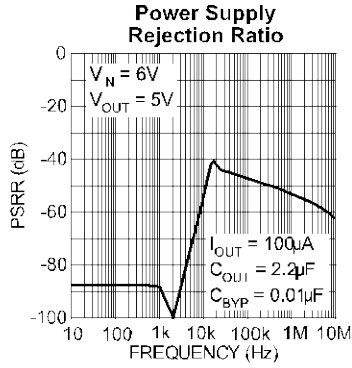
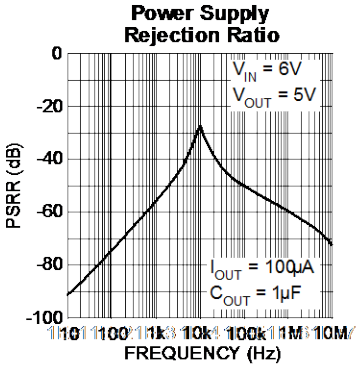

Typical Characteristics (Continued)

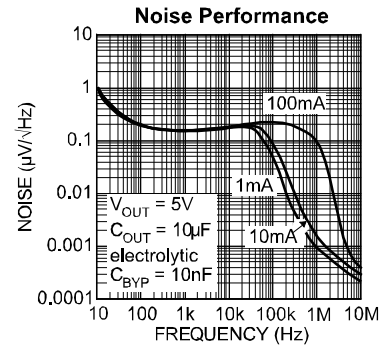
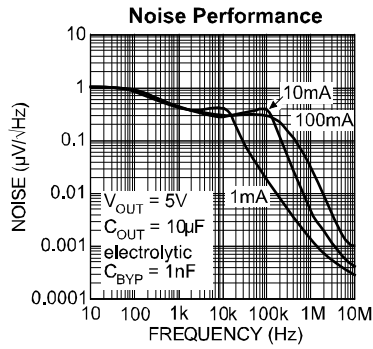
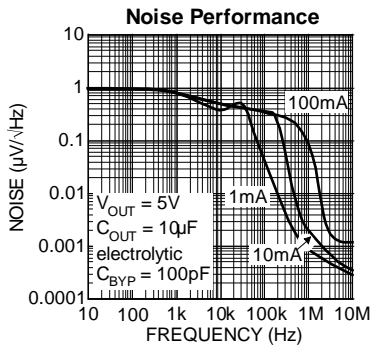
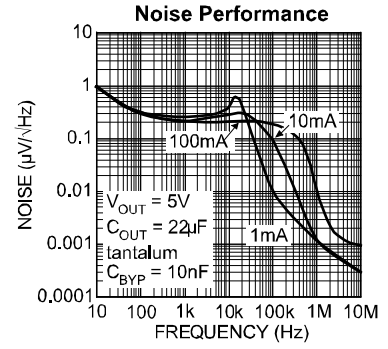
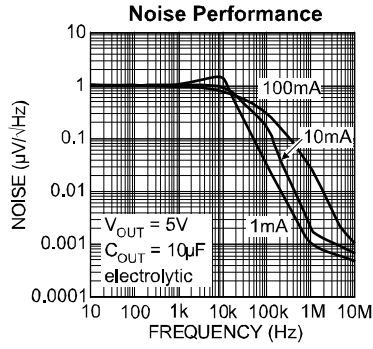
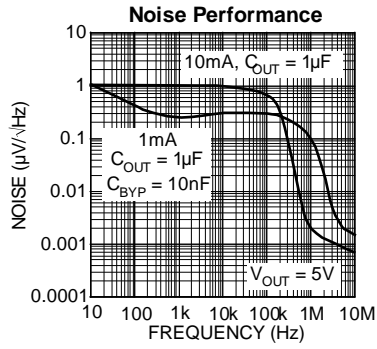

Block Diagrams

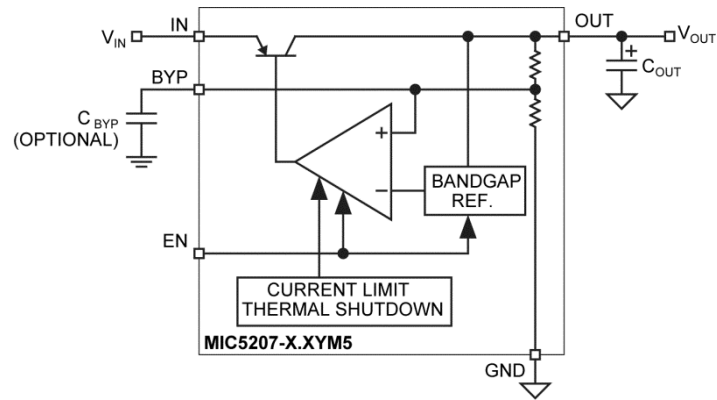

Ultra-Low-Noise Fixed Regulator

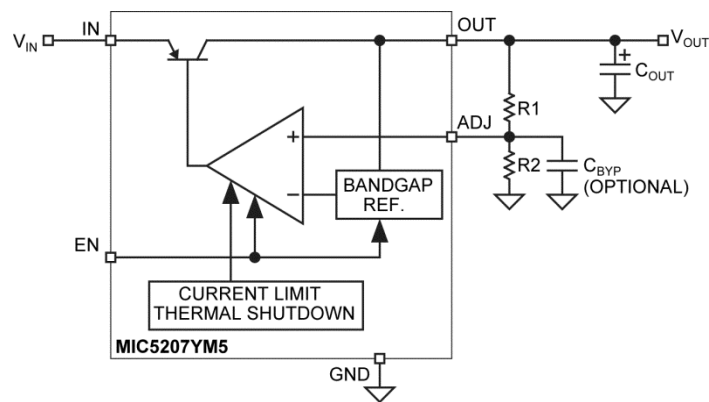

Ultra-Low-Noise Adjustable Regulator

Application Information

Enable/Shutdown

Forcing EN (enable/shutdown) high (> 2V) enables the regulator. EN is compatible with CMOS logic gates.

If the enable/shutdown feature is not required, connect EN (pin 3) to IN (supply input, pin 1). See Figure 1.

Input Capacitor

A 1 μ F capacitor should be placed from IN to GND if there is more than 10 inches of wire between the input and the ac filter capacitor or if a battery is used as the input.

Reference Bypass Capacitor

BYP (reference bypass) is connected to the internal voltage reference. A 470pF capacitor (C_{BYP}) connected from BYP to GND quiets this reference, providing a significant reduction in output noise. C_{BYP} reduces the regulator phase margin; when using C_{BYP} , output capacitors of 2.2 μ F or greater are generally required to maintain stability.

The start-up speed of the MIC5207 is inversely proportional to the size of the reference bypass capacitor. Applications requiring a slow ramp-up of output voltage should consider larger values of C_{BYP} . Likewise, if rapid turn-on is necessary, consider omitting C_{BYP} .

If output noise is not a major concern, omit C_{BYP} and leave BYP open.

Output Capacitor

An output capacitor is required between OUT and GND to prevent oscillation. The minimum size of the output capacitor is dependent upon whether a reference bypass capacitor is used. 1.0 μ F minimum is recommended when C_{BYP} is not used (see Figure 2). 2.2 μ F minimum is recommended when C_{BYP} is 470pF (see Figure 1). Larger values improve the regulator's transient response. The output capacitor value may be increased without limit.

The output capacitor should have an ESR (effective series resistance) of about 5 Ω or less and a resonant frequency above 1MHz. Ultra-low-ESR (ceramic) capacitors can cause a low amplitude oscillation on the output and/or under-damped transient response. Most tantalum or aluminum electrolytic capacitors are adequate; film types will work, but are more expensive. Since many aluminum electrolytics have electrolytes that freeze at about -30°C, solid tantalums are recommended for operation below -25°C.

At lower values of output current, less output capacitance is required for output stability. The capacitor can be reduced to 0.47 μ F for current below 10mA or 0.33 μ F for currents below 1mA.

No-Load Stability

The MIC5207 will remain stable and in regulation with no load (other than the internal voltage divider) unlike many other voltage regulators. This is especially important in CMOSRAM keep-alive applications.

Thermal Considerations

The MIC5207 is designed to provide 180mA of continuous current in a very small package. Maximum power dissipation can be calculated based on the output current and the voltage drop across the part. To determine the maximum power dissipation of the package, use the junction-to-ambient thermal resistance of the device and the following basic equation shown in Equation 1:

$$P_{D(MAX)} = \frac{(T_{J(MAX)} - T_A)}{\theta_{JA}} \quad \text{Eq. 1}$$

$T_{J(max)}$ is the maximum junction temperature of the die, 125°C, and T_A is the ambient operating temperature. θ_{JA} is layout dependent; Table 1 shows examples of junction-to-ambient thermal resistance for the MIC5207.

Table 1. SOT-23-5 Thermal Resistance

Package	θ_{JA} Recommended Minimum Footprint	θ_{JA} 1" Square Copper Clad	θ_{JC}
SOT-23-5 (M5)	235°C/W	170°C/W	130°C/W

The actual power dissipation of the regulator circuit can be determined using Equation 2:

$$P_D = (V_{IN} - V_{OUT}) I_{OUT} + V_{IN} I_{GND} \quad \text{Eq. 2}$$

Substituting $P_{D(max)}$ for P_D and solving for the operating conditions that are critical to the application will give the maximum operating conditions for the regulator circuit. For example, when operating the MIC5207-3.3YM5 at room temperature with a minimum footprint layout, the maximum input voltage for a set output current can be determined with Equation 3:

$$P_{D(MAX)} = \frac{125^\circ\text{C} - 25^\circ\text{C}}{235^\circ\text{C/W}} \quad \text{Eq. 3}$$

$$P_{D(MAX)} = 425\text{mW}$$

The junction-to-ambient thermal resistance for the minimum footprint is 235°C/W, from Table 1. The maximum power dissipation must not be exceeded for proper operation. Using the output voltage of 3.3V and an output current of 150mA, the maximum input voltage can be determined. From the *Electrical Characteristics* table, the maximum ground current for 150mA output current is 3000µA or 3mA.

$$455\text{mW} = (V_{\text{IN}} - 3.3\text{V})150\text{mA} + V_{\text{IN}} \cdot 3\text{mA}$$

$$455\text{mW} = V_{\text{IN}} \cdot 150\text{mA} - 495\text{mW} + V_{\text{IN}} \cdot 3\text{mA}$$

$$920\text{mW} = V_{\text{IN}} \cdot 153\text{mA}$$

$$V_{\text{IN(MAX)}} = 6.01\text{V}$$

Therefore, a 3.3V application at 150mA of output current can accept a maximum input voltage of 6V in a SOT-23-5 package. For a full discussion of heat sinking and thermal effects on voltage regulators, refer to the Regulator Thermals section of Micrel's *Designing with Low-Dropout Voltage Regulators* handbook

Low-Voltage Operation

The MIC5207-1.8 and MIC5207-2.5 require special consideration when used in voltage-sensitive systems. They may momentarily overshoot their nominal output voltages unless appropriate output and bypass capacitor values are chosen.

During regulator power up, the pass transistor is fully saturated for a short time, while the error amplifier and voltage reference are being powered up more slowly from the output (see *Block Diagrams*). Selecting larger output and bypass capacitors allows additional time for the error amplifier and reference to turn on and prevent overshoot.

To ensure that no overshoot is present when starting up into a light load (100µA), use a 4.7µF output capacitance and 470pF bypass capacitance. This slows the turn-on enough to allow the regulator to react and keep the output voltage from exceeding its nominal value. At heavier loads, use a 10µF output capacitance and 470pF bypass capacitance. Lower values of output and bypass capacitance can be used, depending on the sensitivity of the system.

Applications that can withstand some overshoot on the output of the regulator can reduce the output capacitor and/or reduce or eliminate the bypass capacitor. Applications that are not sensitive to overshoot due to power-on reset delays can use normal output and bypass capacitor configurations.

Please note the junction temperature range of the regulator with an output less than 2.5V fixed and adjustable is 0°C to +125°C.

Fixed Regulator Applications

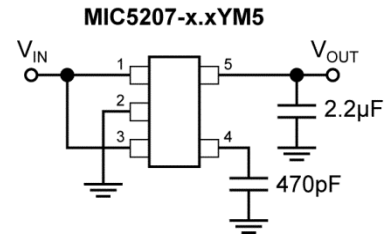

Figure 1. Ultra-Low-Noise Fixed Voltage Application

Figure 1 includes a 470pF capacitor for ultra-low-noise operation and shows EN (pin 3) connected to IN (pin 1) for an application where enable/shutdown is not required. C_{OUT} = 2.2µF minimum.

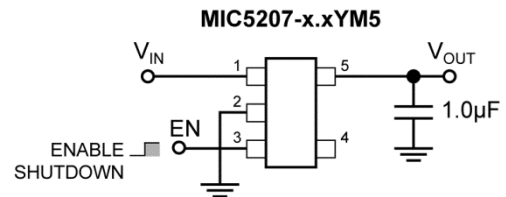

Figure 2. Low-Noise Fixed Voltage Application

Figure 2 is an example of a basic low-noise configuration. C_{OUT} = 1µF minimum.

Adjustable Regulator Applications

The MIC5207YM5 can be adjusted to a specific output voltage by using two external resistors (Figure 3). The resistors set the output voltage based on Equation 4:

$$V_{\text{OUT}} = V_{\text{REF}} \left(1 + \frac{R_2}{R_1} \right), V_{\text{REF}} = 1.242\text{V} \quad \text{Eq. 4}$$

This equation is correct due to the configuration of the bandgap reference. The bandgap voltage is relative to the output, as seen in the *Block Diagrams*. Traditional regulators normally have the reference voltage relative to ground; therefore, their equations are different from the equation for the MIC5207YM5.

Resistor values are not critical because ADJ (adjust) has a high input impedance, but for best results use resistors of 470kΩ or less. A capacitor from ADJ to ground provides greatly improved noise performance.

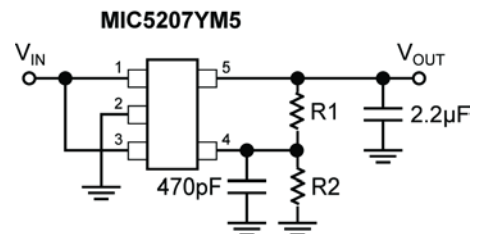

Figure 3. Ultra-Low-Noise Adjustable Voltage Application

Figure 3 includes the optional 470pF noise bypass capacitor from ADJ to GND to reduce output noise.

Dual-Supply Operation

When used in dual-supply systems where the regulator load is returned to a negative supply, the output voltage must be diode clamped to ground.

USB Application

Figure 4 shows the MIC5207-3.3YM5 in a USB application. Since the V_{BUS} supply may be greater than 10 inches from the regulator, a $1\mu\text{F}$ input capacitor is included.

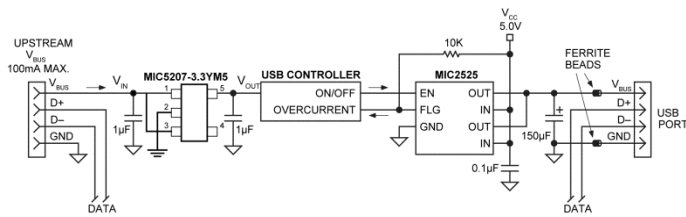
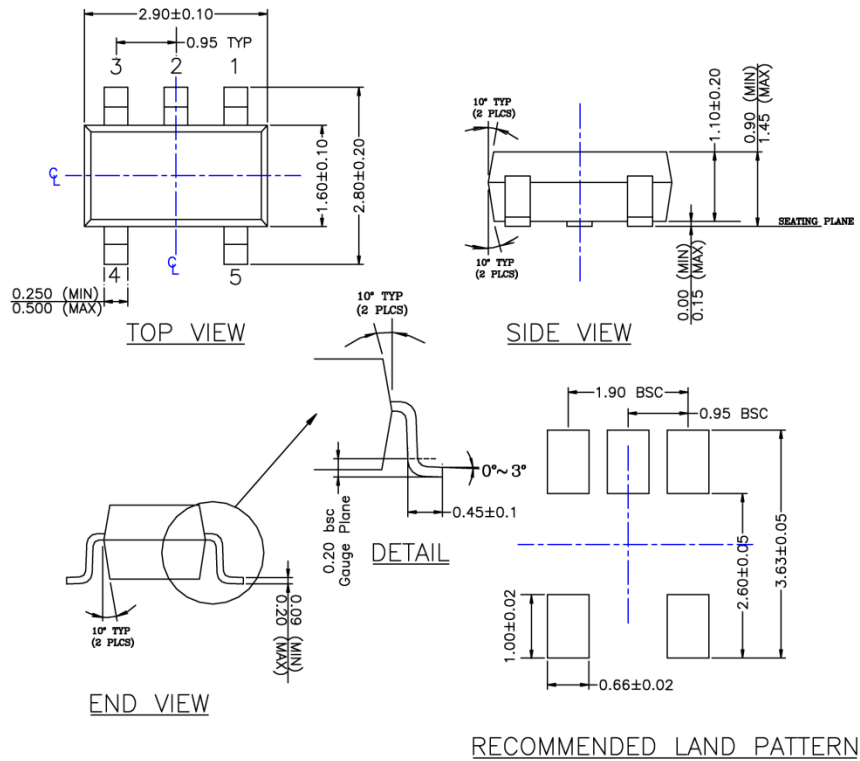

Figure 4. Single-Port Self-Powered Hub

Package Information⁽¹¹⁾



- NOTE:
1. PACKAGE OUTLINE EXCLUSIVE OF MOLD FLASH & BURR.
 2. PACKAGE OUTLINE INCLUSIVE OF SOLDER PLATING.
 3. DIMENSION AND TOLERANCE PER ANSI Y14.5M, 1982.
 4. FOOT LENGTH MEASUREMENT BASED ON GAUGE PLANE METHOD.
 5. DIE FACES UP FOR MOLD, AND FACES DOWN FOR TRIM/FORM.
 6. ALL DIMENSIONS ARE IN MILLIMETERS.

5-Pin SOT-23 (M5)

Package Information⁽¹¹⁾ (Continued)

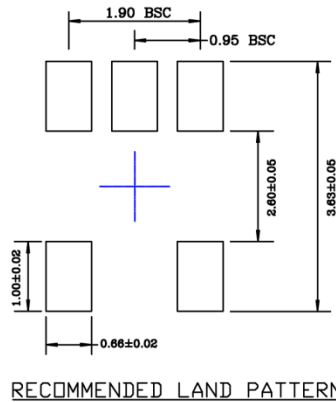
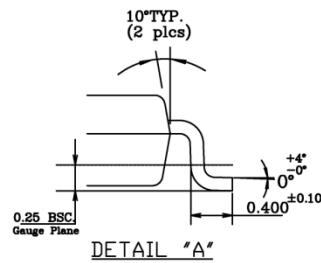
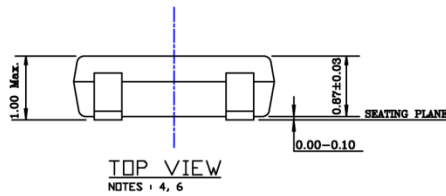
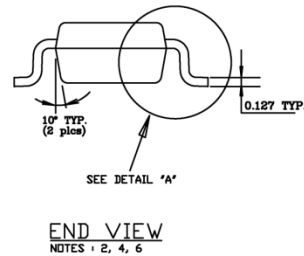
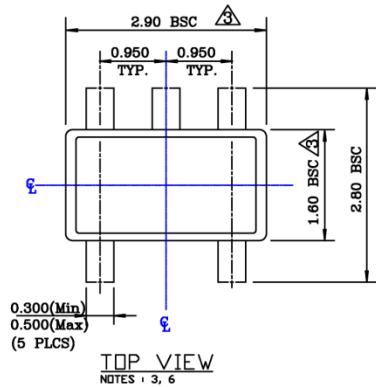

NOTE:

1. Dimensions and tolerances are as per ANSI Y14.5M, 1994.
2. Die is facing up for mold. Die is facing down for trim/form, ie. reverse trim/form.
3. Dimensions are exclusive of mold flash and gate burr.
4. The footlength measuring is based on the gauge plane method.
5. All specification comply to Jeduc Spec M0193 Issue C.
6. All dimensions are in millimeters.

5-Pin Thin SOT-23 (D5)

Note:

11. Package information is correct as of the publication date. For updates and most current information, go to www.micrel.com.

MICREL, INC. 2180 FORTUNE DRIVE SAN JOSE, CA 95131 USA
TEL +1 (408) 944-0800 FAX +1 (408) 474-1000 WEB <http://www.micrel.com>

Micrel, Inc. is a leading global manufacturer of IC solutions for the worldwide high performance linear and power, LAN, and timing & communications markets. The Company's products include advanced mixed-signal, analog & power semiconductors; high-performance communication, clock management, MEMs-based clock oscillators & crystal-less clock generators, Ethernet switches, and physical layer transceiver ICs. Company customers include leading manufacturers of enterprise, consumer, industrial, mobile, telecommunications, automotive, and computer products. Corporation headquarters and state-of-the-art wafer fabrication facilities are located in San Jose, CA, with regional sales and support offices and advanced technology design centers situated throughout the Americas, Europe, and Asia. Additionally, the Company maintains an extensive network of distributors and reps worldwide.

Micrel makes no representations or warranties with respect to the accuracy or completeness of the information furnished in this datasheet. This information is not intended as a warranty and Micrel does not assume responsibility for its use. Micrel reserves the right to change circuitry, specifications and descriptions at any time without notice. No license, whether express, implied, arising by estoppel or otherwise, to any intellectual property rights is granted by this document. Except as provided in Micrel's terms and conditions of sale for such products, Micrel assumes no liability whatsoever, and Micrel disclaims any express or implied warranty relating to the sale and/or use of Micrel products including liability or warranties relating to fitness for a particular purpose, merchantability, or infringement of any patent, copyright, or other intellectual property right.

Micrel Products are not designed or authorized for use as components in life support appliances, devices or systems where malfunction of a product can reasonably be expected to result in personal injury. Life support devices or systems are devices or systems that (a) are intended for surgical implant into the body or (b) support or sustain life, and whose failure to perform can be reasonably expected to result in a significant injury to the user. A Purchaser's use or sale of Micrel Products for use in life support appliances, devices or systems is a Purchaser's own risk and Purchaser agrees to fully indemnify Micrel for any damages resulting from such use or sale.

© 2001 Micrel, Incorporated.

Mouser Electronics

Authorized Distributor

Click to View Pricing, Inventory, Delivery & Lifecycle Information:

[Micrel:](#)

[MIC5207-3.0YM5 TR](#) [MIC5207YM5 TR](#) [MIC5207-2.5YM5 TR](#) [MIC5207-3.3YM5 TR](#) [MIC5207-5.0YM5 TR](#) [MIC5207-1.8YM5 TR](#) [MIC5207-1.8YD5 TR](#) [MIC5207-2.9YM5 TR](#) [MIC5207-2.8YM5 TR](#) [MIC5207-3.2YM5 TR](#) [MIC5207-4.0YM5 TR](#) [MIC5207-3.1YM5 TR](#)