

General Description

The MIC5253 is an efficient, CMOS voltage regulator optimized for ultra-low-noise applications. It offers 1.5% initial accuracy, extremely low dropout voltage (165mV at 100mA), and low ground current (typically 95 μ A at full load). The MIC5253 provides a very low noise output, ideal for RF applications where a clean voltage source is required. A noise bypass pin is also available for further reduction of output noise.

Designed specifically for handheld and battery-powered devices, the MIC5253 provides a TTL-logic-compatible enable pin. When disabled, power consumption drops nearly to zero.

The MIC5253 also works with low-ESR ceramic capacitors, reducing the amount of board space necessary for power applications, critical in handheld wireless devices.

Available in the Teeny™ SC-70-5 package, the MIC5253 offers a wide range of output voltages. Key features include current limit, thermal shutdown, faster transient response, and an active clamp to speed up device turn-off.

Features

- Input voltage range: 2.7V to 5.5V
- Teeny™ SC-70-5 package
- Ultra-low output noise: 30 μ V(rms)
- 100mA continuous output current, 150mA peak current
- Stability with ceramic output capacitors
- Ultralow dropout: 165mV @ 100mA
- High output accuracy:
 - 1.5% initial accuracy
 - 3.0% over temperature
- Low ground current: 95 μ A
- TTL-Logic-controlled enable input
- “Zero” off-mode current
- Thermal shutdown and current limit protection

Applications

- Cellular phones and pagers
- Cellular accessories
- Battery-powered equipment
- Laptop, notebook, and palmtop computers
- Consumer/personal electronics

Typical Application

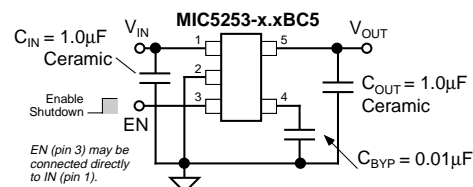

Ultra-Low-Noise Regulator Application

Ordering Information

Part Number				Voltage*	Junction Temp. Range	Package
Standard	Marking	Pb-Free	Marking**			
MIC5253-1.5BC5	715	MIC5253-1.5YC5	<u>715</u>	1.5V	-40°C to +125°C	SC-70-5
MIC5253-1.8BC5	718	MIC5253-1.8YC5	<u>718</u>	1.8V	-40°C to +125°C	SC-70-5
MIC5253-1.85BC5	71J	MIC5253-1.85YC5	<u>71J</u>	1.85V	-40°C to +125°C	SC-70-5
MIC5253-2.5BC5	725	MIC5253-2.5YC5	<u>725</u>	2.5V	-40°C to +125°C	SC-70-5
MIC5253-2.6BC5	726	MIC5253-2.6YC5	<u>726</u>	2.6V	-40°C to +125°C	SC-70-5
MIC5253-2.7BC5	727	MIC5253-2.7YC5	<u>727</u>	2.7V	-40°C to +125°C	SC-70-5
MIC5253-2.8BC5	728	MIC5253-2.8YC5	<u>728</u>	2.8V	-40°C to +125°C	SC-70-5
MIC5253-2.9BC5	729	MIC5253-2.9YC5	<u>729</u>	2.9V	-40°C to +125°C	SC-70-5
MIC5253-3.0BC5	730	MIC5253-3.0YC5	<u>730</u>	3.0V	-40°C to +125°C	SC-70-5
MIC5253-3.1BC5	731	MIC5253-3.1YC5	<u>731</u>	3.1V	-40°C to +125°C	SC-70-5
MIC5253-3.2BC5	732	MIC5253-3.2YC5	<u>732</u>	3.2V	-40°C to +125°C	SC-70-5
MIC5253-3.3BC5	733	MIC5253-3.3YC5	<u>733</u>	3.3V	-40°C to +125°C	SC-70-5

* Other voltage options available. Contact Micrel Marketing for details.

** Under bar symbol () may not be to scale.

Pin Configuration

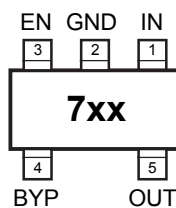

SC-70-5 (C5)

Pin Description

Pin Number	Pin Name	Pin Function
1	IN	Supply Input.
2	GND	Ground.
3	EN	Enable/Shutdown (Input): CMOS compatible input. Logic high = enable; logic low = shutdown. Do not leave open.
4	BYP	Reference Bypass: Connect external $0.01\mu\text{F} \leq C_{\text{BYP}} \leq 1.0\mu\text{F}$ capacitor to GND to reduce output noise. May be left open.
5	OUT	Regulator Output.

Absolute Maximum Ratings⁽¹⁾

Supply Input Voltage (V_{IN})	0V to +7V
Enable Input Voltage (V_{EN})	0V to +7V
Power Dissipation (P_D)	Internally Limited ⁽³⁾
Junction Temperature (T_J)	-40°C to +125°C
Storage Temperature	-65°C to +150°C
Lead Temperature (soldering, 5 sec.)	260°C
ESD Rating ⁽⁴⁾	2kV

Operating Ratings⁽²⁾

Input Voltage (V_{IN})	+2.7V to +5.5V
Enable Input Voltage (V_{EN})	0V to V_{IN}
Junction Temperature (T_J)	-40°C to +125°C
Thermal Resistance SC-70-5 (θ_{JA})	400°C/W

Electrical Characteristics⁽⁵⁾

$V_{IN} = V_{OUT} + 1V$, $V_{EN} = V_{IN}$; $I_{OUT} = 100\mu A$; $T_J = 25^\circ C$, **bold** values indicate $-40^\circ C \leq T_J \leq +125^\circ C$; unless otherwise noted.

Symbol	Parameter	Conditions	Min	Typical	Max	Units
V_O	Output Voltage Accuracy	$I_{OUT} = 100\mu A$	-1.5 -3		1.5 3	% %
ΔV_{LNR}	Line Regulation	$V_{IN} = V_{OUT} + 1V$ to 6V		0.035	0.05	%/V
ΔV_{LDR}	Load Regulation	$I_{OUT} = 0.1mA$ to 100mA, Note 6		1.5	2.5	%
$V_{IN} - V_{OUT}$	Dropout Voltage ⁽⁷⁾	$I_{OUT} = 50mA$		80	150	mV
		$I_{OUT} = 100mA$		165	300	mV
I_Q	Quiescent Current	$V_{EN} \leq 0.4V$ (shutdown)		0.2	1	μA
I_{GND}	Ground Pin Current ⁽⁸⁾	$I_{OUT} = 0mA$		75	100	μA
		$I_{OUT} = 100mA$		90	150	μA
PSRR	Ripple Rejection	$f = 100Hz$, $C_{OUT} = 1.0\mu F$, $C_{BYP} = 0.1\mu F$		66		dB
		$f = 1kHz$, $V_{IN} = V_{OUT} + 1$, $C_{BYP} = 0.1\mu F$		70		dB
		$f = 10kHz$, $V_{IN} = V_{OUT} + 1$, $C_{BYP} = 0.1\mu F$		65		dB
t_{ON}	Turn-On Time			30	150	μs
I_{LIM}	Current Limit	$V_{OUT} = 0V$	150	250	450	mA
e_n	Output Voltage Noise	$C_{OUT} = 1.0\mu F$, $C_{BYP} = 0.01\mu F$, $f = 10Hz$ to 100kHz		30		μV (rms)

Enable Input

V_{IL}	Enable Input Logic-Low Voltage	$V_{IN} = 2.7V$ to 5.5V, regulator shutdown			0.4	V
V_{IH}	Enable Input Logic-High Voltage	$V_{IN} = 2.7V$ to 5.5V, regulator enabled	1.6			V
I_{EN}	Enable Input Current	$V_{IL} \leq 0.4V$, regulator shutdown		0.01		μA
		$V_{IH} \geq 1.6V$, regulator enabled		0.01		μA

Thermal Protection

	Thermal Shutdown Temperature			150		°C
	Thermal Shutdown Hysteresis			10		°C

Notes:

- Exceeding the absolute maximum ratings may damage the device.
- The device is not guaranteed to function outside its operating ratings.
- The maximum allowable power dissipation of any T_A (ambient temperature) is $P_{D(max)} = (T_{J(max)} - T_A) / \theta_{JA}$. Exceeding the maximum allowable power dissipation will result in excessive die temperature, and the regulator will go into thermal shutdown. The θ_{JA} of the MIC5253-x.xBC5 (all versions) is 400°C/W on a PC board (see "Thermal Considerations" section for further details).
- Devices are ESD sensitive. Handling precautions recommended.
- Specification for packaged product only.
- Regulation is measured at constant junction temperature using low duty cycle pulse testing. Parts are tested for load regulation in the load range from 0.1mA to 100mA. Changes in output voltage due to heating effects are covered by the thermal regulation specification.
- Dropout Voltage is defined as the input to output differential at which the output voltage drops 2% below its nominal value measured at 1V differential. For outputs below 2.7V, dropout voltage is the input-to-output voltage differential with the minimum input voltage 2.7V. Minimum input operating voltage is 2.7V.
- Ground pin current is the regulator quiescent current. The total current drawn from the supply is the sum of the load current plus the ground pin current.

Typical Characteristics

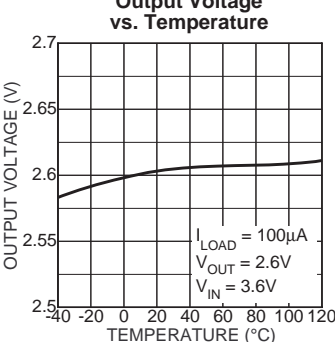
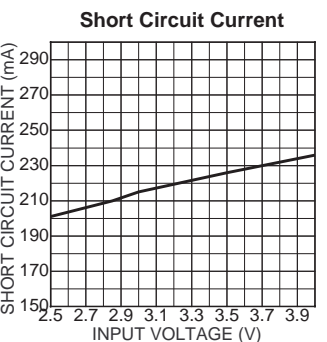
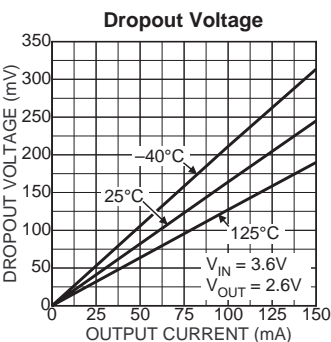
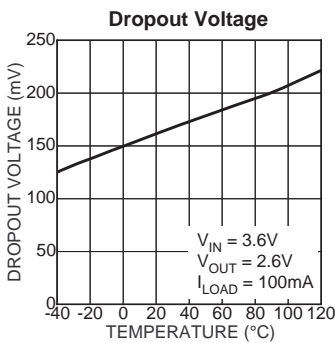
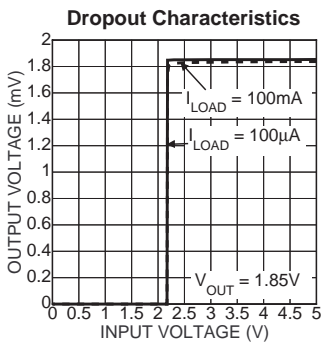
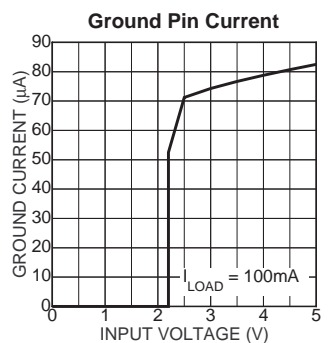
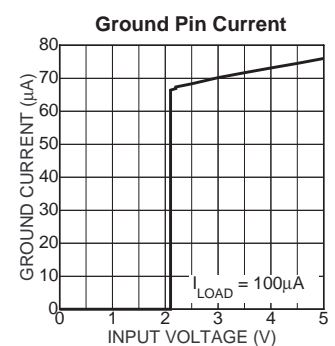
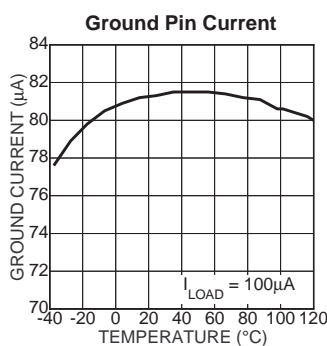
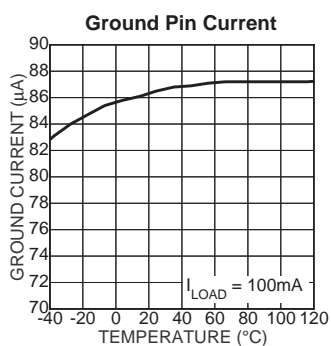
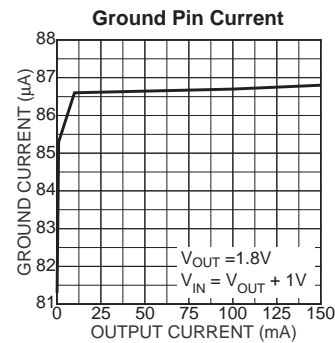
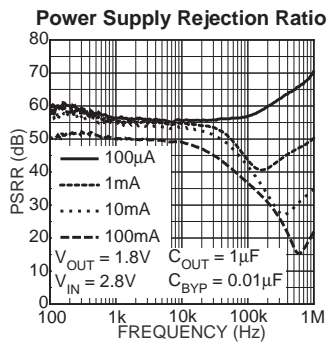
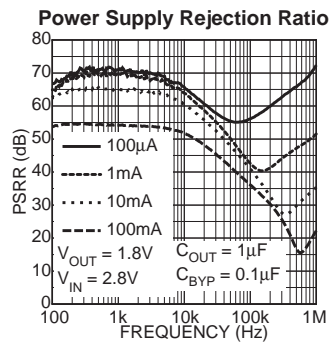

Functional Characteristics

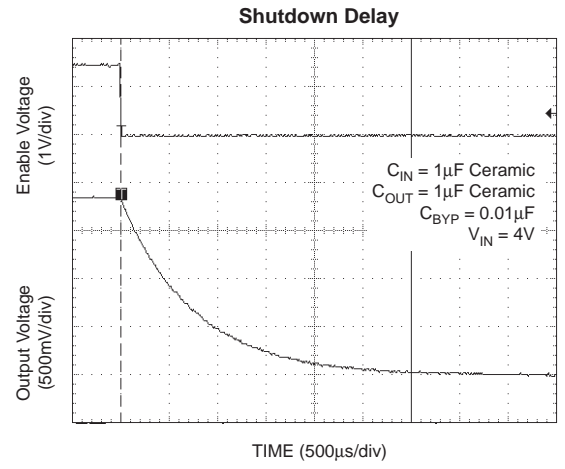
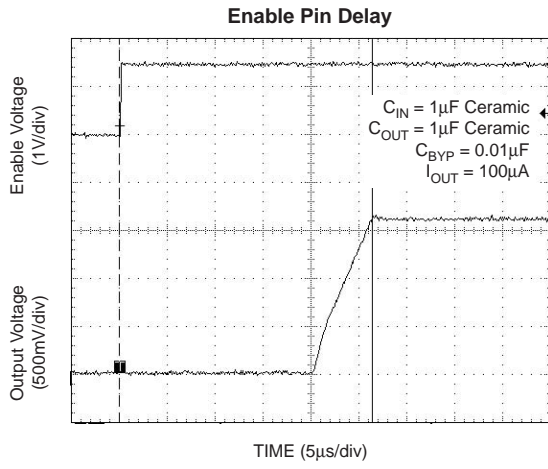
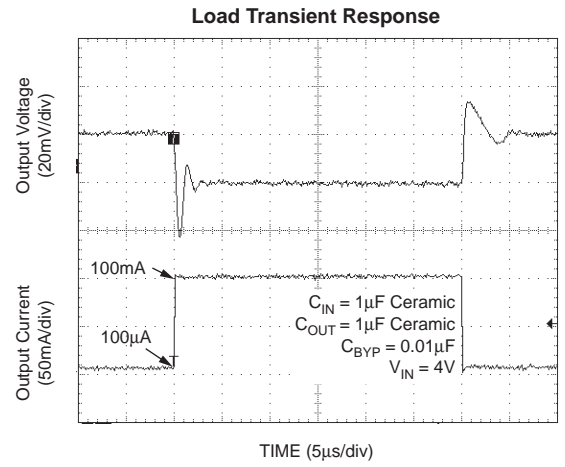
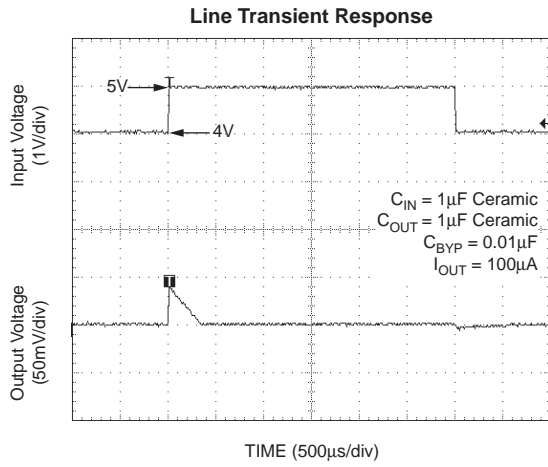

Block Diagram

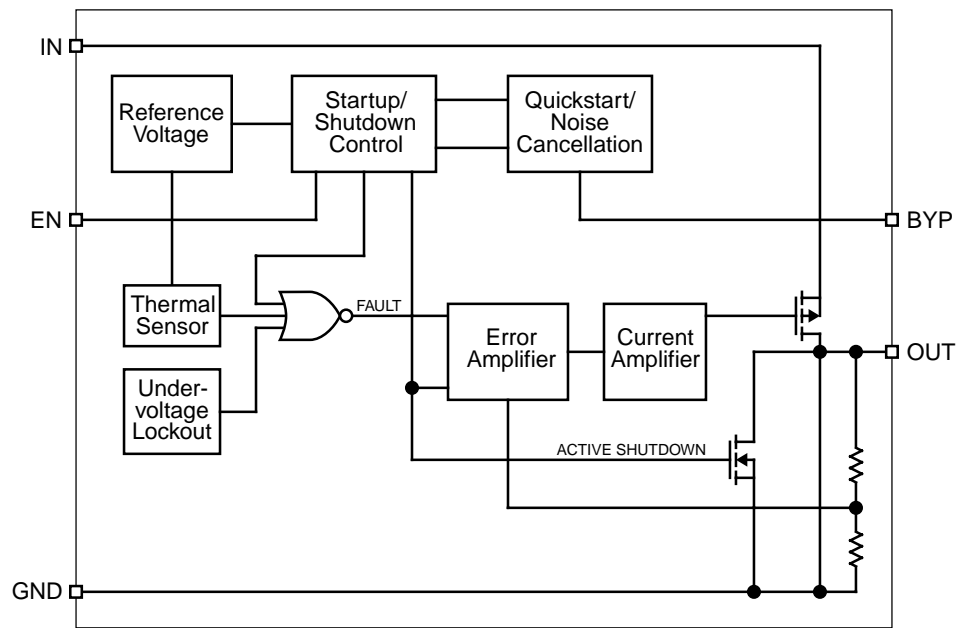

Applications Information

Enable/Shutdown

The MIC5253 comes with an active-high enable pin that allows the regulator to be disabled. Forcing the enable pin low disables the regulator and sends it into a “zero” off-mode-current state. In this state, current consumed by the regulator goes nearly to zero. Forcing the enable pin high enables the output voltage. This part is CMOS and the enable pin cannot be left floating; a floating enable pin may cause an indeterminate state on the output.

Input Capacitor

The MIC5253 is a high performance, high bandwidth device. Therefore, it requires a well-bypassed input supply for optimal performance. A 1 μ F capacitor is required from the input to ground to provide stability. Low-ESR ceramic capacitors provide optimal performance at a minimum of space. Additional high-frequency capacitors, such as small valued NPO dielectric type capacitors, help filter out high frequency noise and are good practice in any RF based circuit.

Output Capacitor

The MIC5253 requires an output capacitor for stability. The design requires 1 μ F or greater on the output to maintain stability. The design is optimized for use with low-ESR ceramic chip capacitors. High ESR capacitors may cause high frequency oscillation. The maximum recommended ESR is 300m Ω . The output capacitor can be increased, but performance has been optimized for a 1 μ F ceramic output capacitor and does not improve significantly with larger capacitance.

X7R/X5R dielectric-type ceramic capacitors are recommended because of their temperature performance. X7R-type capacitors change capacitance by 15% over their operating temperature range and are the most stable type of ceramic capacitors. Z5U and Y5V dielectric capacitors change value by as much as 50% and 60%, respectively, over their operating temperature ranges. To use a ceramic chip capacitor with Y5V dielectric, the value must be much higher than an X7R ceramic capacitor to ensure the same minimum capacitance over the equivalent operating temperature range.

Bypass Capacitor

A capacitor can be placed from the noise bypass pin to ground to reduce output voltage noise. The capacitor bypasses the internal reference. A 0.01 μ F capacitor is recommended for applications that require low-noise outputs. The bypass capacitor can be increased, further reducing noise and improving PSRR. Turn-on time increases slightly with respect to bypass capacitance. A unique quick-start circuit allows the MIC5253 to drive a large capacitor on the bypass pin without significantly slowing turn-on time. Refer to the “Typical Characteristics” section for performance with different bypass capacitors.

Active Shutdown

The MIC5253 also features an active shutdown clamp, which is an N-channel MOSFET that turns on when the device is disabled. This allows the output capacitor and load to discharge, de-energizing the load.

No-Load Stability

The MIC5253 will remain stable and in regulation with no load unlike many other voltage regulators. This is especially important in CMOS RAM keep-alive applications.

Thermal Considerations

The MIC5253 is designed to provide 100mA of continuous current in a very small package. Maximum ambient operating temperature can be calculated based on the output current and the voltage drop across the part. Given that the input voltage is 5.0V, the output voltage is 2.9V, and the output current = 100mA.

The actual power dissipation of the regulator circuit can be determined using the equation:

$$P_D = (V_{IN} - V_{OUT}) I_{OUT} + V_{IN} I_{GND}$$

Because this device is CMOS and the ground current is typically <100 μ A over the load range, the power dissipation contributed by the ground current is < 1% and can be ignored for this calculation.

$$P_D = (5.0V - 2.9V) \times 100mA$$

$$P_D = 0.21W$$

To determine the maximum ambient operating temperature of the package, use the junction-to-ambient thermal resistance of the device and the following basic equation:

$$P_D(\max) = \left(\frac{T_J(\max) - T_A}{\theta_{JA}} \right)$$

$$T_J(\max) = 125^\circ\text{C}, \text{ the max. junction temperature of the die}$$

$$\theta_{JA} \text{ thermal resistance} = 400^\circ\text{C/W}$$

Table 1 shows junction-to-ambient thermal resistance for the MIC5253 in the SC-70 package.

Package	θ_{JA} Recommended Minimum Footprint	θ_{JA} 1" Sq. Copper Clad	θ_{JC}
SC-70-5 (C5)	400 $^\circ\text{C/W}$	325 $^\circ\text{C}$	250 $^\circ\text{C/W}$

Table 1. Thermal Resistance

Substituting P_D for $P_D(\max)$ and solving for the ambient operating temperature will give the maximum operating conditions for the regulator circuit. The junction-to-ambient thermal resistance for the minimum footprint is 400 $^\circ\text{C/W}$, from Table 1. The maximum power dissipation must not be exceeded for proper operation.

For example, when operating the MIC5253-2.9BC5 at an input voltage of 5.0V and 100mA load with a minimum footprint layout, the maximum ambient operating temperature T_A can be determined as follows:

$$0.21W = \frac{125^\circ\text{C} - T_A}{400^\circ\text{C/W}}$$

$$T_A = 41^\circ\text{C}$$

Therefore, a 2.9V application at 100mA of output current can accept an ambient operating temperature of 41°C in a SC-70 package. For a full discussion of heat sinking and thermal effects on voltage regulators, refer to the “Regulator Thermals” section of *Micrel's Designing with Low-Dropout Voltage Regulators* handbook. This information can be found on Micrel's website at:

http://www.micrel.com/_PDF/other/LDOBk_ds.pdf

Package Information

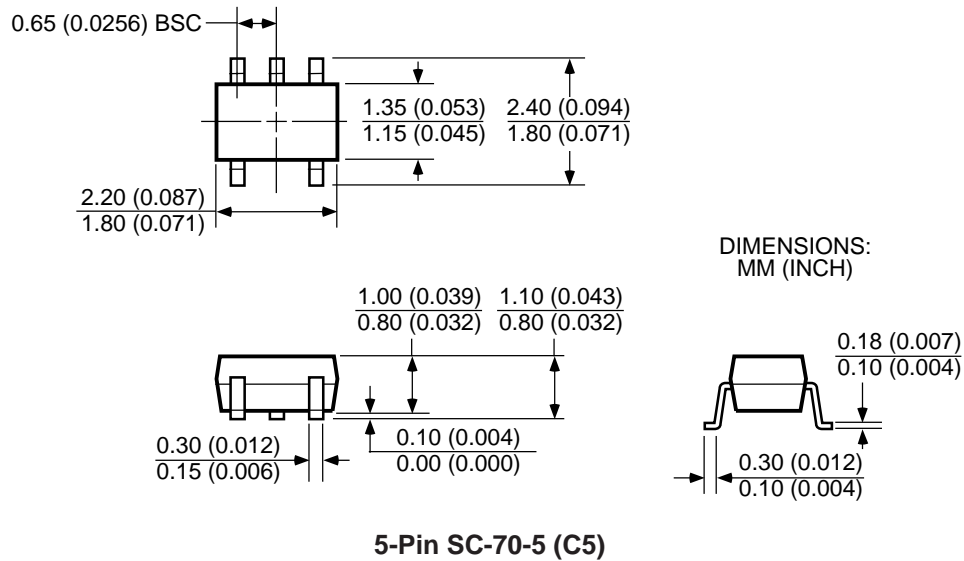

MICREL, INC. 1849 FORTUNE DRIVE SAN JOSE, CA 95131 USA

TEL + 1 (408) 944-0800 FAX + 1 (408) 474-1000 WEB <http://www.micrel.com>

The information furnished by Micrel in this data sheet is believed to be accurate and reliable. However, no responsibility is assumed by Micrel for its use. Micrel reserves the right to change circuitry and specifications at any time without notification to the customer.

Micrel Products are not designed or authorized for use as components in life support appliances, devices or systems where malfunction of a product can reasonably be expected to result in personal injury. Life support devices or systems are devices or systems that (a) are intended for surgical implant into the body or (b) support or sustain life, and whose failure to perform can be reasonably expected to result in a significant injury to the user. A Purchaser's use or sale of Micrel Products for use in life support appliances, devices or systems is at Purchaser's own risk and Purchaser agrees to fully indemnify Micrel for any damages resulting from such use or sale.

© 2004 Micrel, Incorporated.

Mouser Electronics

Authorized Distributor

Click to View Pricing, Inventory, Delivery & Lifecycle Information:

Micrel:

[MIC5253-3.3YC5 TR](#) [MIC5253-1.5YC5 TR](#) [MIC5253-3.1YC5 TR](#) [MIC5253-2.5YC5 TR](#) [MIC5253-2.6YC5 TR](#)
[MIC5253-2.7YC5 TR](#) [MIC5253-1.85YC5 TR](#) [MIC5253-2.9YC5 TR](#) [MIC5253-1.8YC5 TR](#) [MIC5253-2.85YC5 TR](#)
[MIC5253-3.2YC5 TR](#) [MIC5253-3.0YC5 TR](#) [MIC5253-2.8YC5 TR](#)