



MIC860

Teeny™ Ultra-Low Power Op Amp

General Description

The MIC860 is a rail-to-rail output, operational amplifier in Teeny™ SC70 packaging. The MIC860 provides 4MHz gain-bandwidth product while consuming an incredibly low 30µA supply current.

The SC70 packaging achieves significant board space savings over devices packaged in SOT-23 or MSOP-8 packaging.

The SC70 occupies approximately half the board area of an SOT-23 package.

Datasheets and support documentation are available on Micrel's web site at: www.micrel.com.

Features

- Teeny™ SC70 packaging
- 4MHz gain-bandwidth product
- 30µA supply current
- Rail-to-rail output
- Ground sensing at input common mode to GND
- Common mode to GND
- Drives large capacitive loads

Applications

- Portable equipment
- PDAs
- Pagers
- Cordless phones
- Consumer electronics

Functional Pinout

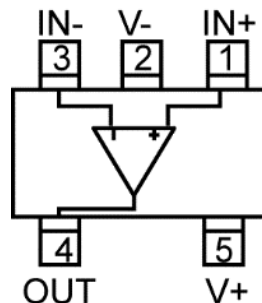

Teeny is a trademark of Micrel, Inc.

Micrel Inc. • 2180 Fortune Drive • San Jose, CA 95131 • USA • tel +1 (408) 944-0800 • fax + 1 (408) 474-1000 • <http://www.micrel.com>

September 9, 2014

Revision 2.0

Ordering Information

Part Number	Marking ⁽¹⁾	Junction Temp. Range	Package
MIC860YC5	<u>A32</u>	-40°C to +85°C	5-Pin SC-70

Note:

- Underbar marking may not be to scale.

Pin Configuration

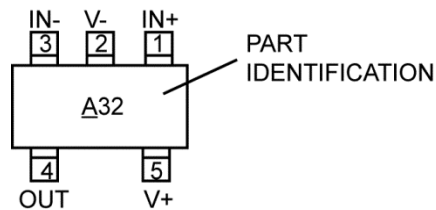

5-pin SC-70 (C5)
(Top View)

Pin Description

Pin Number	Pin Name	Pin Function
1	IN+	Non-inverting input.
2	V-	Negative power supply connection. Connect a 10 μ F and 0.1 μ F capacitor in parallel to this pin for power supply bypassing.
3	IN-	Inverting input.
4	OUT	Output of operational amplifier.
5	V+	Positive power supply input. Connect a 10 μ F and 0.1 μ F capacitor in parallel to this pin for power supply bypassing.

Absolute Maximum Ratings⁽²⁾

Supply Voltage ($V_{V+} - V_{V-}$)	+6.0V
Differential Input Voltage ($ V_{IN+} - V_{IN-} $) ⁽⁵⁾	+6.0V
Input Voltage ($V_{IN+} - V_{IN-}$)	$V_+ + 0.3V, V_- - 0.3V$
Lead Temperature (soldering, 5 sec.)	260°C
Output Short-Circuit Current Duration	Indefinite
Storage Temperature (T_S)	150°C
ESD Rating ⁽⁴⁾	ESD Sensitive

Operating Ratings⁽³⁾

Supply Voltage ($V_{V+} - V_{V-}$)	+2.43V to +5.25V
Ambient Temperature (T_A)	-40°C to +85°C
Packaging Thermal Resistance	
5-pin SC-70 (θ_{JA})	450°C/W

Electrical Characteristics

$V_+ = +2.7V, V_- = 0V, V_{CM} = V_+/2; R_L = 500k\Omega$ to $V_+/2; T_A = 25^\circ C$, unless otherwise noted. **Bold** values indicate $-40^\circ C \leq T_A \leq +85^\circ C$.

Symbol	Parameter	Condition	Min.	Typ.	Max.	Units
V_{OS}	Input Offset Voltage		-20	-5	15	mV
			-25		20	mV
	Input Offset Voltage Temp Coefficient			20		$\mu V/^\circ C$
I_B	Input Bias Current			20		pA
I_{OS}	Input Offset Current			10		pA
V_{CM}	Input Voltage Range	CMRR > 60dB	1	1.8		V
CMRR	Common-Mode Rejection Ratio	$0 < V_{CM} < 1.35V$	38	76		dB
PSRR	Power Supply Rejection Ratio	Supply voltage change of 3V	40	78		dB
A_{VOL}	Large-Signal Voltage Gain	$R_L = 5k\Omega, V_{OUT} = 2V_{PP}$	50	66		dB
		$R_L = 100k\Omega, V_{OUT} = 2V_{PP}$	66	81		dB
		$R_L = 500k\Omega, V_{OUT} = 2V_{PP}$	76	91		dB
V_{OUT}	Maximum Output Voltage Swing	$R_L = 5k\Omega$	$V \pm 70mV$	$V \pm 34mV$		V
		$R_L = 500k\Omega$	$V \pm 2mV$	$V \pm 0.7mV$		V
V_{OUT}	Minimum Output Voltage Swing	$R_L = 5k\Omega$		$V \pm 11mV$	$V \pm 50mV$	mV
		$R_L = 500k\Omega$		$V \pm 0.2mV$	$V \pm 2mV$	mV
GBW	Gain-Bandwidth Product			4		MHz
SR	Slew Rate			3		V/ μs
I_{SC}	Short-Circuit Output Current	Source	4.5	6		mA
		Sink	10	16		mA
I_S	Supply Current	No Load		30	50	μA

Notes:

- Exceeding the absolute maximum ratings may damage the device.
- The device is not guaranteed to function outside its operating ratings.
- Devices are ESD sensitive. Handling precautions are recommended. Human body model, 1.5k Ω in series with 100pF. Pin 4 is ESD sensitive.
- Exceeding the maximum differential input voltage will damage the input stage and degrade performance (in particular, input bias current is likely to increase).

Electrical Characteristics⁽⁵⁾ (Continued)

$V_{+} = +5V$, $V_{-} = 0V$, $V_{CM} = V_{+}/2$; $R_L = 500k\Omega$ to $V_{+}/2$; $T_A = 25^{\circ}C$, unless otherwise noted. **Bold** values indicate $-40^{\circ}C \leq T_A \leq +85^{\circ}C$.

Symbol	Parameter	Condition	Min.	Typ.	Max.	Units
V_{OS}	Input Offset Voltage		-20	-5	20	mV
	Input Offset Voltage Temp Coefficient			20		$\mu V/^{\circ}C$
I_B	Input Bias Current			20		pA
I_{OS}	Input Offset Current			10		pA
V_{CM}	Input Voltage Range	CMRR > 60dB	3.5	4.2		V
CMRR	Common-Mode Rejection Ratio	$0 < V_{CM} < 3.5V$	44	77		dB
PSRR	Power Supply Rejection Ratio	Supply voltage change of 1V	40	79		dB
A_{VOL}	Large-Signal Voltage Gain	$R_L = 5k\Omega$, $V_{OUT} 4.8V_{PP}$	52	66		dB
		$R_L = 100k\Omega$, $V_{OUT} 4.8V_{PP}$	67	80		dB
		$R_L = 500k\Omega$, $V_{OUT} 4.8V_{PP}$	75	90		dB
V_{OUT}	Maximum Output Voltage Swing	$R_L = 5k\Omega$	$V_{\pm 75mV}$	$V_{\pm 37mV}$		V
		$R_L = 500k\Omega$	$V_{\pm 35mV}$	$V_{\pm 4mV}$		V
V_{OUT}	Minimum Output Voltage Swing	$R_L = 5k\Omega$		$V_{\pm 14mV}$	$V_{\pm 40mV}$	mV
		$R_L = 500k\Omega$		$V_{\pm 0.4mV}$	$V_{\pm 5mV}$	mV
GBW	Gain-Bandwidth Product			4		MHz
SR	Slew Rate			3		$V/\mu s$
I_{SC}	Short-Circuit Output Current	Source	15	23		mA
		Sink	30	47		mA
I_S	Supply Current	No Load		33	55	μA

Test Circuits

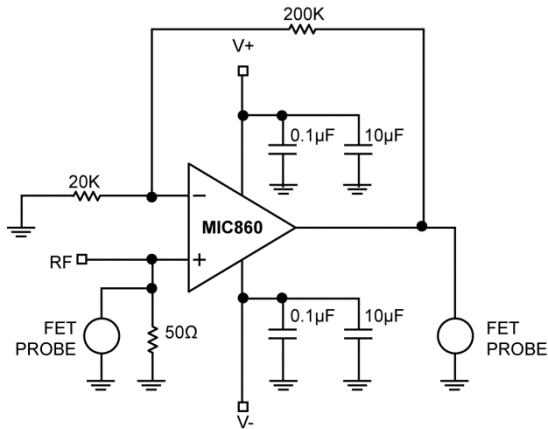

Test Circuit 1. $A_V = 10$

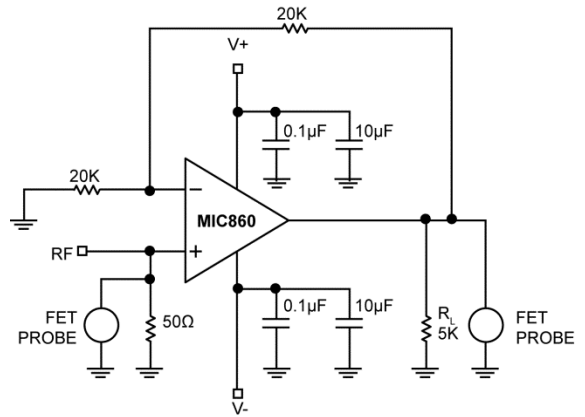

Test Circuit 2. $A_V = 2$

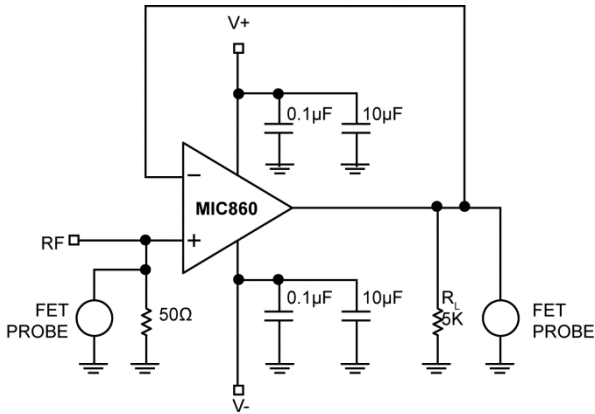

Test Circuit 3. $A_V = 1$

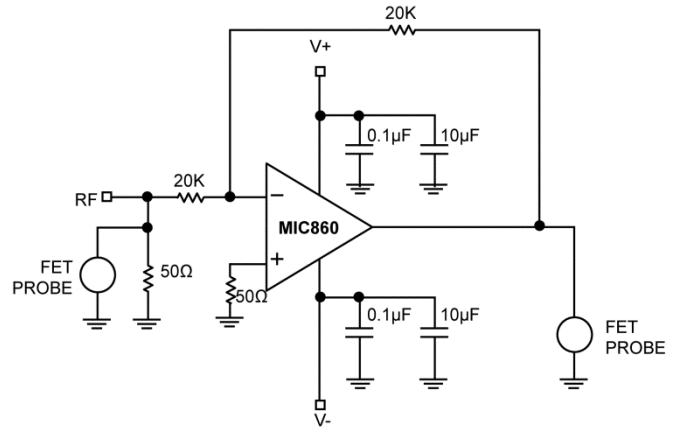

Test Circuit 4. $A_V = -1$

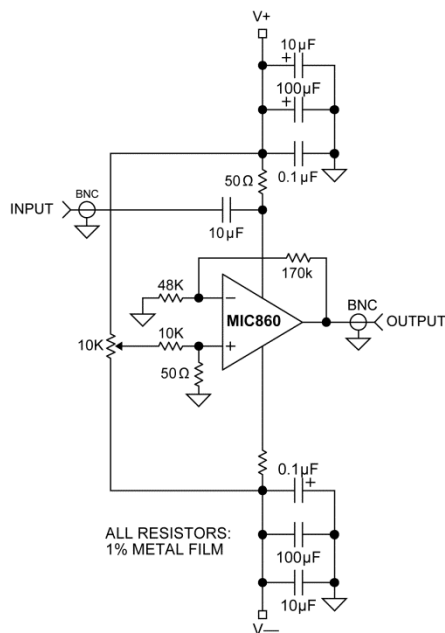

Test Circuit 5. Positive Power Supply Rejection Ratio Measurement

Typical Characteristics

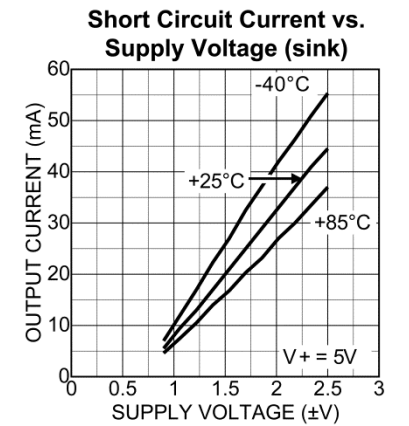
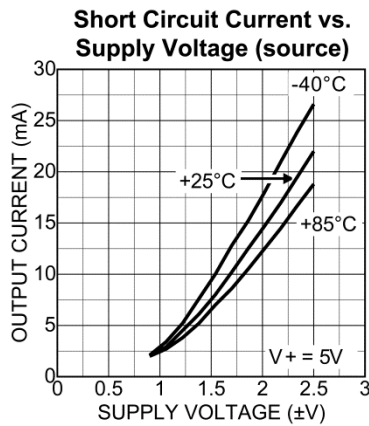
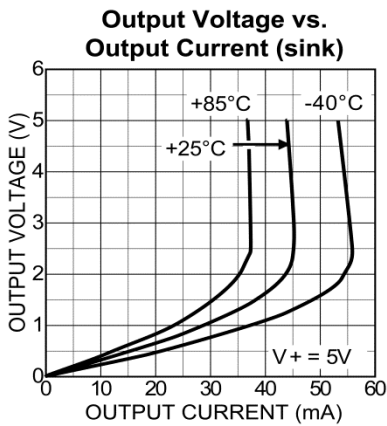
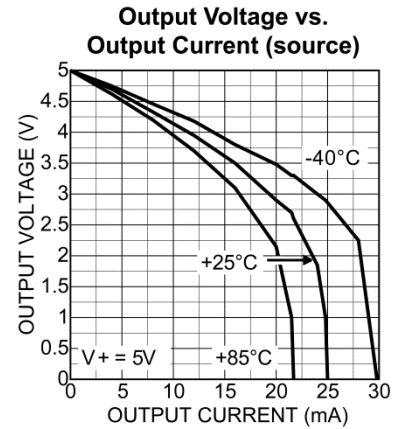
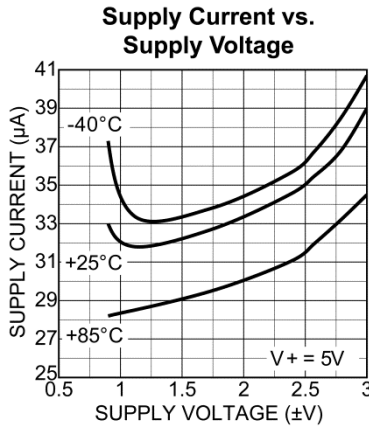
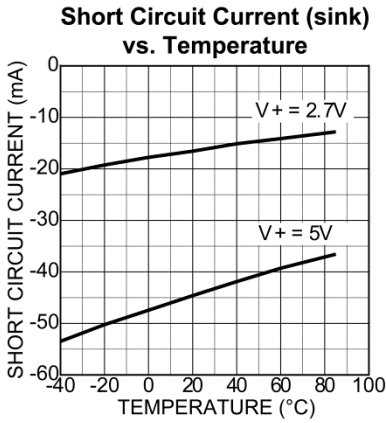
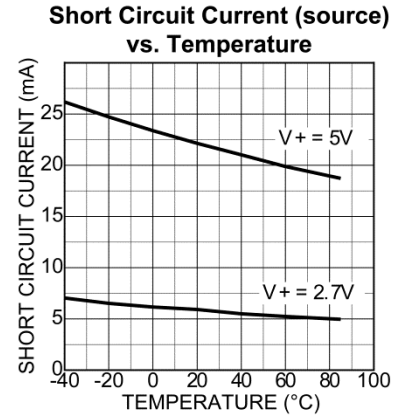
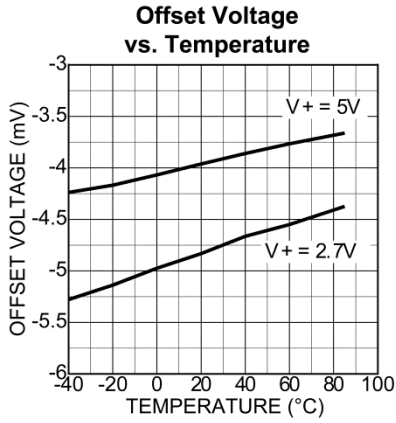
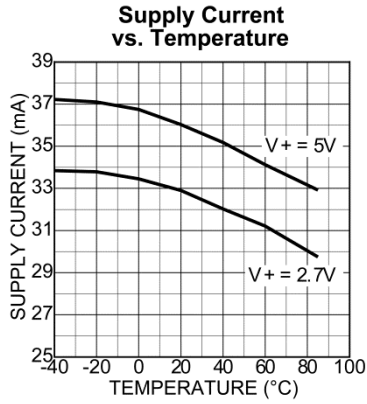

Typical Characteristics (Continued)

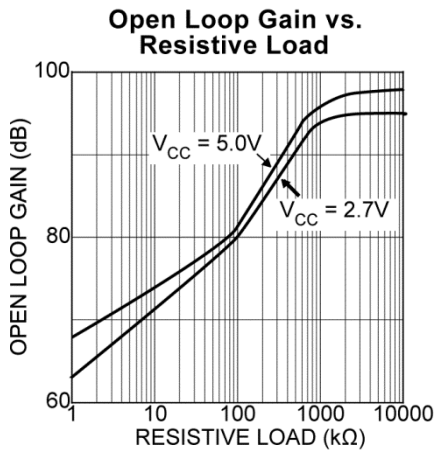
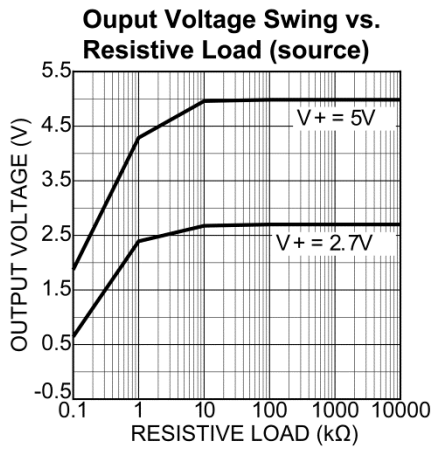
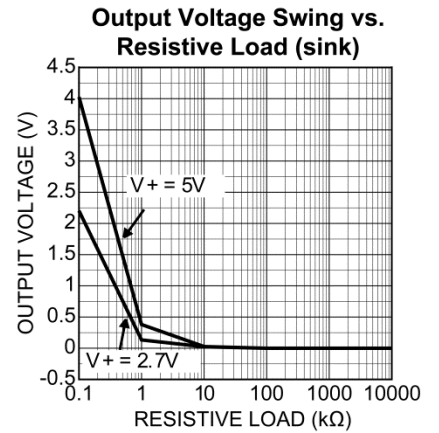
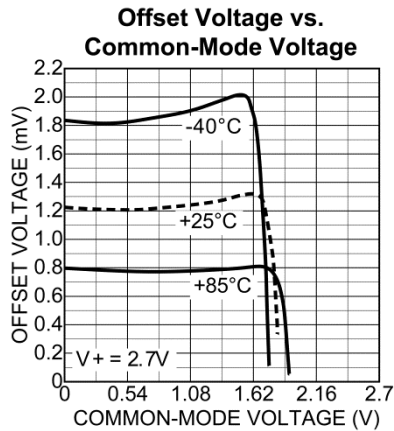
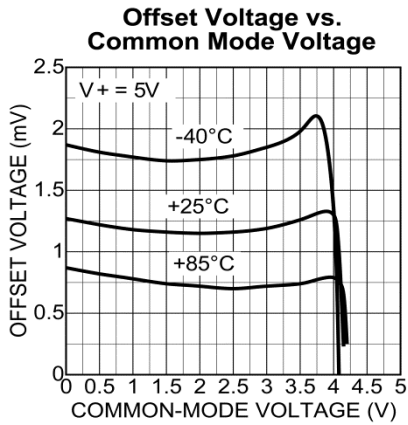

Typical Characteristics (Continued)

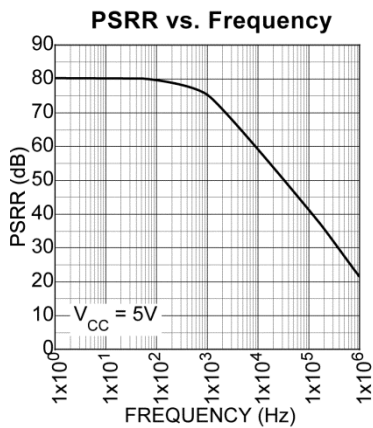
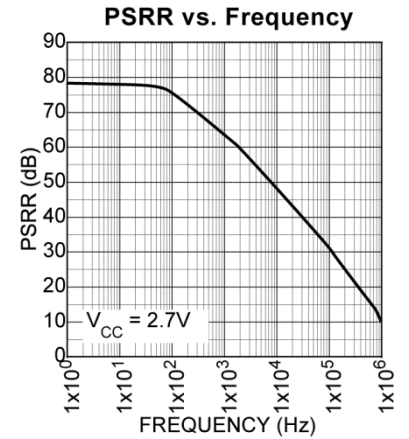
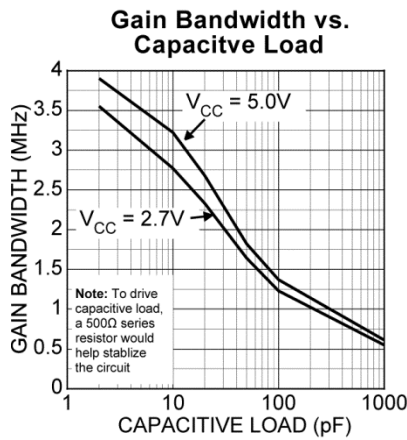
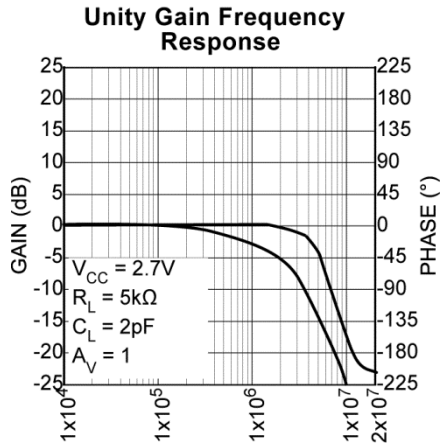
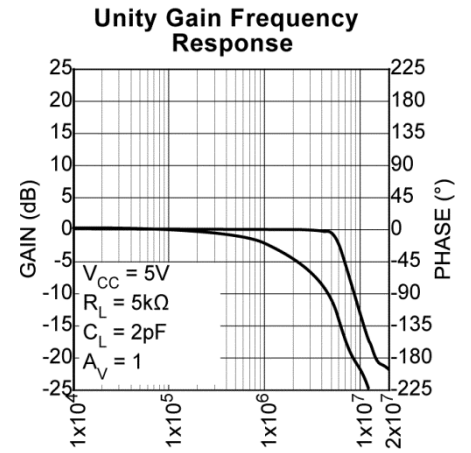
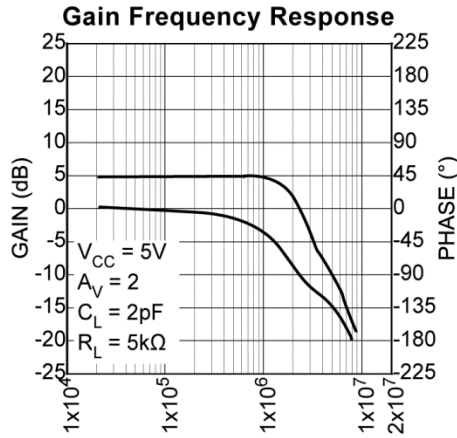
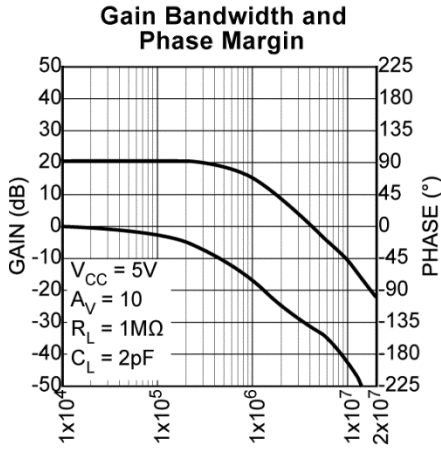

Functional Characteristics (Continued)

Small Signal Response
Test Circuit 3: $A_V = 1$

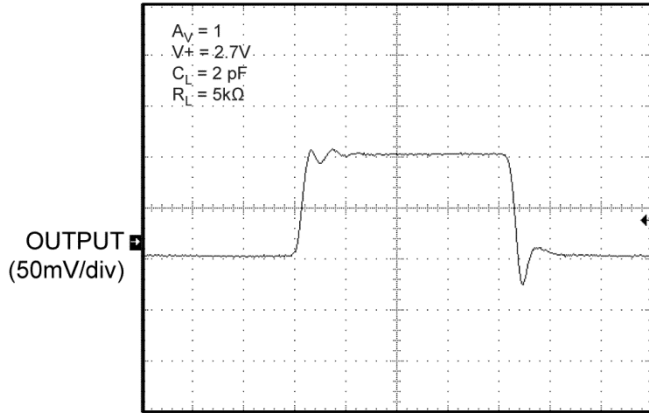

TIME (500ns/div)

Small Signal Response
Test Circuit 3: $A_V = 1$

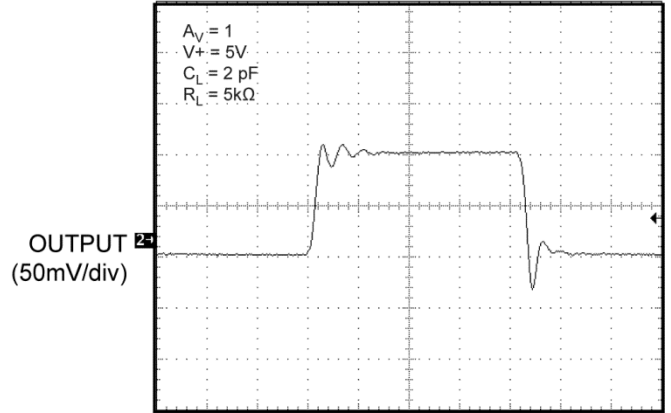

TIME (500ns/div)

Small Signal Response
Test Circuit 3: $A_V = 1$

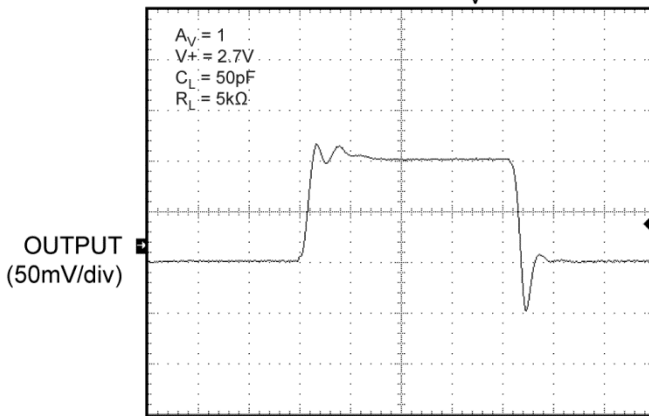

TIME (500ns/div)

Small Signal Response
Test Circuit 3: $A_V = 1$

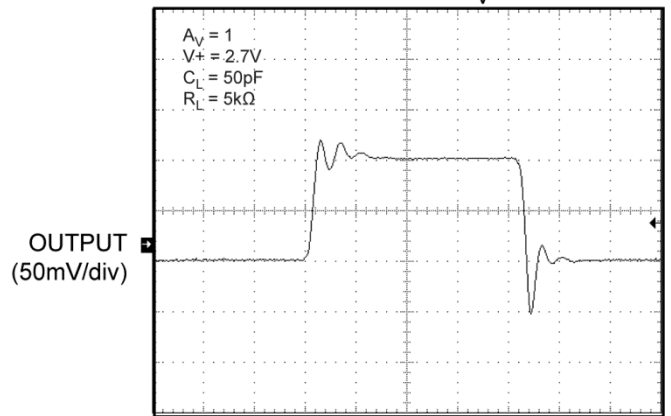

TIME (500ns/div)

Small Signal Response
Test Circuit 3: $A_V = 1$

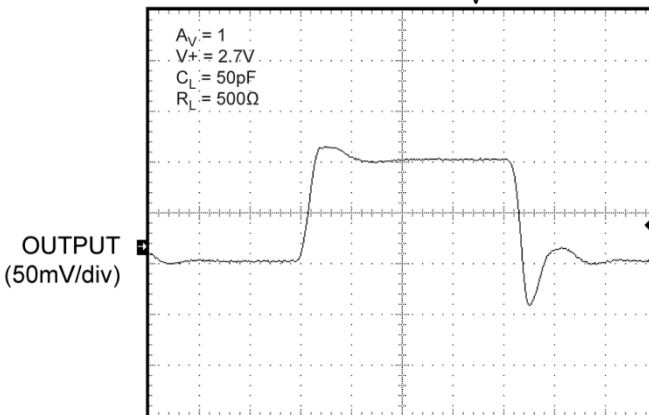

TIME (500ns/div)

Small Signal Response
Test Circuit 3: $A_V = 1$

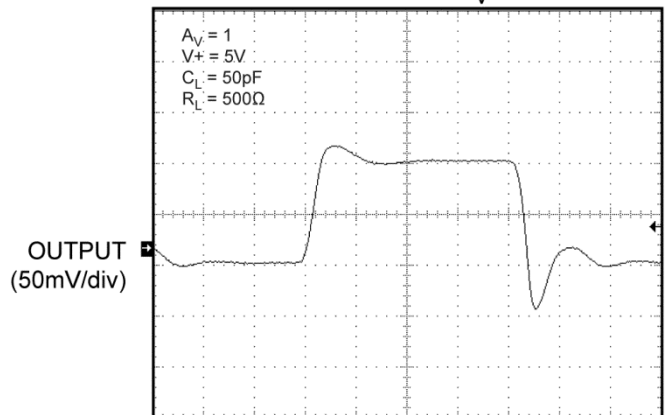

TIME (500ns/div)

Functional Characteristics (Continued)

Small Signal Response
Test Circuit 3: $A_V = 1$

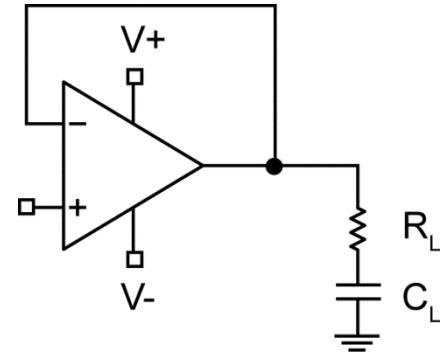
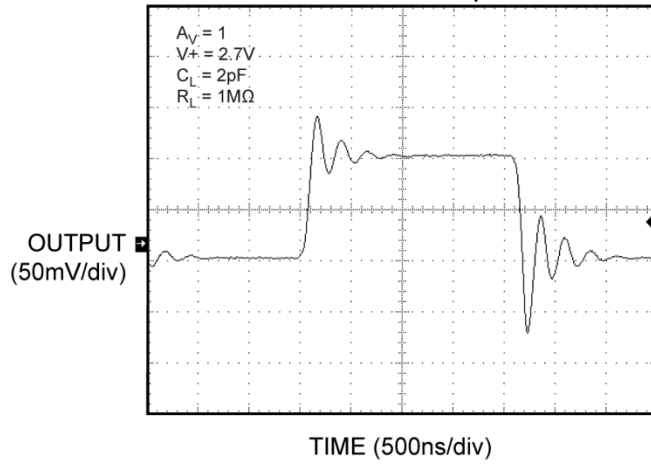

Small Signal Response
Test Circuit 4: $A_V = -1$

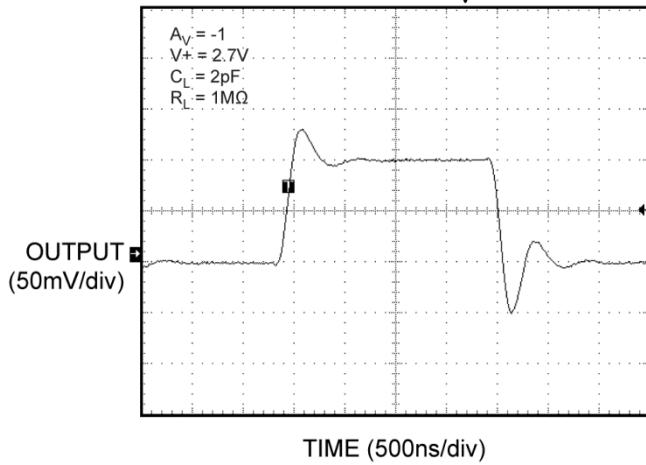

Small Signal Response
Test Circuit 4: $A_V = -1$

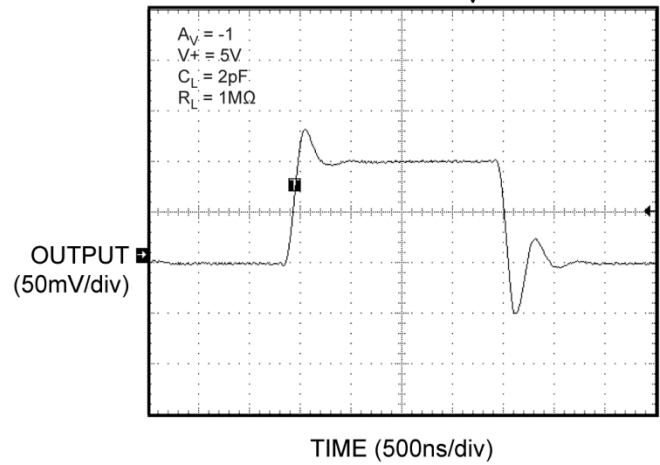

Small Signal Response
Test Circuit 4: $A_V = -1$

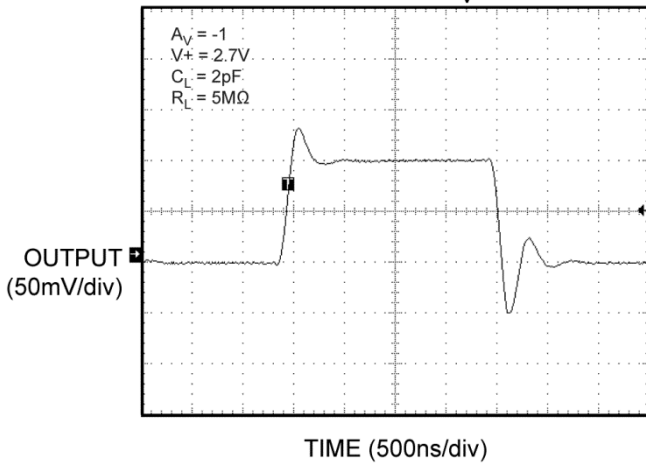

Small Signal Response
Test Circuit 4: $A_V = -1$

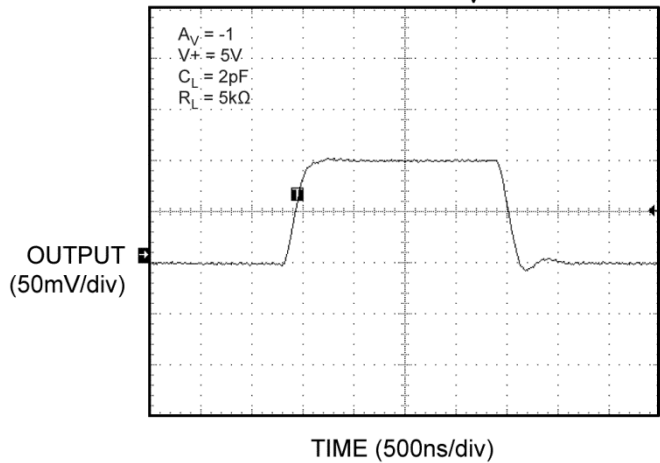

Functional Characteristics (Continued)

Rail to Rail Output Operation
Test Circuit 2: $A_V = 2$

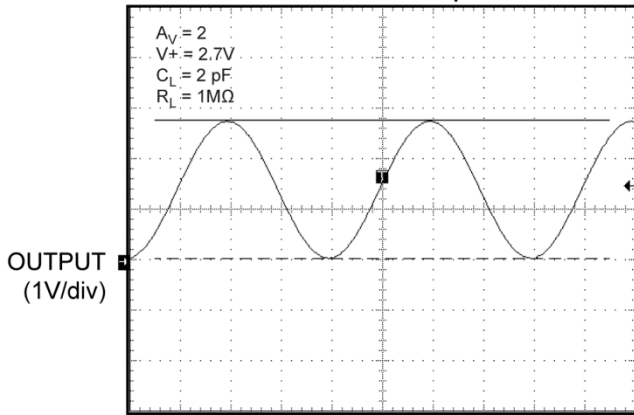

TIME (250μs/div)

Rail to Rail Output Operation
Test Circuit 2: $A_V = 2$

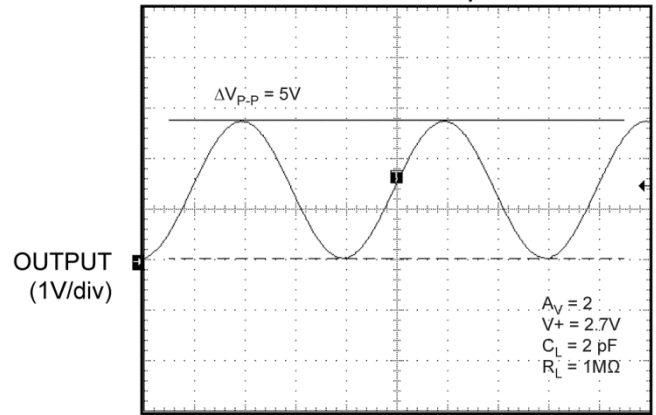

TIME (250μs/div)

Rail to Rail Output Operation
Test Circuit 2: $A_V = 2$

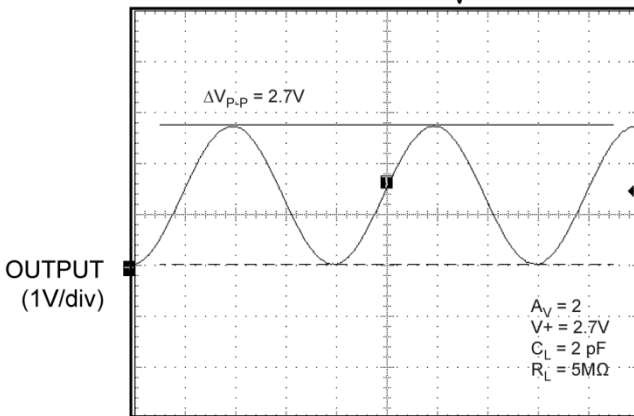

TIME (250μs/div)

Rail to Rail Output Operation
Test Circuit 2: $A_V = 2$

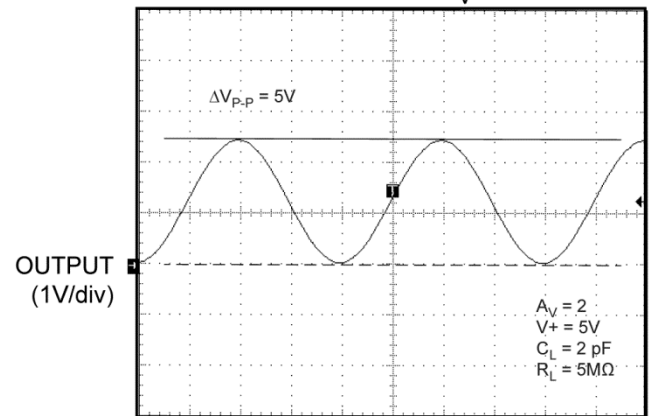

TIME (250μs/div)

Large Signal Pulse Response
Test Circuit 3: $A_V = 1$

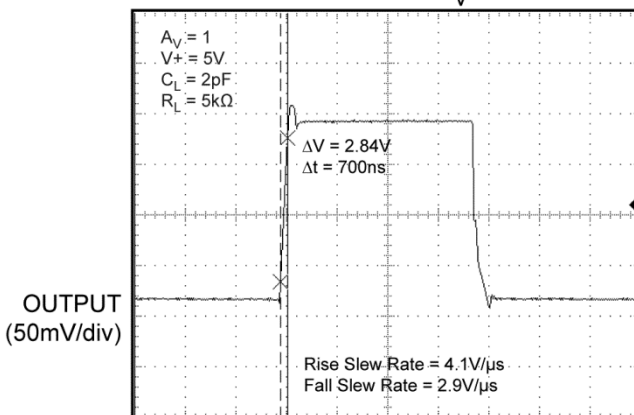

TIME (5μs/div)

Large Signal Pulse Response
Test Circuit 3: $A_V = 1$

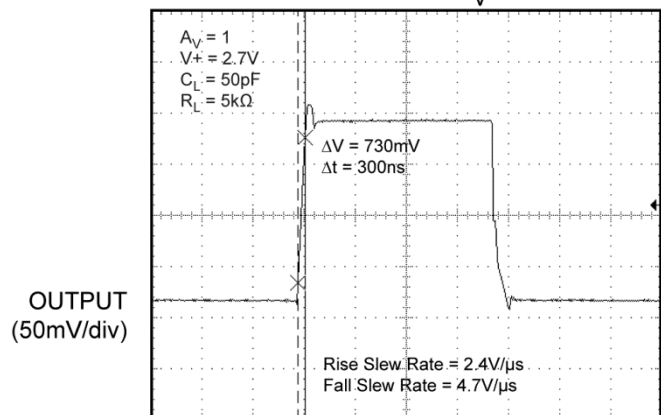

TIME (5μs/div)

Application Information

Power Supply Bypassing

Regular supply bypassing techniques are recommended. A $10\mu\text{F}$ capacitor in parallel with a $0.1\mu\text{F}$ capacitor on both the positive and negative supplies are ideal. For best performance all bypassing capacitors should be located as close to the op amp as possible and all capacitors should be low ESL (equivalent series inductance), ESR (equivalent series resistance). Surface-mount ceramic capacitors are ideal.

Supply and Loading Considerations

The MIC860 is intended for single supply applications configured with a grounded load. It is not advisable to operate the MIC860 with either:

- 1). A grounded load and split supplies ($\pm V$) or
- 2). A single supply where the load is terminated above ground.

Under the above conditions, if the load is less than $20\text{k}\Omega$ and the output swing is greater than $1\text{V}(\text{peak})$, there may be some instability when the output is sinking current.

Package Information and Recommended Land Pattern⁽⁶⁾

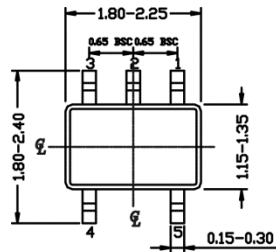

TOP VIEW

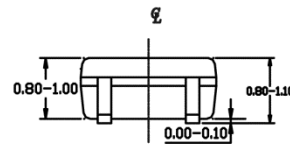

SIDE VIEW

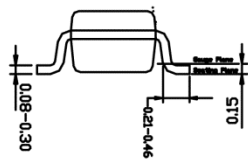

END VIEW

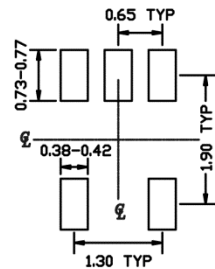

RECOMMENDED LAND PATTERN

NOTE:

1. ALL DIMENSIONS ARE IN MILLIMETERS.
2. DIMENSIONS ARE INCLUSIVE OF PLATING.
3. DIMENSIONS ARE EXCLUSIVE OF MOLD FLASH & METAL BURR.

5-pin SC70 (C5)

Note:

6. Package information is correct as of the publication date. For updates and most current information, go to www.micrel.com.

MICREL, INC. 2180 FORTUNE DRIVE SAN JOSE, CA 95131 USA
 TEL +1 (408) 944-0800 FAX +1 (408) 474-1000 WEB <http://www.micrel.com>

Micrel makes no representations or warranties with respect to the accuracy or completeness of the information furnished in this data sheet. This information is not intended as a warranty and Micrel does not assume responsibility for its use. Micrel reserves the right to change circuitry, specifications and descriptions at any time without notice. No license, whether express, implied, arising by estoppel or otherwise, to any intellectual property rights is granted by this document. Except as provided in Micrel's terms and conditions of sale for such products, Micrel assumes no liability whatsoever, and Micrel disclaims any express or implied warranty relating to the sale and/or use of Micrel products including liability or warranties relating to fitness for a particular purpose, merchantability, or infringement of any patent, copyright or other intellectual property right.

Micrel Products are not designed or authorized for use as components in life support appliances, devices or systems where malfunction of a product can reasonably be expected to result in personal injury. Life support devices or systems are devices or systems that (a) are intended for surgical implant into the body or (b) support or sustain life, and whose failure to perform can be reasonably expected to result in a significant injury to the user. A Purchaser's use or sale of Micrel Products for use in life support appliances, devices or systems is a Purchaser's own risk and Purchaser agrees to fully indemnify Micrel for any damages resulting from such use or sale.

© 2006 Micrel, Incorporated.

Mouser Electronics

Authorized Distributor

Click to View Pricing, Inventory, Delivery & Lifecycle Information:

[Micrel:](#)

[MIC860YC5 TR](#)