

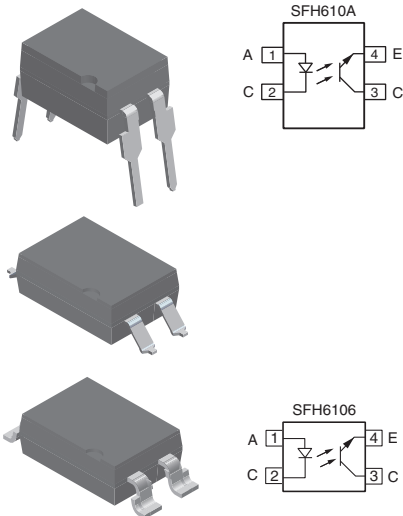

# Optocoupler, Phototransistor Output, High Reliability, 5300 V<sub>RMS</sub>



## FEATURES

- Good CTR linearity depending on forward current
- Isolation test voltage, 5300 V<sub>RMS</sub>
- High collector emitter voltage, V<sub>CEO</sub> = 70 V
- Low saturation voltage
- Fast switching times
- Low CTR degradation
- Temperature stable
- Low coupling capacitance
- End stackable, 0.100" (2.54 mm) spacing
- High common mode interference immunity
- Lead (Pb)-free component
- Material categorization: For definitions of compliance please see [www.vishay.com/doc?99912](http://www.vishay.com/doc?99912)



RoHS COMPLIANT

## DESCRIPTION

The SFH610A (DIP) and SFH6106 (SMD) feature a high current transfer ratio, low coupling capacitance and high isolation voltage. These couplers have a GaAs infrared diode emitter, which is optically coupled to a silicon planar phototransistor detector, and is incorporated in a plastic DIP-4 or SMD package.

The coupling devices are designed for signal transmission between two electrically separated circuits.

The couplers are end-stackable with 2.54 mm spacing.

Creepage and clearance distances of > 8.0 mm are achieved with option 6. This version complies with IEC 60950 (DIN VDE 0805) for reinforced insulation up to an operation voltage of 400 V<sub>RMS</sub> or DC. Specifications subject to change.

## AGENCY APPROVALS

- UL1577, file no. E52744 system code H or J, double protection
- DIN EN 60747-5-5 (VDE 0884) available with option 1
- CSA 93751
- BSI IEC 60950; IEC 60065

## ORDERING INFORMATION

PART	REMARKS
SFH610A-1	CTR 40 % to 80 %, DIP-4
SFH610A-2	CTR 63 % to 125 %, DIP-4
SFH610A-3	CTR 100 % to 200 %, DIP-4
SFH610A-4	CTR 160 % to 320 %, DIP-4
SFH610A-5	CTR 250 % to 500 %, DIP-4
SFH6106-1	CTR 40 % to 80 %, SMD-4
SFH6106-2	CTR 63 % to 125 %, SMD-4
SFH6106-3	CTR 100 % to 200 %, SMD-4
SFH6106-4	CTR 160 % to 320 %, SMD-4
SFH6106-5T	CTR 250 % to 500 %, SMD-4, tape and reel
SFH610A-1X006	CTR 40 % to 80 %, DIP-4 400 mil
SFH610A-1X018T	CTR 40 % to 80 %, SMD-4 400 mil, wide leadspread
SFH610A-2X006	CTR 63 % to 125 %, DIP-4 400 mil
SFH610A-3X006	CTR 100 % to 200 %, DIP-4 400 mil
SFH610A-3X007	CTR 100 % to 200 %, SMD-4
SFH610A-4X006	CTR 160 % to 320 %, DIP-4 400 mil

### Note

- For additional information on the available options refer to option information.



ABSOLUTE MAXIMUM RATINGS (T <sub>amb</sub> = 25 °C, unless otherwise specified)				
PARAMETER	TEST CONDITION	SYMBOL	VALUE	UNIT
<b>INPUT</b>				
Reverse voltage		V <sub>R</sub>	6	V
DC forward current		I <sub>F</sub>	60	mA
Surge forward current	t ≤ 10 μs	I <sub>FSM</sub>	2.5	A
Power dissipation		P <sub>diss</sub>	100	mW
<b>OUTPUT</b>				
Collector emitter voltage		V <sub>CE</sub>	70	V
Emitter collector voltage		V <sub>EC</sub>	7	V
Collector current	t <sub>p</sub> ≤ 1.0 ms	I <sub>C</sub>	50	mA
		I <sub>C</sub>	100	mA
Power dissipation		P <sub>diss</sub>	150	mW
<b>COUPLER</b>				
Isolation test voltage between emitter and detector		V <sub>ISO</sub>	5300	V <sub>RMS</sub>
Creepage distance			≥ 7	mm
Clearance distance			≥ 7	mm
Insulation thickness between emitter and detector			≥ 0.4	mm
Comparative tracking index per DIN IEC112/VDE 0303 part 1			≥ 175	
Isolation resistance	V <sub>IO</sub> = 500 V, T <sub>amb</sub> = 25 °C	R <sub>IO</sub>	≥ 10 <sup>12</sup>	Ω
	V <sub>IO</sub> = 500 V, T <sub>amb</sub> = 100 °C	R <sub>IO</sub>	≥ 10 <sup>11</sup>	Ω
Storage temperature range		T <sub>stg</sub>	- 55 to + 150	°C
Ambient temperature range		T <sub>amb</sub>	- 55 to + 100	°C
Soldering temperature <sup>(1)</sup>	max. 10 s, dip soldering distance to seating plane ≥ 1.5 mm	T <sub>slid</sub>	260	°C

**Notes**

- Stresses in excess of the absolute maximum ratings can cause permanent damage to the device. Functional operation of the device is not implied at these or any other conditions in excess of those given in the operational sections of this document. Exposure to absolute maximum ratings for extended periods of the time can adversely affect reliability.
- <sup>(1)</sup> Refer to reflow profile for soldering conditions for surface mounted devices (SMD). Refer to wave profile for soldering conditions for through hole devices (DIP).

ELECTRICAL CHARACTERISTICS (T <sub>amb</sub> = 25 °C, unless otherwise specified)							
PARAMETER	TEST CONDITION	PART	SYMBOL	MIN.	TYP.	MAX.	UNIT
<b>INPUT</b>							
Forward voltage	I <sub>F</sub> = 60 mA		V <sub>F</sub>		1.25	1.65	V
Reverse current	V <sub>R</sub> = 6 V		I <sub>R</sub>		0.01	10	μA
Capacitance	V <sub>R</sub> = 0 V, f = 1 MHz		C <sub>O</sub>		13		pF
Thermal resistance			R <sub>thja</sub>		750		K/W
<b>OUTPUT</b>							
Collector emitter capacitance	V <sub>CE</sub> = 5 V, f = 1 MHz		C <sub>CE</sub>		5.2		pF
Thermal resistance			R <sub>thja</sub>		500		K/W
Collector emitter leakage current	V <sub>CE</sub> = 10 V	SFH610A-1	I <sub>CEO</sub>		2	50	nA
		SFH6106-1	I <sub>CEO</sub>		2	50	nA
		SFH610A-2	I <sub>CEO</sub>		2	50	nA
		SFH6106-2	I <sub>CEO</sub>		2	50	nA
		SFH610A-3	I <sub>CEO</sub>		5	100	nA
		SFH6106-3	I <sub>CEO</sub>		5	100	nA
		SFH610A-4	I <sub>CEO</sub>		5	100	nA
		SFH6106-4	I <sub>CEO</sub>		5	100	nA
		SFH610A-5	I <sub>CEO</sub>		5	100	nA
SFH6106-5T	I <sub>CEO</sub>		5	100	nA		



**ELECTRICAL CHARACTERISTICS** ( $T_{amb} = 25\text{ }^{\circ}\text{C}$ , unless otherwise specified)

PARAMETER	TEST CONDITION	PART	SYMBOL	MIN.	TYP.	MAX.	UNIT
<b>COUPLER</b>							
Collector emitter saturation voltage	$I_F = 10\text{ mA}$ , $I_C = 2.5\text{ mA}$		$V_{CEsat}$		0.25	0.4	V
Coupling capacitance	$f = 1\text{ MHz}$		$C_C$		0.4		pF

**Note**

- Minimum and maximum values are testing requirements. Typical values are characteristics of the device and are the result of engineering evaluation. Typical values are for information only and are not part of the testing requirements.

**CURRENT TRANSFER RATIO**

PARAMETER	TEST CONDITION	PART	SYMBOL	MIN.	TYP.	MAX.	UNIT
$I_C/I_F$	$I_F = 10\text{ mA}$ , $V_{CE} = 5.0\text{ V}$	SFH610A-1	CTR	40		80	%
		SFH6106-1	CTR	40		80	%
		SFH610A-2	CTR	63		125	%
		SFH6106-2	CTR	63		125	%
		SFH610A-3	CTR	100		200	%
		SFH6106-3	CTR	100		200	%
		SFH610A-4	CTR	160		320	%
		SFH6106-4	CTR	160		320	%
		SFH610A-5	CTR	250		500	%
	SFH6106-5T	CTR	250		500	%	
	$I_F = 1\text{ mA}$ , $V_{CE} = 5\text{ V}$	SFH610A-1	CTR	13	30		%
		SFH6106-1	CTR	13	30		%
		SFH610A-2	CTR	22	45		%
		SFH6106-2	CTR	22	45		%
		SFH610A-3	CTR	34	70		%
		SFH6106-3	CTR	34	70		%
		SFH610A-4	CTR	56	90		%
		SFH6106-4	CTR	56	90		%

**SWITCHING CHARACTERISTICS**

PARAMETER	TEST CONDITION	PART	SYMBOL	MIN.	TYP.	MAX.	UNIT						
<b>NON-SATURATED</b>													
Current	$V_{CC} = 5\text{ V}$ , $R_L = 75\text{ }\Omega$		$I_F$		10		mA						
Rise time	$V_{CC} = 5\text{ V}$ , $R_L = 75\text{ }\Omega$		$t_r$		2		$\mu\text{s}$						
Fall time	$V_{CC} = 5\text{ V}$ , $R_L = 75\text{ }\Omega$		$t_f$		2		$\mu\text{s}$						
Turn-on time	$V_{CC} = 5\text{ V}$ , $R_L = 75\text{ }\Omega$		$t_{on}$		3		$\mu\text{s}$						
Turn-off time	$V_{CC} = 5\text{ V}$ , $R_L = 75\text{ }\Omega$		$t_{off}$		2.3		$\mu\text{s}$						
Cut-off frequency	$V_{CC} = 5\text{ V}$		$F_{CO}$		250		kHz						
<b>SATURATED</b>													
Current		SFH610A-1	$I_F$		20		mA						
		SFH6106-1											
		SFH610A-2	$I_F$					10		mA			
		SFH6106-2											
		SFH610A-3	$I_F$								10		mA
		SFH6106-3											
		SFH610A-4	$I_F$										
SFH6106-4													



SWITCHING CHARACTERISTICS							
PARAMETER	TEST CONDITION	PART	SYMBOL	MIN.	TYP.	MAX.	UNIT
<b>SATURATED</b>							
Rise time		SFH610A-1	$t_r$		2		$\mu\text{s}$
		SFH6106-1					
		SFH610A-2	$t_r$		3		$\mu\text{s}$
		SFH6106-2					
		SFH610A-3	$t_r$		3		$\mu\text{s}$
		SFH6106-3					
SFH610A-4	$t_r$		4		$\mu\text{s}$		
SFH6106-4							
Fall time		SFH610A-1	$t_f$		11		$\mu\text{s}$
		SFH6106-1					
		SFH610A-2	$t_f$		14		$\mu\text{s}$
		SFH6106-2					
		SFH610A-3	$t_f$		14		$\mu\text{s}$
		SFH6106-3					
SFH610A-4	$t_f$		15		$\mu\text{s}$		
SFH6106-4							
Turn-on time		SFH610A-1	$t_{on}$		3		$\mu\text{s}$
		SFH6106-1					
		SFH610A-2	$t_{on}$		4.2		$\mu\text{s}$
		SFH6106-2					
		SFH610A-3	$t_{on}$		4.2		$\mu\text{s}$
		SFH6106-3					
SFH610A-4	$t_{on}$		6		$\mu\text{s}$		
SFH6106-4							
Turn-off time		SFH610A-1	$t_{off}$		18		$\mu\text{s}$
		SFH6106-1					
		SFH610A-2	$t_{off}$		23		$\mu\text{s}$
		SFH6106-2					
		SFH610A-3	$t_{off}$		23		$\mu\text{s}$
		SFH6106-3					
SFH610A-4	$t_{off}$		25		$\mu\text{s}$		
SFH6106-4							

**Note**

- All values presented are typical values.



SAFETY AND INSULATION RATINGS						
PARAMETER	TEST CONDITION	SYMBOL	MIN.	TYP.	MAX.	UNIT
Climatic classification (according to IEC 68 part 1)				55/100/21		
Comparative tracking index		CTI	175		399	
$V_{IOTM}$			10000			V
$V_{IORM}$			890			V
$P_{SO}$					400	mW
$I_{SI}$					275	mA
$T_{SI}$					175	°C
Creepage distance	standard DIP-4		7			mm
Clearance distance	standard DIP-4		7			mm
Creepage distance	400 mil DIP-4		8			mm
Clearance distance	400 mil DIP-4		8			mm
Insulation thickness, reinforced rated	per IEC 60950 2.10.5.1		0.4			mm

**Note**

- As per IEC 60747-5-2, § 7.4.3.8.1, this optocoupler is suitable for "safe electrical insulation" only within the safety ratings. Compliance with the safety ratings shall be ensured by means of protective circuits.

**TYPICAL CHARACTERISTICS** ( $T_{amb} = 25\text{ }^{\circ}\text{C}$ , unless otherwise specified)

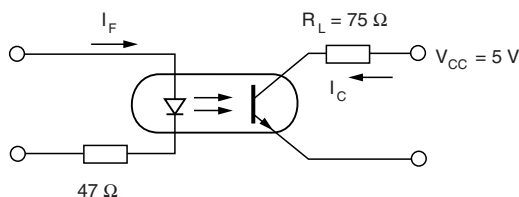

isfh610a\_01

Fig. 1 - Linear Operation (without saturation)

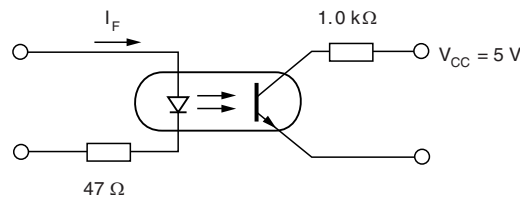

isfh610a\_02

Fig. 3 - Switching Operation (with saturation)

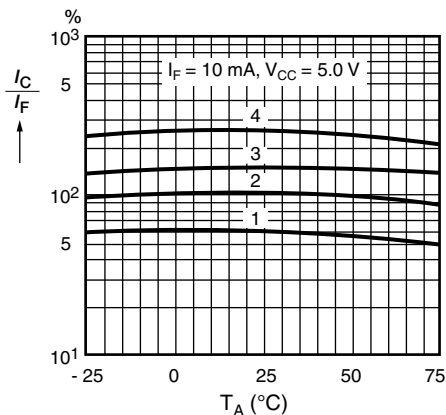

isfh610a\_03

Fig. 2 - Current Transfer Ratio (CTR) vs. Temperature

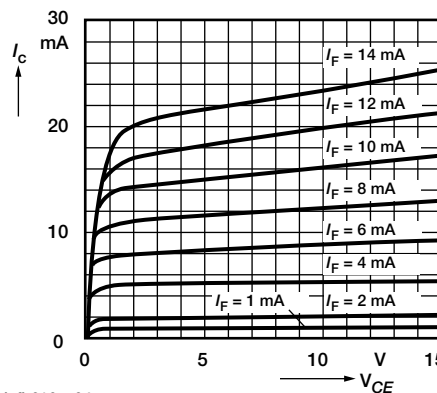

isfh610a\_04

Fig. 4 - Output Characteristics (typ.) Collector Current vs. Collector Emitter Voltage

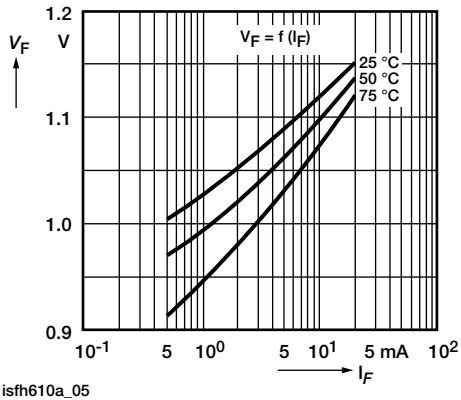

Fig. 5 - Diode Forward Voltage vs. Forward Current

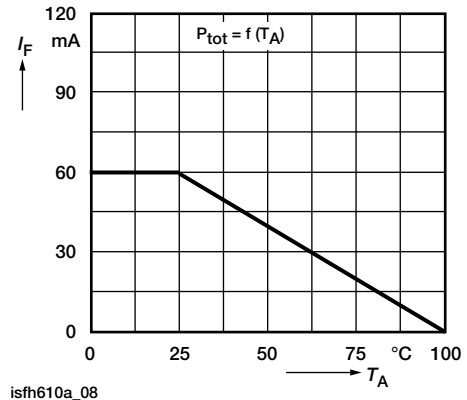

Fig. 8 - Permissible Power Dissipation vs. Temperature

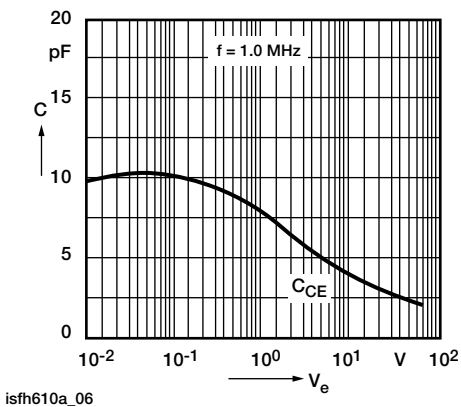

Fig. 6 - Transistor Capacitance (typ.) vs. Collector Emitter Voltage

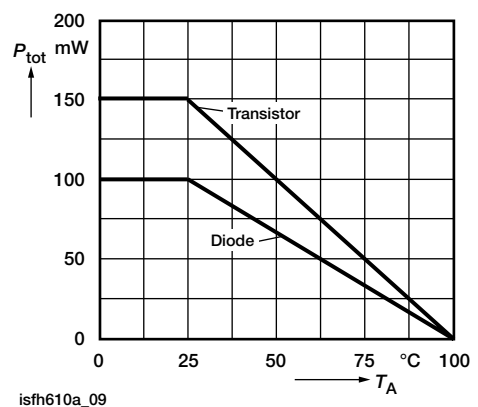

Fig. 9 - Permissible Diode Forward Current vs. Ambient Temperature

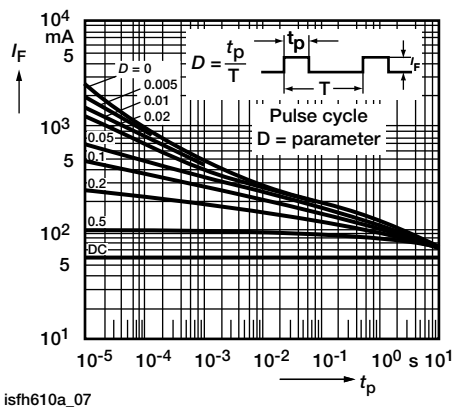
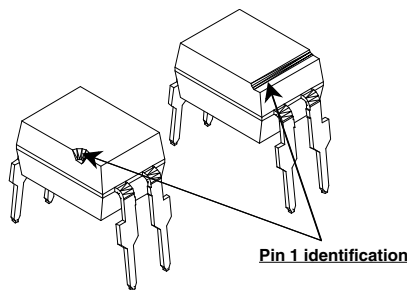
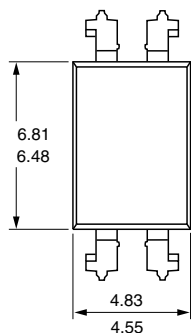

Fig. 7 - Permissible Pulse Handling Capability Forward Current vs. Pulse Width



PACKAGE DIMENSIONS in inches (millimeters)



Pin 1 identification

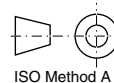
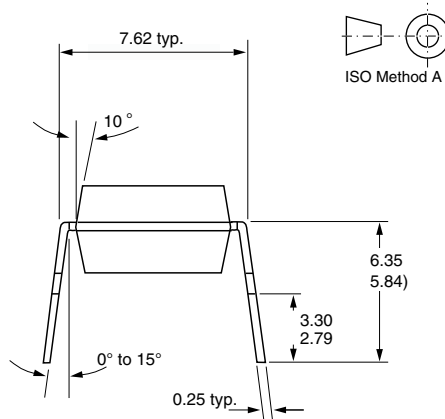
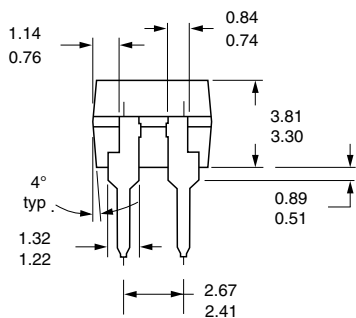

ISO Method A

i178027-1

SMD

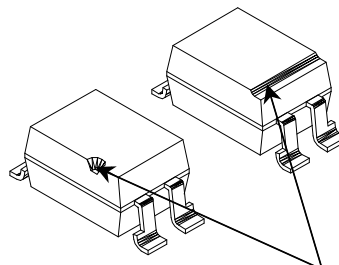
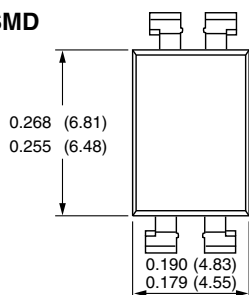

PIN 1 IDENTIFICATION

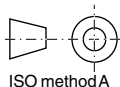
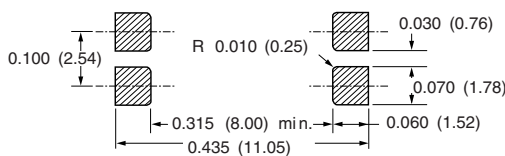

ISO method A

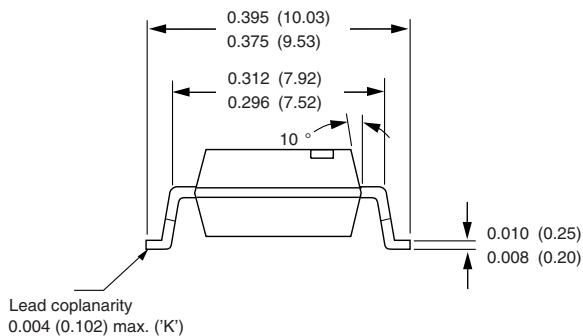
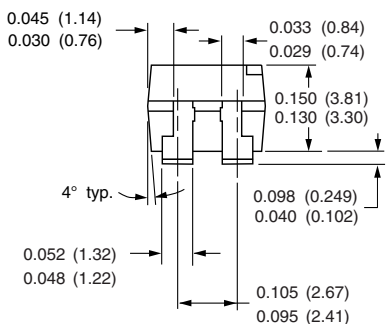

i178029-2



Option 6

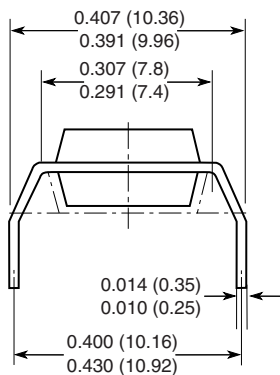

Option 7

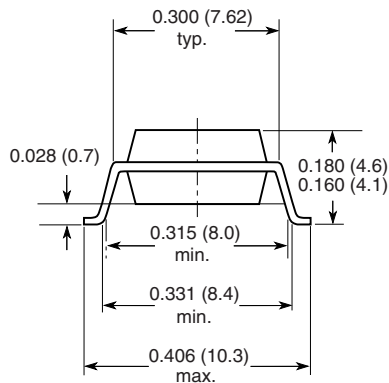

Option 8

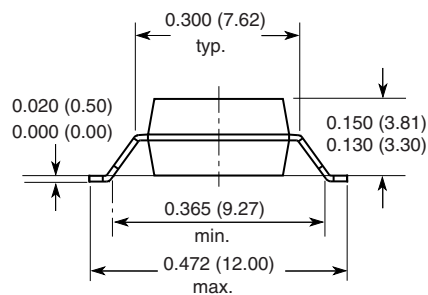

18487





## Disclaimer

ALL PRODUCT, PRODUCT SPECIFICATIONS AND DATA ARE SUBJECT TO CHANGE WITHOUT NOTICE TO IMPROVE RELIABILITY, FUNCTION OR DESIGN OR OTHERWISE.

Vishay Intertechnology, Inc., its affiliates, agents, and employees, and all persons acting on its or their behalf (collectively, "Vishay"), disclaim any and all liability for any errors, inaccuracies or incompleteness contained in any datasheet or in any other disclosure relating to any product.

Vishay makes no warranty, representation or guarantee regarding the suitability of the products for any particular purpose or the continuing production of any product. To the maximum extent permitted by applicable law, Vishay disclaims (i) any and all liability arising out of the application or use of any product, (ii) any and all liability, including without limitation special, consequential or incidental damages, and (iii) any and all implied warranties, including warranties of fitness for particular purpose, non-infringement and merchantability.

Statements regarding the suitability of products for certain types of applications are based on Vishay's knowledge of typical requirements that are often placed on Vishay products in generic applications. Such statements are not binding statements about the suitability of products for a particular application. It is the customer's responsibility to validate that a particular product with the properties described in the product specification is suitable for use in a particular application. Parameters provided in datasheets and/or specifications may vary in different applications and performance may vary over time. All operating parameters, including typical parameters, must be validated for each customer application by the customer's technical experts. Product specifications do not expand or otherwise modify Vishay's terms and conditions of purchase, including but not limited to the warranty expressed therein.

Except as expressly indicated in writing, Vishay products are not designed for use in medical, life-saving, or life-sustaining applications or for any other application in which the failure of the Vishay product could result in personal injury or death. Customers using or selling Vishay products not expressly indicated for use in such applications do so at their own risk. Please contact authorized Vishay personnel to obtain written terms and conditions regarding products designed for such applications.

No license, express or implied, by estoppel or otherwise, to any intellectual property rights is granted by this document or by any conduct of Vishay. Product names and markings noted herein may be trademarks of their respective owners.

## Material Category Policy

**Vishay Intertechnology, Inc. hereby certifies that all its products that are identified as RoHS-Compliant fulfill the definitions and restrictions defined under Directive 2011/65/EU of The European Parliament and of the Council of June 8, 2011 on the restriction of the use of certain hazardous substances in electrical and electronic equipment (EEE) - recast, unless otherwise specified as non-compliant.**

**Please note that some Vishay documentation may still make reference to RoHS Directive 2002/95/EC. We confirm that all the products identified as being compliant to Directive 2002/95/EC conform to Directive 2011/65/EU.**

**Vishay Intertechnology, Inc. hereby certifies that all its products that are identified as Halogen-Free follow Halogen-Free requirements as per JEDEC JS709A standards. Please note that some Vishay documentation may still make reference to the IEC 61249-2-21 definition. We confirm that all the products identified as being compliant to IEC 61249-2-21 conform to JEDEC JS709A standards.**

# Mouser Electronics

Authorized Distributor

Click to View Pricing, Inventory, Delivery & Lifecycle Information:

[Vishay:](#)

[SFH6106-1](#) [SFH6106-2](#) [SFH6106-3](#) [SFH6106-4](#) [SFH610A-1](#) [SFH610A-2](#) [SFH610A-3](#) [SFH610A-4](#) [SFH6106-3T](#)  
[SFH6106-2T](#) [SFH610A-1X001](#) [SFH610A-1X016](#) [SFH610A-2X001](#) [SFH610A-2X006](#) [SFH610A-3X001](#) [SFH610A-](#)  
[3X006](#) [SFH610A-3X007T](#) [SFH610A-3X016](#) [SFH610A-4X001](#) [SFH610A-4X016](#) [SFH6106-1T](#) [SFH6106-1X001](#)  
[SFH6106-1X001T](#) [SFH6106-2X001](#) [SFH6106-2X001T](#) [SFH6106-3X001](#) [SFH6106-3X001T](#) [SFH6106-4T](#) [SFH6106-](#)  
[4X001](#) [SFH6106-4X001T](#) [SFH6106-5T](#)