



# 4-in-1 Video Decoders with PCI Express Media Bridge

## TW6865

The TW6865 is a highly integrated solution that supports multi-channel video and audio capture via PCIe x1 interface for PC DVR system and video analytic application. It contains high quality four-channel NTSC/PAL/SECAM video decoders that convert analog composite video signal to digital component YCbCr data, and utilize adaptive 4H comb filter for separating luminance and chrominance to reduce cross noise artifacts.

TW6865 contains a high performance proprietary DMA controller that fully optimizes the utilization of PCIe x1 bandwidth and enables it to transfer video and audio data at a high throughput rate that closely approaches the theoretical limit of PCIe1 interface. TW6865 is able to simultaneously decode and transfer 4 real time D1 video, or up to 16 channel non-real time D1, plus 8 channel audio.

TW6865 decreases the complexity and workload of client-side software development, and significantly reduces the strains on PC hardware and resources. TW6865 also includes a software development kit (SDK) with Windows and Linux compliant drivers and reference application software.

## Features

### Video Decoders

- Accepts all NTSC(M/N/4.43) / PAL(B/D/G/H/I/K/L/M/N/60) standards with auto detection
- Integrated eight video analog anti-alias filters and 10-bit CMOS ADCs
- IF compensation filter for improvement of color demodulation
- Color Transient Improvement (CTI)
- White peak AGC control
- Programmable hue, saturation, contrast, brightness and sharpness
- High quality proprietary fast video locking system for non-real-time application
- High performance adaptive 4H comb filters for all NTSC and PAL standards

### Audio Codecs

- Integrated eight audio ADCs
- 8/16 bit audio word length
- Sample audio with 8/16/32/44.1/48kHz

### DMA Controller

- Highly-efficient DMA design can support up to 4 real time D1 video and 8 real time audio channels, or up to 16 non-real-time video with optimization of full PCIe1 bandwidth
- Multiple video format output support: UYVY/Y422, YUYV/YUY2, IYU1/Y411, Y41P, YUV420, RGB555 and RGB565
- Integrated internal video and audio generator simplifies system test and development
- Built-in motion detection engine for each video channel
- Hardware-friendly design enables smooth data transfer and virtually eliminates unwanted big-block data jamming among PC devices, resulting in optimized PC internal bandwidth consumption
- PCIe Configurations
- PCI Express Base Specification 1.1 Compliant
- Flexible PCIe packet size configuration: 128 byte, 256 byte and 512 byte options

## Applications

- PC-based DVR system
- Video analytic system

# Block Diagram

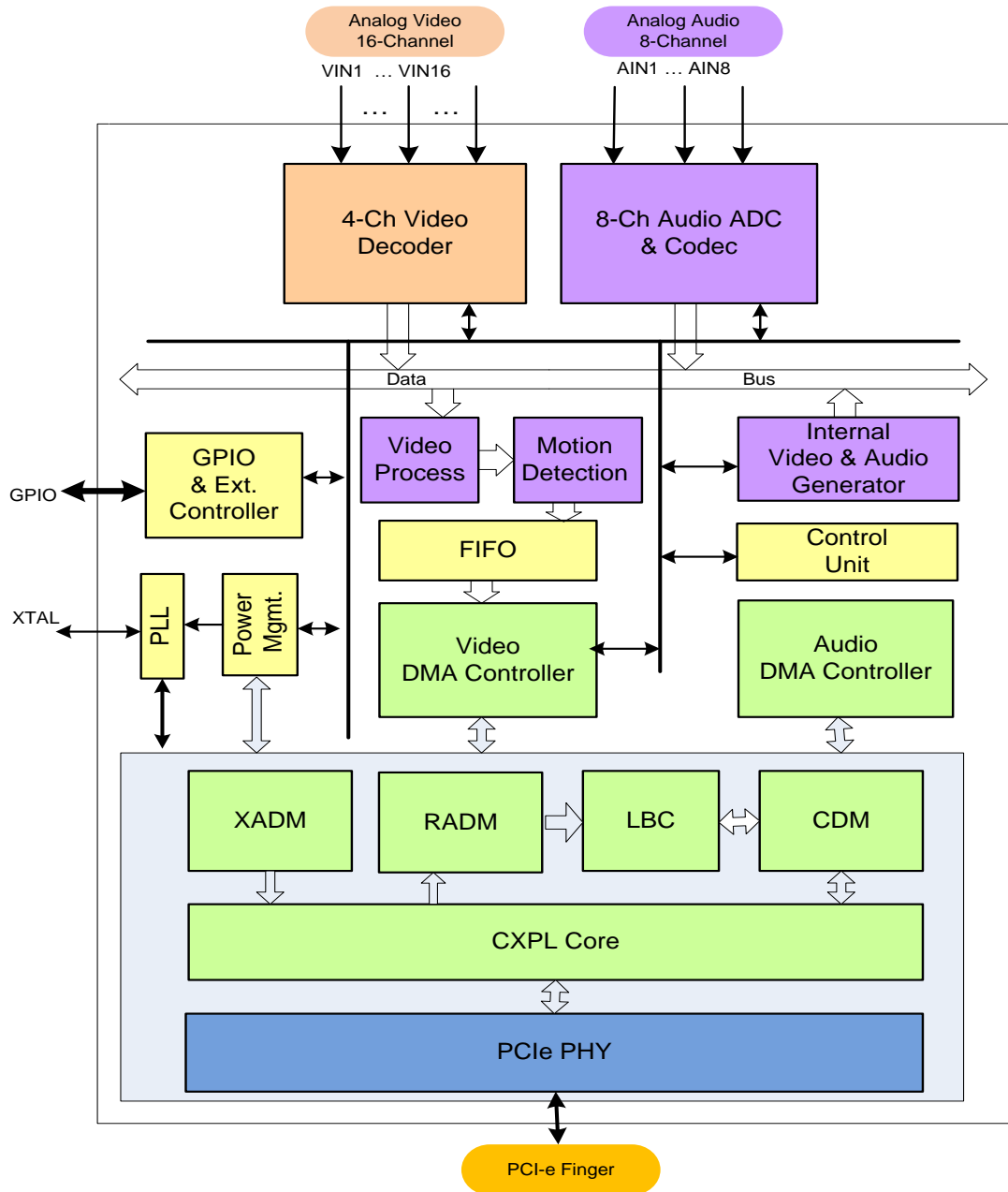

## Pin Descriptions

### Analog Interface Pins (24)

NAME	NUMBER	TYPE	DESCRIPTION
VIN1A	139	A	Composite video inputs
VIN1B	140	A	Composite video inputs
VIN1C	141	A	Composite video inputs
VIN1D	142	A	Composite video inputs
VIN2A	4	A	Composite video inputs
VIN2B	3	A	Composite video inputs
VIN2C	2	A	Composite video inputs
VIN2D	1	A	Composite video inputs
VIN3A	7	A	Composite video inputs
VIN3B	8	A	Composite video inputs
VIN3C	9	A	Composite video inputs
VIN3D	10	A	Composite video inputs
VIN4A	16	A	Composite video inputs
VIN4B	15	A	Composite video inputs
VIN4C	14	A	Composite video inputs
VIN4D	13	A	Composite video inputs
AIN1	133	A	Analog audio inputs
AIN2	134	A	Analog audio inputs
AIN3	135	A	Analog audio inputs
AIN4	136	A	Analog audio inputs
AIN5	48	A	Analog audio inputs
AIN6	47	A	Analog audio inputs
AIN7	46	A	Analog audio inputs
AIN8	45	A	Analog audio inputs

### PCI Express Interface (7)

NAME	NUMBER	TYPE	DESCRIPTION
TX_M	87	0	High-Speed Differential Transmit Pair
TX_P	88	0	
RX_P	90	1	High-Speed Differential Receive Pair

## TW6865

NAME	NUMBER	TYPE	DESCRIPTION
RX_M	91	I	
REXT	93	IO	Reference Resistor Connection. 190Ω 1% precision resistor to ground
REFCLK_P	95	I	Differential Reference Clock Input
REFCLK_M	96	I	

### System Control Pins (50)

NAME	NUMBER	TYPE	DESCRIPTION
XTALI	109	IO	System reference clock crystal input (27MHz)
XTALO	110	IO	System reference clock crystal output
PERST_N	84	I	System reset.
TEST[1:0]	53,52	I	Test mode selection, tie to ground
GPIO[42:0]	129,128,127,126,125, 124,123,122,121,118, 117,116,115,114,113, 108,107,106,105,104, 103,102,101,81,80,79, 78,77,76,75,70,69,68, 67,66,65,64,63,62,59, 58,57,56	IO	GPIO control ports
T_SEL	54	I	NC
R_SEL	55	I	NC

### Power / Ground Pins (47)

NAME	NUMBER	TYPE	DESCRIPTION
VP	85,98	P	Low-Voltage Supply (1.2V)
VPH	86,97	P	High-Voltage I/O Supply (3.3V)
GD	89,92,94	G	Digital Ground
VDD33	51,71,82,100,119	P	Digital I/O Power, 3.3V
VSS33	50,72,83,99,120	G	Digital Ground
VDD12	19,61,74,111,131	P	Digital Core Power, 1.2V
VSS12	18,60,73,112,130	G	Digital Core Ground
VDDA	132,49	P	Analog Power for Audio ADC, 3.3V
VSSA	137,44	G	Analog Ground for Audio ADC
VDDV	138,5,6,17,20,31,32,43	P	Analog Power for Video ADC, 3.3V
VSSV	143,144,11,12,25,26,37,38	G	Analog Ground for Video ADC

# Pin Configuration

## 144 TQFP Pin Diagram (Top -> Bottom View)

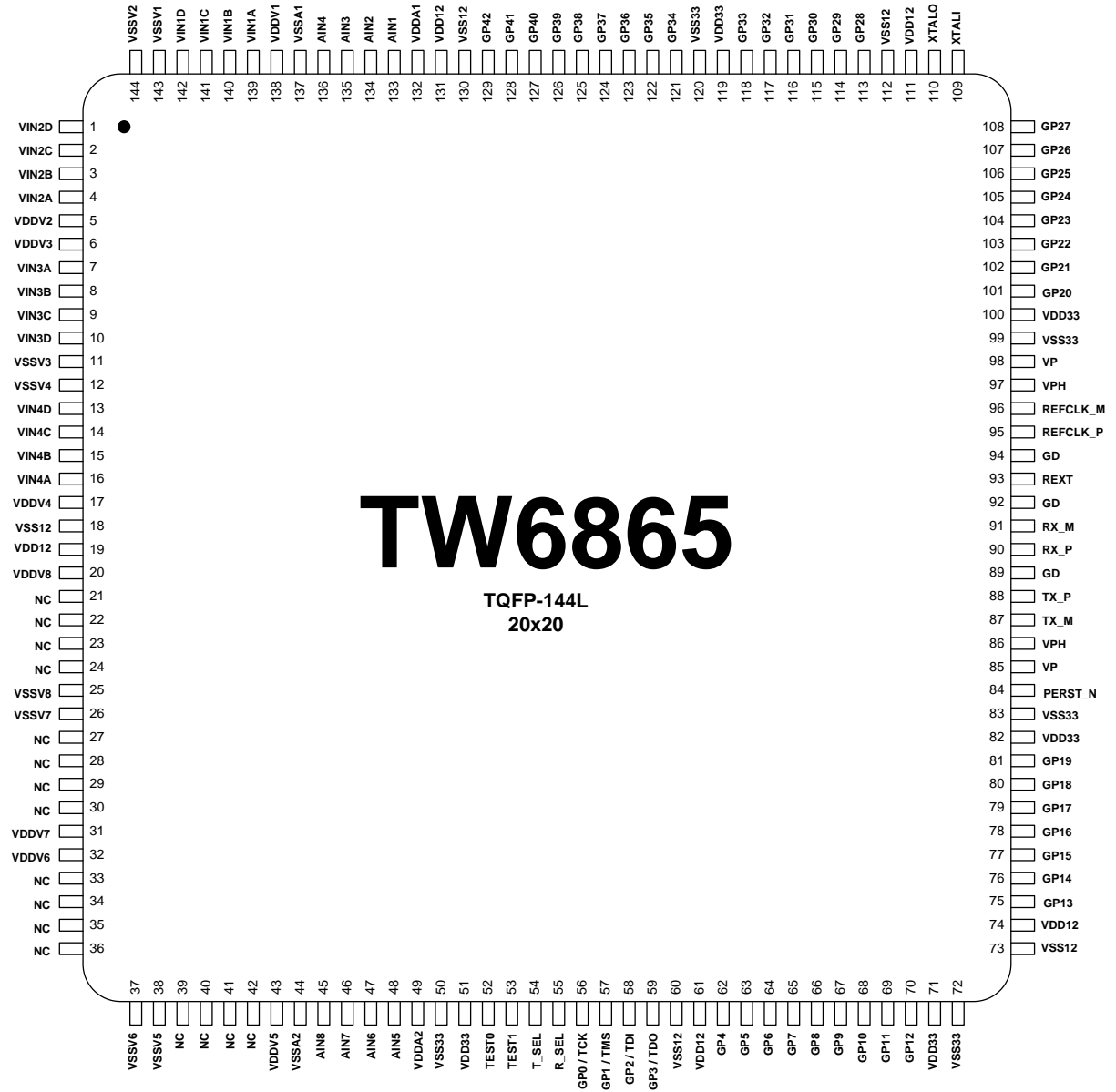

# TW6865

## Ordering Information

PART NUMBER (NOTE 1)	PART MARKING	PACKAGE (PB-FREE)	PKG. DWG. #
TW6865-TA1-CR	TW6865 TA1-CR	144 LEAD TQFP (20mmx20mm)	Q144.20X20C

NOTE:

1. These Intersil Pb-free plastic packaged products employ special Pb-free material sets, molding compounds/die attach materials, and 100% matte tin plate plus anneal (e3 termination finish, which is RoHS compliant and compatible with both SnPb and Pb-free soldering operations). Intersil Pb-free products are MSL classified at Pb-free peak reflow temperatures that meet or exceed the Pb-free requirements of IPC/JEDEC J STD-020.

## **Table of Contents**

<b>Video Decoder .....</b>	<b>8</b>
Video Input Formats .....	8
Analog Frontend .....	9
Decimation Filter .....	10
Automatic Gain Control and Clamping.....	11
Sync Processing .....	11
Y/C Separation .....	11
Color Decoding .....	13
Chrominance Demodulation .....	13
ACC (Automatic Color Gain Control) .....	13
Chrominance Processing.....	13
Chrominance Gain, Offset and Hue Adjustment.....	13
CTI (Color Transient Improvement) .....	14
Luminance Processing.....	14
Video Cropping .....	14
Video Scaler .....	15
<b>Audio Codec.....</b>	<b>18</b>
Audio Detection.....	18
<b>DMA Controller .....</b>	<b>19</b>
<b>Internal Video &amp; Audio Generator .....</b>	<b>19</b>
<b>Control Unit .....</b>	<b>19</b>
<b>GPIO &amp; Ext. Controller .....</b>	<b>19</b>
<b>PCI Express EndPoint Controller .....</b>	<b>19</b>
<b>PCI Express PHY .....</b>	<b>19</b>
<b>Host Interface .....</b>	<b>19</b>
<b>Register Description .....</b>	<b>20</b>
DMA Controller .....	20
Video Decoder & Audio Codec (CH0 ~ CH3).....	64
PCIe Endpoint Controller.....	92
<b>Parametric Information .....</b>	<b>108</b>
<b>Absolute Maximum Ratings .....</b>	<b>108</b>
<b>Recommended Operating Conditions .....</b>	<b>108</b>
<b>DC Electrical Parameters.....</b>	<b>108</b>
<b>Supply Current and Power Dissipation .....</b>	<b>109</b>
<b>Video Decoder Parameter 1.....</b>	<b>109</b>
<b>Video Decoder Parameter 2.....</b>	<b>110</b>
<b>Analog Audio Parameters .....</b>	<b>111</b>
<b>Audio Decimation Filter Response .....</b>	<b>112</b>
<b>Application Schematic.....</b>	<b>113</b>
<b>Package Dimension .....</b>	<b>114</b>
<b>Revision History.....</b>	<b>115</b>

## Functional Description

### Video Decoder

#### VIDEO INPUT FORMATS

The TW6865 has built-in automatic standard discrimination circuitry. The circuit uses burst-phase, burst-frequency and frame rate to identify NTSC, PAL or SECAM color signals. The standards that can be identified are NTSC (M), NTSC (4.43), PAL (B, D, G, H, I), PAL (M), PAL (N), PAL (60) and SECAM (M). Each standard can be included or excluded in the standard recognition process by software control. The exceptions are the base standard NTSC and PAL, which are always enabled. The identified standard is indicated by the Standard Selection (SDT) register. Automatic standard detection can be overridden by software controlled standard selection.

TW6865 supports all common video formats as shown in Table 1.

**TABLE 1. VIDEO INPUT FORMATS SUPPORTED BY THE TW6865**

FORMAT	LINES	FIELDS	FSC	COUNTRY
NTSC-M	525	60	3.579545MHz	U.S., many others
NTSC-Japan (Note 0)	525	60	3.579545MHz	Japan
PAL-B, G, N	625	50	4.433619MHz	Many
PAL-D	625	50	4.433619MHz	China
PAL-H	625	50	4.433619MHz	Belgium
PAL-I	625	50	4.433619MHz	Great Britain, others
PAL-M	525	60	3.575612MHz	Brazil
PAL-CN	625	50	3.582056MHz	Argentina
SECAM	625	50	4.406MHz 4.250MHz	France, Eastern Europe, Middle East, Russia
PAL-60	525	60	4.433619MHz	China
NTSC (4.43)	525	60	4.433619MHz	Transcoding

NOTE:

NTSC-Japan has 0 IRE setup.



## ANALOG FRONTEND

The TW6865 contains four 10-bit ADC (Analog to Digital Converters) to digitize the analog video inputs. The ADC can be put into power-down mode by the V\_ADC\_PWDN register. The TW6865 also contains an anti-aliasing filter to prevent out-of-band frequency in analog video input signal. Therefore, there is no need for external components in the analog input pin except for an AC coupling capacitor and a termination resistor. Figure 1 shows the frequency response of the anti-aliasing filter.

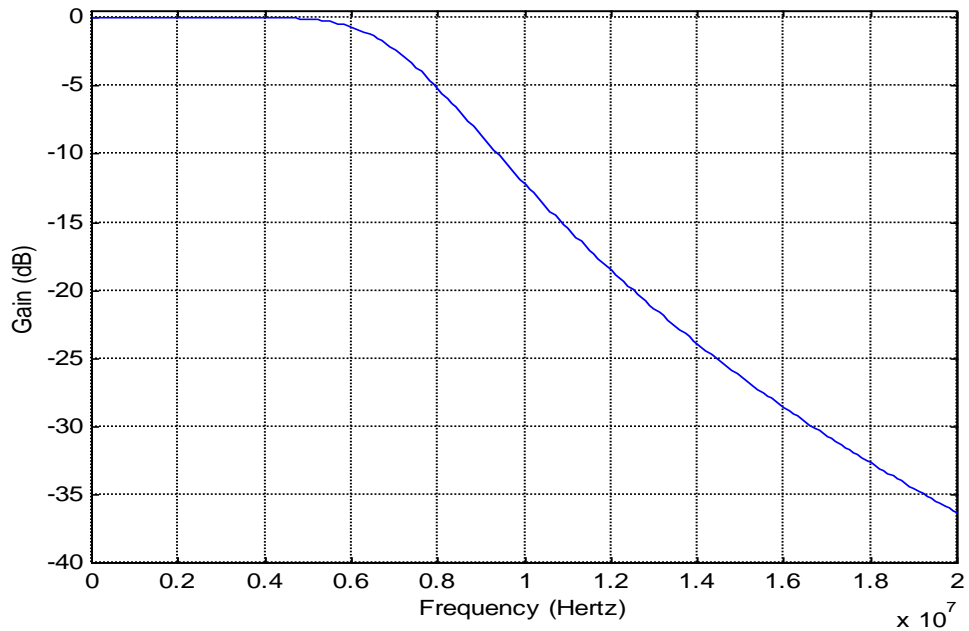
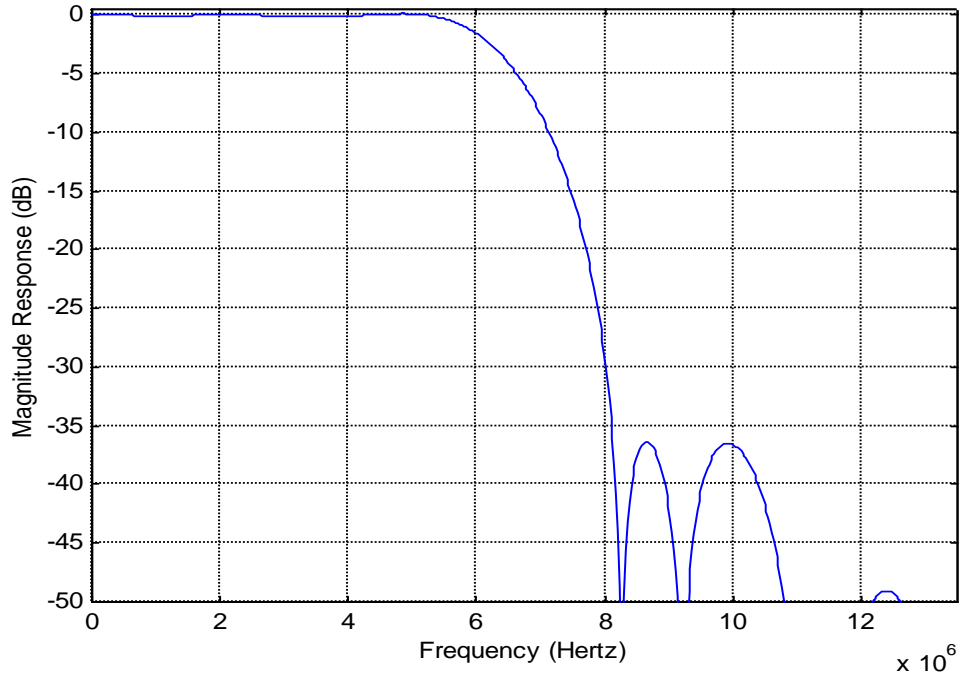

FIGURE 1. THE FREQUENCY RESPONSE OF ANTI-ALIASING FILTER

**DECIMATION FILTER**

The digitized composite video data is over-sampled to simplify the design of the analog filter. The decimation filter is required to achieve optimum performance and prevent high frequency components from being aliased back into the video image when down-sampled. Figure 2 shows the characteristic of the decimation filter.



**FIGURE 2. THE CHARACTERISTIC OF THE DECIMATION FILTER**

## **AUTOMATIC GAIN CONTROL AND CLAMPING**

All four analog channels have built-in clamping circuits that restore the signal DC level. The Y channel restores the back porch of the digitized video to a level of 60. This operation is automatic through internal feedback loop. The Automatic Gain Control (AGC) of the Y channel adjusts input gain so that the sync tip is at a desired level. Programmable white peak protection logic is included to prevent saturation in the case of abnormal signal proportion between sync and white peak level.

## **SYNC PROCESSING**

The sync processor of TW6865 detects horizontal synchronization and vertical synchronization signals in the composite video or in the Y signal of an S-video or component signal. The processor contains a digital phase-locked-loop and decision logic to achieve reliable sync detection in stable signal as well as in unstable signals, such as those from VCR fast forward or backward.

The vertical sync separator detects the vertical synchronization pattern in the input video signals. In addition, the actual sync determination is controlled by a detection window to provide more reliable synchronization. An option is available to provide faster responses for certain applications. The field status is determined at vertical synchronization time. The field logic can also be controlled to toggle automatically while tracking the input.

## **Y/C SEPARATION**

The color-decoding block contains the luma/chroma separation for the composite video signal and multi-standard color demodulation. For NTSC and PAL standard signals, the luma/chroma separation can be done either by comb filter or notch/band-pass filter combination. For SECAM standard signals, adaptive notch/band-pass filter is used. The default selection for NTSC/PAL is comb filter.

In the case of comb filter, the TW6865 separates luma (Y) and chroma (C) of a NTSC/PAL composite video signal using a proprietary 4H adaptive comb filter. The filter uses a four-line buffer. Adaptive logic combines the upper-comb and the lower-comb results based on the signal changes among the previous, current and next lines. This technique leads to excellent Y/C separation with small cross luma and cross color at both horizontal and vertical edges

Due to the line buffer used in the comb filter, there are always two lines processing delay at the output except for the component input mode, which has only one line delay.

If notch/band-pass filter is selected, the characteristics of the filters are shown in the filter curve section.

Figure 3 shows the frequency response of the notch filter for each system NTSC and PAL. Figure 4 shows the frequency response of Chroma Band Pass Filter Curves.

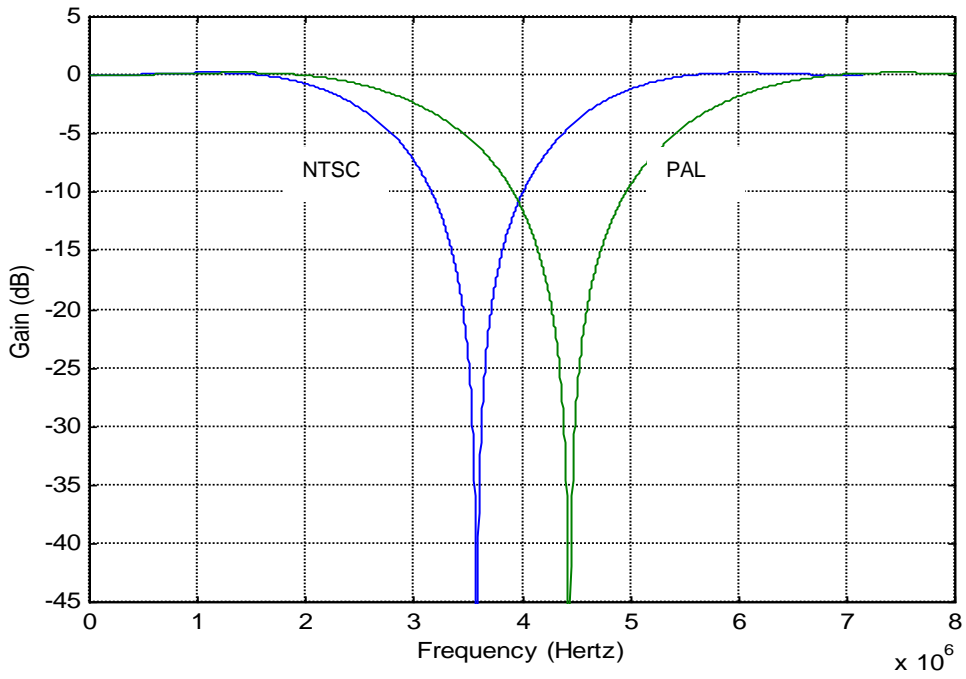

FIGURE 3. THE CHARACTERISTICS OF LUMINANCE NOTCH FILTER FOR PAL

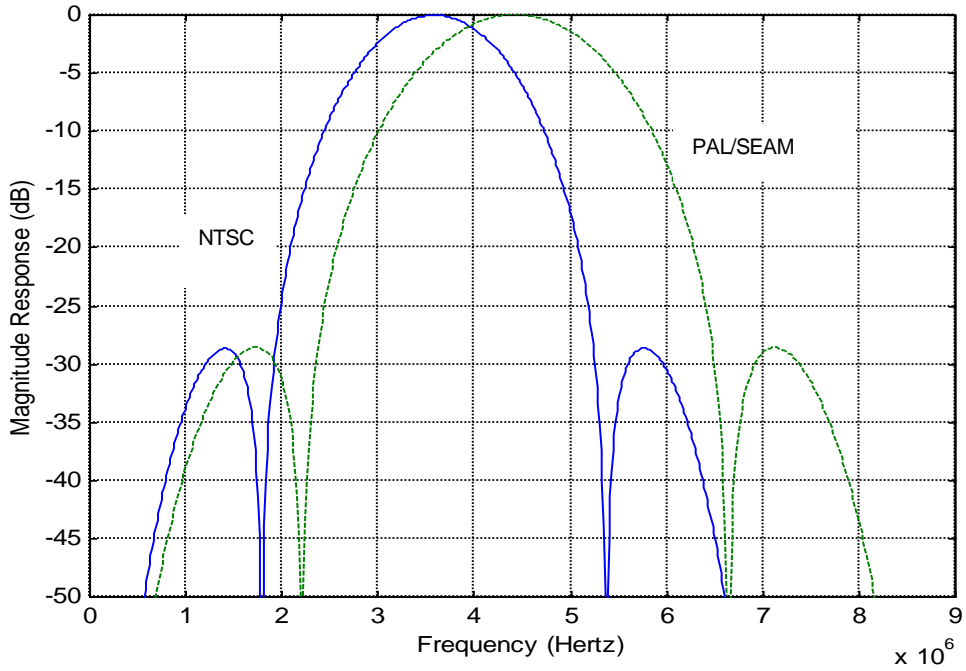

FIGURE 4. CHROMA BAND PASS FILTER CURVES

**COLOR DECODING**

**Chrominance Demodulation**

The color demodulation for NTSC and PAL standard is done by first quadrature mixing the chroma signal to the base band. A low-pass filter is then used to remove carrier signal and yield chroma components. The low-pass filter characteristic can be selected for optimized transient color performance. For the PAL system, the PAL ID or the burst phase switching is identified to aid the PAL color demodulation.

For SECAM, the color information is FM modulated onto a different carrier. The demodulation process therefore consists of FM demodulator and de-emphasis filter. During the FM demodulation, the chroma carrier frequency is identified and used to control the SECAM color demodulation.

The sub-carrier signal for use in the color demodulator is generated by direct digital synthesis PLL that locks onto the input sub-carrier reference (color burst). This arrangement allows any sub-standard of NTSC and PAL to be demodulated easily with single crystal frequency.

Figure 5 shows the frequency response of Chrominance Low-Pass Filter Curves.

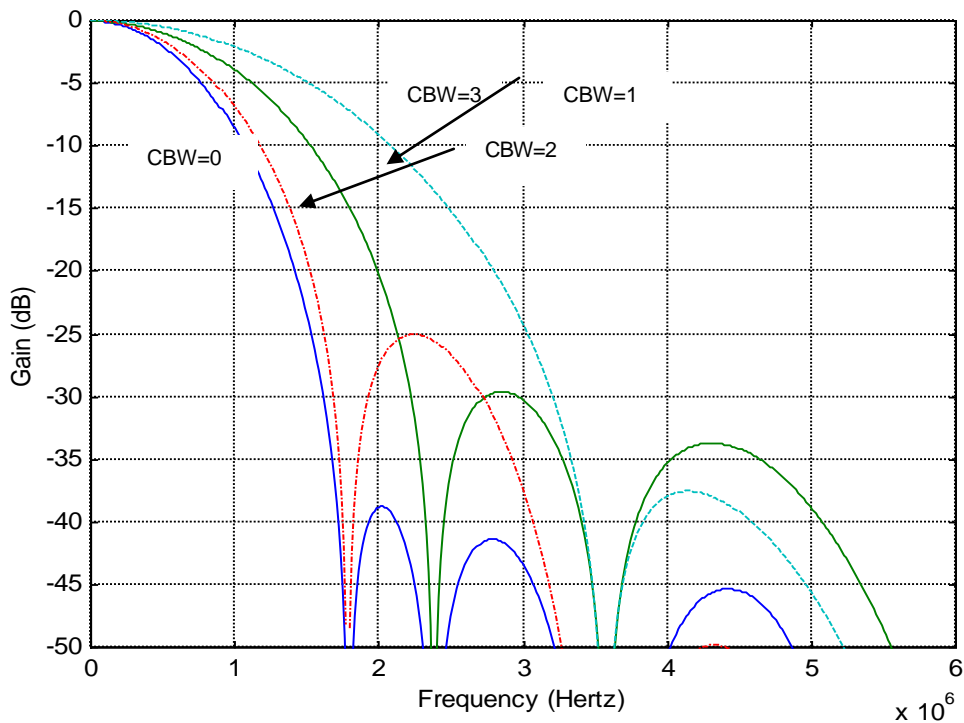

FIGURE 5. CHROMINANCE LOW-PASS FILTER CURVES

**ACC (Automatic Color Gain Control)**

The Automatic Chroma Gain Control (ACC) compensates for reduced amplitudes caused by high-frequency loss in video signal. In the NTSC/PAL standard, the color reference signal is the burst on the back porch. It is measured to control the chroma output gain. The range of ACC control is -6db to +24db.

**CHROMINANCE PROCESSING**

**Chrominance Gain, Offset and Hue Adjustment**

When decoding NTSC signals, TW6865 can adjust the hue of the chroma signal. The hue is defined as a phase shift of the subcarrier with respect to the burst. This phase shift of NTSC decoding can be programmed through a control register. For the PAL standard, the PAL delay line is provided to compensate any hue error;

therefore, there is no hue adjustment available. The color saturation can be adjusted by changing the gain of Cb and Cr signals for all NTSC, PAL and SECAM formats. The Cb and Cr gain can be adjusted independently for flexibility.

## CTI (Color Transient Improvement)

The TW6865 provides the Color Transient Improvement function to further enhance the image quality. The CTI enhance the color edge transient without any overshoot or under-shoot.

## LUMINANCE PROCESSING

The TW6865 adjusts brightness by adding a programmable value (in register BRIGHTNESS) to the Y signal. It adjusts the picture contrast by changing the gain (in register CONTRAST) of the Y signal.

The TW6865 also provide programmable peaking function to further enhance the video sharpness. The peaking control has built-in coring function to prevent enhancement of noise.

Figure 6 shows the characteristics of the peaking filter for four different gain modes and different center frequencies.

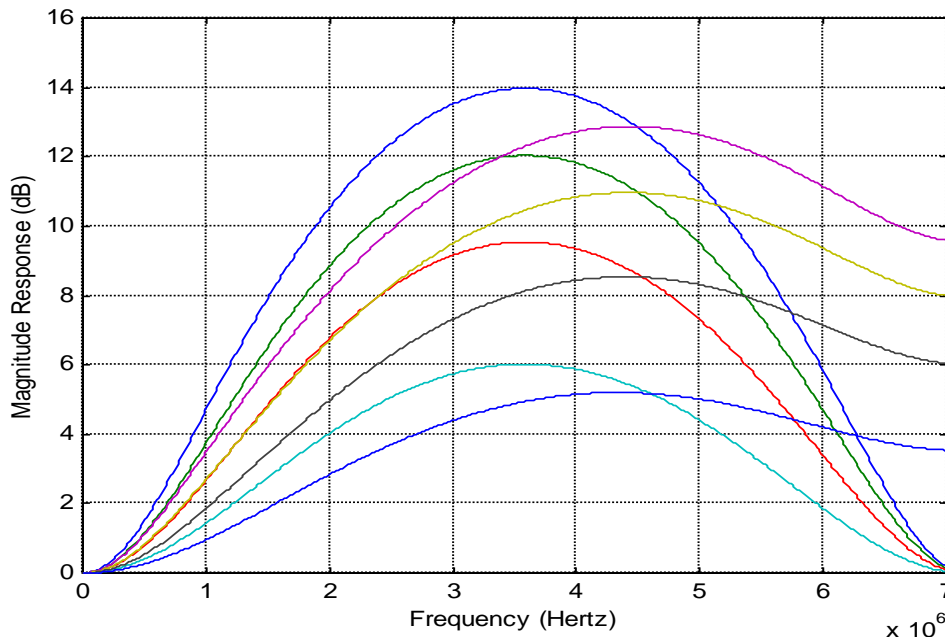

FIGURE 6. THE CHARACTERISTIC OF LUMINANCE PEAKING FILTER

## VIDEO CROPPING

Cropping allows only subsection of a video image to be output. The active video region is determined by HDELAY, HACTIVE, VDELAY and VACTIVE register as illustrated in Figure 6. The VACTIVE signal can be programmed to indicate the number of active lines to be displayed in a video field, and the HACTIVE signal can be programmed to indicate the number of active pixels to be displayed in a video line. The start of the field or frame in the vertical direction is indicated by the leading edge of VSYNC. The start of the line in the horizontal direction is indicated by the leading edge of the HSYNC. The start of the active lines from vertical sync edge is indicated by the VDELAY register. The start of the active pixels from the horizontal edge is indicated by the HDELAY register. The sizes and location of the active video are determined by HDELAY, HACTIVE, VDELAY, and VACTIVE registers. These registers are 8-bit wide, the lower 8-bits is, respectively, in HDELAY\_LO, HACTIVE\_LO, VDELAY\_LO, and VACTIVE\_LO. Their upper 2-bit shares the same register CROP\_HI.

The Horizontal delay register (HDELAY) determines the number of pixels delay between the leading edge of HSYNC and the leading edge of the HACTIVE. Note that this value is referenced to the un-scaled pixel number. The Horizontal active register (HACTIVE) determines the number of active pixels to be output or scaled after the delay from the sync edge is met. This value is also referenced to the un-scaled pixel number. Therefore, if

# TW6865

the scaling ratio is changed, the active video region used for scaling remain unchanged as set by the HACTIVE register, but the valid pixels output are equal or reduced due to down scaling. In order for the cropping to work properly, the following equation should be satisfied.

$$HDELAY + HACTIVE < \text{Total number of pixels per line}$$

For NTSC output at 13.5MHz pixel rate, the total number of pixels is 858. For PAL output at 13.5MHz rate, the total number of pixels is 864. HACTIVE should be set to 720.

The Vertical delay register (VDELAY) determines the number of lines delay between the leading edge of the VSYNC and the start of the active video lines. It indicates number of lines to skip at the start of a frame before asserting the VACTIVE signal. This value is referenced to the incoming scan lines before the vertical scaling. The number of scan lines is 525 for the 60Hz systems and 625 for the 50Hz systems. The Vertical active register (VACTIVE) determines the number of lines to be used in the vertical scaling. Therefore, the number of scan lines output is equal or less than the value set in this register depending on the vertical scaling ratio. In order for the vertical cropping to work properly, the following equation should be observed.

$$VDELAY + VACTIVE < \text{Total number of lines per field}$$

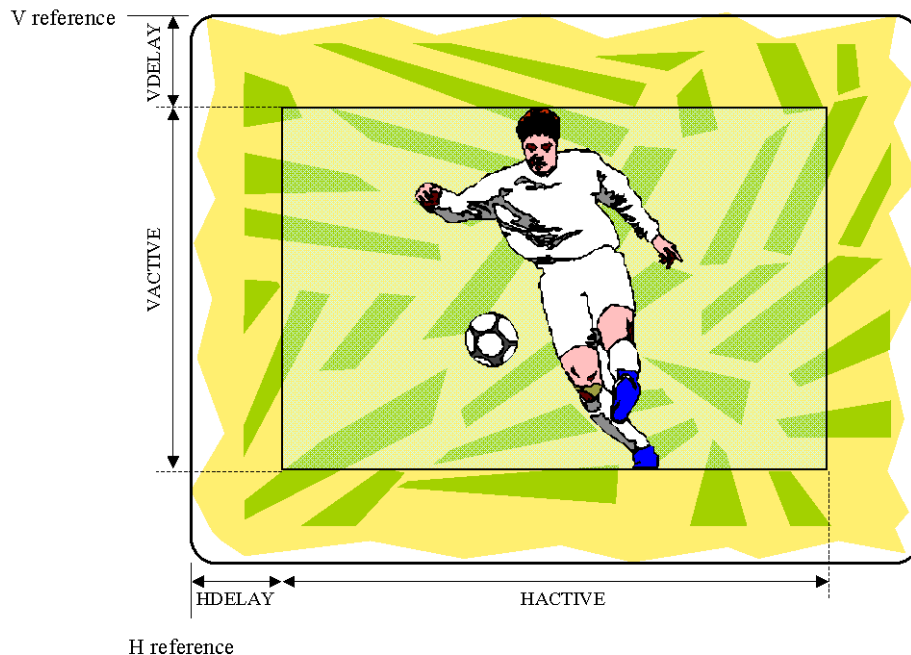

FIGURE 7. THE EFFECT OF CROPPING REGISTERS

## VIDEO SCALER

The TW6865 can independently reduce the output video image size in both horizontal and vertical directions using arbitrary scaling ratios up to 1/16 in each direction. The horizontal scaling employs a dynamic 6-tap 32-phase interpolation filter for luma and a 2-tap 8-phase interpolation filter for chroma because of the limited bandwidth of the chroma data. The vertical scaling uses simple line dropping algorithm. Therefore, the use of non-integer vertical scaling ration is not recommended.

Downscaling is achieved by programming the horizontal scaling ratio register (HSCALE) and vertical scaling ratio register (VSCALE). When outputting unscaled video, the TW6865 will output CCIR601 compatible 720 pixels per line or any number of pixels per line as specified by the HACTIVE register. The standard output for Square Pixel mode is 640 pixels for 60Hz system and 768 pixels for 50Hz systems. If the number of output pixels required is smaller than 720 in CCIR601 compatible mode or the number specified by the HACTIVE

## TW6865

register, the 12-bit HSCALE register, which is the concatenation of two 8-bit registers SCALE\_HI and HSCALE\_LO, is used to reduce the output pixels to the desired number.

Following is an example using pixel ratio to determine the horizontal scaling ratio. These equations should be used to determine the scaling ratio to be written into the 12-bit HSCALE register assuming HACTIVE is programmed with 720 active pixels per line:

$$\text{NTSC:} \quad \text{HSCALE} = \lceil 720 / N_{\text{pixel\_desired}} \rceil * 256$$

$$\text{PAL:} \quad \text{HSCALE} = \lceil (720 / N_{\text{pixel\_desired}}) \rceil * 256$$

Where:  $N_{\text{pixel\_desired}}$  is the nominal number of pixel per line.

For example, to output a CCIR601 compatible NTSC stream at SIF resolution, the HSCALE value can be found as:

$$\text{HSCALE} = \lceil (720 / 320) \rceil * 256 = 576 = 0x0240$$

However, to output a SQ compatible NTSC stream at SIF resolution, the HSCALE value should be found as:

$$\text{HSCALE} = \lceil (640 / 320) \rceil * 256 = 512 = 0x200$$

In this case, with total resolution of 768 per line, the HACTIVE should have a value of 640.

The vertical scaling determines the number of vertical lines output by the TW6865. The vertical scaling register (VSCALE) is a 12-bit register, which is the concatenation of a 4-bit register SCALE\_HI and an 8-bit register VSCALE\_LO. The maximum scaling ratio is 16:1. The following equations should be used to determine the scaling ratio to be written into the 12-bit VSCALE register assuming VACTIVE is programmed with 240 or 288 active lines per field.

$$60\text{Hz system:} \quad \text{VSCALE} = \lceil 240 / N_{\text{line\_desired}} \rceil * 256$$

$$50\text{Hz system:} \quad \text{VSCALE} = \lceil 288 / N_{\text{line\_desired}} \rceil * 256$$

Where:  $N_{\text{line\_desired}}$  is the number of active lines output per field.

The scaling ratios for some popular formats are listed in Table 2. Figure 8 shows the Horizontal Scaler Pre-Filter Curve.

TABLE 2. HSCALE AND VSCALE VALUE FOR SOME POPULAR VIDEO FORMATS.

SCALING RATIO	FORMAT	TOTAL RESOLUTION	OUTPUT RESOLUTION	HSCALE VALUES	VSCALE (FRAME)
1:1	NTSC SQ	780x525	640x480	0x0100	0x0100
	NTSC CCIR601	858x525	720x480	0x0100	0x0100
	PAL SQ	944x625	768x576	0x0100	0x0100
	PAL CCIR601	864x625	720x576	0x0100	0x0100
2:1 (CIF)	NTSC SQ	390x262	320x240	0x0200	0x0200
	NTSC CCIR601	429x262	360x240	0x0200	0x0200
	PAL SQ	472x312	384x288	0x0200	0x0200
	PAL CCIR601	432x312	360x288	0x0200	0x0200
4:1 (QCIF)	NTSC SQ	195x131	160x120	0x0400	0x0400
	NTSC CCIR601	214x131	180x120	0x0400	0x0400
	PAL SQ	236x156	192x144	0x0400	0x0400
	PAL CCIR601	216x156	180x144	0x0400	0x0400



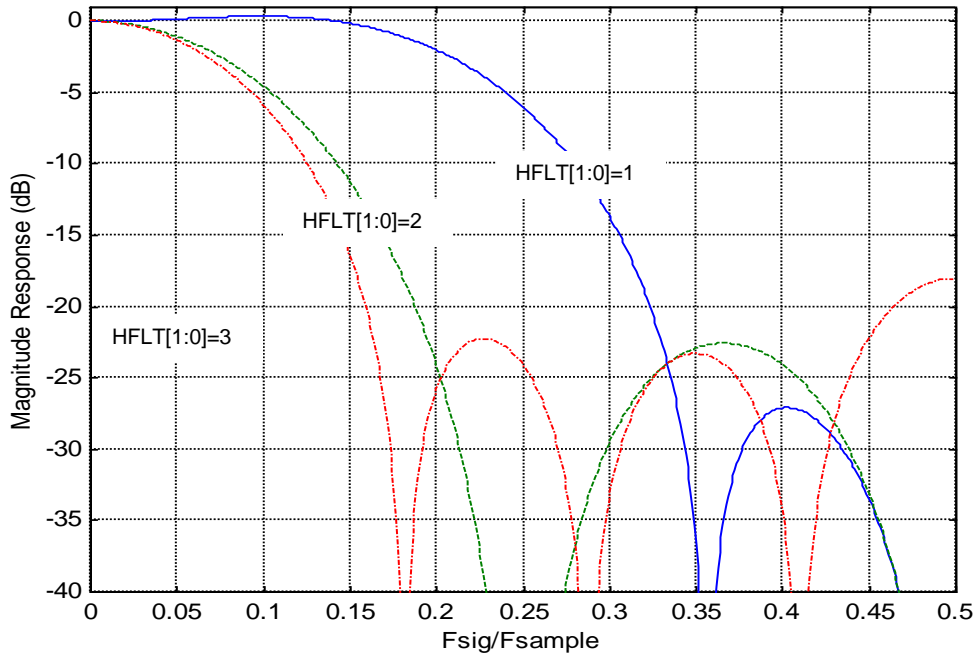

FIGURE 8. HORIZONTAL SCALER PRE-FILTER CURVES

## **Motion Detection**

The TW6865 supports a motion detector for each of the 8 video decoders. The built-in motion detection algorithm uses the difference of luminance level between current and the reference field. To detect motion properly according to situation needed, the TW6865 provides several sensitivity and velocity control parameters for each motion detector. The TW6865 supports manual strobe function to update motion detection so that it is more appropriate for user-defined motion sensitivity control. When motion is detected in any video inputs, the TW6865 updates its motion status registers. Through which the host processor can read the motion information.

## **Audio Codec**

The audio codec in the TW6865 is composed of 8 audio Analog-to-Digital converters, audio mixer and audio detector. The TW6865 can accept 8 analog audio signals, and produce 8 channel digital audio data.

The level of analog audio input signal AIN1 ~ AIN8 can be adjusted respectively by internal programmable gain amplifiers that are defined via the AIGAIN1, AIGAIN2, AIGAIN3 and AIGAIN4 registers and then sampled by each Analog-to-Digital converters.

The TW6865 can mix all of analog audio inputs according to the predefined mixing ratio for each audio via the MIX\_RATIO1 ~ MIX\_RATIO4 registers. This mixing audio output can also be transferred through PCIe interface.

## **AUDIO DETECTION**

The TW6865 has an audio detector for individual 8 channels. There are 2 kinds of audio detection method defined by the AAMPMD. One is the detection of absolute amplitude and the other is of differential amplitude. For both detection methods, the accumulating period is defined by the ADET\_FILT register and the detecting threshold value is defined by the ADET\_TH1 ~ ADET\_TH4 registers.

## **DMA Controller**

This module mainly packs the received video and audio data to the defined maximum payload size and manages the target address of each transaction layer package. It uses round-robin arbitration among DMA channels to choose current on-duty one. The Legacy PCI INT\_A compatible interrupt emulation is supported to interrupt PC.

## **Internal Video & Audio Generator**

To assist video debugging, this generator outputs 8 different colorbar patterns for each video DMA channel. Each colorbar pattern includes 7 vertical color bars and 1 horizontal black/grey color whose position and width are adjustable.

To assist audio debugging, this generator outputs 8 different single tones with adjustable sampling rate. The 9<sup>th</sup> audio pattern is a mixing mode whose tone is chosen from one of others with register setting.

## **Control Unit**

This module handles configuration and control through PCIe to all internal blocks and registers such as DMA controller and PCIe EndPoint Controller.

## **GPIO & Ext. Controller**

This module controls all GPIO pins, configures external TW2864 through serial control pins (SCLK and SDAT), and resets external TW2864 through RST\_TO\_2864 pin.

## **PCI Express EndPoint Controller**

This controller contains three main PCI Express protocol layers: Transaction later, Data Link Layer, and Physical Layer. It complies with PCI Express Base Specification, Revision 1.1, and PCI Express 2.0 Base Specification, Revision 2.0. It works with external x1 PHY through the standard PHY Interface for PCI Express (PIPE).

## **PCI Express PHY**

This module is PCI express physical layer.

## **Host Interface**

The TW6865 provides with PCI Express interface for programming and controlling.

**REGISTER DESCRIPTION**

**DMA Controller**

Index		INT_STATUS								Default
		[7]	[6]	[5]	[4]	[3]	[2]	[1]	[0]	
0x00	B3	RSV	RSV	RSV	RSV	BAD_FMT_3	BAD_FMT_2	BAD_FMT_1	BAD_FMT_0	0x00
	B2	0	0	0	0	0	0	DMA_TOUT	0	0x00
	B1	INTSTA_DMA15	INTSTA_DMA14	INTSTA_DMA13	INTSTA_DMA12	INTSTA_DMA11	INTSTA_DMA10	INTSTA_DMA9	INTSTA_DMA8	0x00
	B0	RSV	RSV	RSV	RSV	INTSTA_DMA3	INTSTA_DMA2	INTSTA_DMA1	INTSTA_DMA0	0x00

- BAD\_FMT\_3**            B[27]    Bad incoming data format flag of video input -3  
 0 = no error detected  
 1 = wrong format detected from the incoming data  
 \* This bit status is controlled by DMA\_CONFIG[27:24]  
 \*\* BAD\_FMT = P\_BAD | P\_OV  
               See register VIDEO\_PARSER\_STATUS
- BAD\_FMT\_2**            B[26]    Bad incoming data format flag of video input -2
- BAD\_FMT\_1**            B[25]    Bad incoming data format flag of video input -1
- BAD\_FMT\_0**            B[24]    Bad incoming data format flag of video input -0
- 
- DMA\_TOUT**            B[17]    Time out flag of DMA channels
- 
- INTSTA\_DMA[15:8]**    B[15:8]    Interrupt request from DMA Channel-15 to Channel 8  
 0 = no interrupt  
 1 = interrupt
- 
- INTSTA\_DMA[3:0]**    B[3:0]    Interrupt request from DMA Channel-3 to Channel 0  
 0 = no interrupt  
 1 = interrupt

# TW6865

Index		PB_STATUS								Default
		[7]	[6]	[5]	[4]	[3]	[2]	[1]	[0]	
0x01	B3	RSV	RSV	RSV	RSV	FFLAG_DMA3	FFLAG_DMA2	FFLAG_DMA1	FFLAG_DMA0	0x00
	B2	0	0	0	0	0	0	0	0	0x00
	B1	PBFLAG_DMA15	PBFLAG_DMA14	PBFLAG_DMA13	PBFLAG_DMA12	PBFLAG_DMA11	PBFLAG_DMA10	PBFLAG_DMA9	PBFLAG_DMA8	0xFF
	B0	RSV	RSV	RSV	RSV	PBFLAG_DMA3	PBFLAG_DMA2	PBFLAG_DMA1	PBFLAG_DMA0	0xFF

- FFLAG\_DMA3**      B[27]      Field flag of DMA Channel-3  
0 = Field 1  
1 = Field 2  
\* It is valid only under block DMA mode. See PHASE\_REF
- FFLAG\_DMA2**      B[26]      Field flag of DMA Channel-2  
**FFLAG\_DMA1**      B[25]      Field flag of DMA Channel-1  
**FFLAG\_DMA0**      B[24]      Field flag of DMA Channel-0
- PBFLAG\_DMA15**    B[15]      PB flag of DMA Channel-15  
0 = P  
1 = B
- PBFLAG\_DMA14**    B[14]      PB flag of DMA Channel-14  
**PBFLAG\_DMA13**    B[13]      PB flag of DMA Channel-13  
**PBFLAG\_DMA12**    B[12]      PB flag of DMA Channel-12  
**PBFLAG\_DMA11**    B[11]      PB flag of DMA Channel-11  
**PBFLAG\_DMA10**    B[10]      PB flag of DMA Channel-10  
**PBFLAG\_DMA9**     B[9]        PB flag of DMA Channel-9  
**PBFLAG\_DMA8**     B[8]        PB flag of DMA Channel-8  
**PBFLAG\_DMA3**     B[3]        PB flag of DMA Channel-3  
**PBFLAG\_DMA2**     B[2]        PB flag of DMA Channel-2  
**PBFLAG\_DMA1**     B[1]        PB flag of DMA Channel-1  
**PBFLAG\_DMA0**     B[0]        PB flag of DMA Channel-0

# TW6865

Index		DMA_CMD								Default
		[7]	[6]	[5]	[4]	[3]	[2]	[1]	[0]	
0x02	B3	DMA_ENABLE	0	0	0	0	0	0	0	0x00
	B2	0	0	0	0	0	0	0	0	0x00
	B1	RESET_DMA15	RESET_DMA14	RESET_DMA13	RESET_DMA12	RESET_DMA11	RESET_DMA10	RESET_DMA9	RESET_DMA8	0xFF
	B0	RSV	RSV	RSV	RSV	RESET_DMA3	RESET_DMA2	RESET_DMA1	RESET_DMA0	0xFF

- DMA\_ENABLE      B[31]      General DMA enable bit  
0 = stop  
1 = start
- RESET\_DMA15      B[15]      Reset for DMA Channel-15  
0 = reset  
1 = normal
- RESET\_DMA14      B[14]      Reset for DMA Channel-14
- RESET\_DMA13      B[13]      Reset for DMA Channel-13
- RESET\_DMA12      B[12]      Reset for DMA Channel-12
- RESET\_DMA11      B[11]      Reset for DMA Channel-11
- RESET\_DMA10      B[10]      Reset for DMA Channel-10
- RESET\_DMA9        B[9]        Reset for DMA Channel-9
- RESET\_DMA8        B[8]        Reset for DMA Channel-8
- RESET\_DMA3        B[3]        Reset for DMA Channel-3
- RESET\_DMA2        B[2]        Reset for DMA Channel-2
- RESET\_DMA1        B[1]        Reset for DMA Channel-1
- RESET\_DMA0        B[0]        Reset for DMA Channel-0

# TW6865

Index		FIFO_STATUS								Default
		[7]	[6]	[5]	[4]	[3]	[2]	[1]	[0]	
0x03	B3	RSV	RSV	RSV	RSV	OV3	OV2	OV1	OV0	0x00
	B2	RSV	RSV	RSV	RSV	BAD_PTR_3	BAD_PTR_2	BAD_PTR_1	BAD_PTR_0	0x00
	B1	0	0	0	0	0	0	0	0	0x00
	B0	RSV	RSV	RSV	RSV	VDLOSS3	VDLOSS2	VDLOSS1	VDLOSS0	0x00

BAD_FMT_3	B[27]	DMA FIFO overflow flag of DMA channel-3 0 = no overflow 1 = overflow
BAD_FMT_2	B[26]	DMA FIFO overflow flag of DMA Channel -2
BAD_FMT_1	B[25]	DMA FIFO overflow flag of DMA Channel -1
BAD_FMT_0	B[24]	DMA FIFO overflow flag of DMA Channel -0
BAD_PTR_3	B[19]	DMA FIFO pointer error in DMA Channel-3 0 = no error 1 = has error
BAD_PTR_2	B[18]	DMA FIFO pointer error in DMA Channel-2
BAD_PTR_1	B[17]	DMA FIFO pointer error in DMA Channel-1
BAD_PTR_0	B[16]	DMA FIFO pointer error in DMA Channel-0
VDLOSS_3	B[3]	Video signal lost for Channel-3 0 = no error 1 = has error
VDLOSS_2	B[2]	Video signal lost for Channel-2
VDLOSS_1	B[1]	Video signal lost for Channel-1
VDLOSS_0	B[0]	Video signal lost for Channel-0

# TW6865

Index		VIDEO_CHANNEL_ID								Default
		[7]	[6]	[5]	[4]	[3]	[2]	[1]	[0]	
0x04	B3	0	0	0	0	0	0	0	0	0x00
	B2	7			6			5		0x92
	B1	4			3					0x46
	B0	2		1			0			0x88



## TW6865

Index		VIDEO_PARSER_STATUS								Default
		[7]	[6]	[5]	[4]	[3]	[2]	[1]	[0]	
0x05	B3	0	0	0	0	0	0	0	0	0x00
	B2	0	0	0	0	0	0	0	0	0x00
	B1	RSV	RSV	RSV	RSV	P_OV3	P_OV2	P_OV1	P_OV0	0x00
	B0	RSV	RSV	RSV	RSV	P_BAD3	P_BAD2	P_BAD1	P_BAD0	0x00

**P\_OV3**                    **B[11]**      Parser FIFO overflow flag for video input-3  
**P\_OV2**                    **B[10]**      Parser FIFO overflow flag for video input-2  
**P\_OV1**                    **B[9]**        Parser FIFO overflow flag for video input-1  
**P\_OV0**                    **B[8]**        Parser FIFO overflow flag for video input-0  
 \* These status bits are kept asserted until been read

**P\_BAD 3**                 **B[3]**        Parser found bad format at incoming video input-3  
**P\_BAD 2**                 **B[2]**        Parser found bad format at incoming video input-2  
**P\_BAD 1**                 **B[1]**        Parser found bad format at incoming video input-1  
**P\_BAD 0**                 **B[0]**        Parser found bad format at incoming video input-0  
 \* The status bits are kept asserted until been read

## TW6865

Index		SYS_SOFT_RST								Default
		[7]	[6]	[5]	[4]	[3]	[2]	[1]	[0]	
0x06	B3	0	0	0	0	0	0	0	0	0x00
	B2	0	0	0	0	0	0	0	0	0x00
	B1	0	0	0	0	0	0	0	0	0x00
	B0	0	0	0	0	RESET_AV_REG	RESET_DMA_CTRL	RESET_DEC_INTF	RESET_EXT_PHY	0x07

RESET\_AV\_REG            B[3]     Reset for registers of internal AV decoder.  
 RESET\_DMA\_CTRL        B[2]     Reset for DMA controller.  
 RESET\_DEC\_INTF        B[1]     Reset for decode interface.  
 RESET\_EXT\_PHY         B[0]     Reset for external PHY. It is a software reset, active low and self clear.

# TW6865

Index		DMA_PAGE_TABLE_ADDR								Default
		[7]	[6]	[5]	[4]	[3]	[2]	[1]	[0]	
0x08	B3	PAGE_TABLE0_ADDR (Channel 0)								0x00
	B2									0x00
	B1									0x00
	B0									0x00
0x09	B3	PAGE_TABLE1_ADDR (Channel 0)								0x00
	B2									0x00
	B1									0x00
	B0									0x00
0xD0	B3	PAGE_TABLE0_ADDR (Channel 1)								0x00
	B2									0x00
	B1									0x00
	B0									0x00
0xD1	B3	PAGE_TABLE1_ADDR (Channel 1)								0x00
	B2									0x00
	B1									0x00
	B0									0x00
0xD2	B3	PAGE_TABLE0_ADDR (Channel 2)								0x00
	B2									0x00
	B1									0x00
	B0									0x00
0xD3	B3	PAGE_TABLE1_ADDR (Channel 2)								0x00
	B2									0x00
	B1									0x00
	B0									0x00
0xD4	B3	PAGE_TABLE0_ADDR (Channel 3)								0x00
	B2									0x00
	B1									0x00
	B0									0x00
0xD5	B3	PAGE_TABLE1_ADDR (Channel 3)								0x00
	B2									0x00
	B1									0x00
	B0									0x00
	B2									0x00
	B1									0x00
	B1									0x00
	B0									0x00

PAGE\_TABLE0\_ADDR B[31:0] The address of page0 table

PAGE\_TABLE1\_ADDR B[31:0] The address of page1 table

Driver needs to allocate 2 pages of Non-Pageable memory, and saves allocated addresses to these 2 registers for each video DMA channel

Each page is 4096-bytes continuously buffer.

Every 8-bytes (2 DWord) is called one Descriptor. Each page has 4096/8=512 video descriptors.

The following is the video descriptor's data structure (little endian format)

B[63:32] = target address of DMA

B[31:30] = descriptor status

## TW6865

---

- 0 = Host buffer unavailable
- 1 = Host buffer available
- 2 = This buffer has been filled by DMA successfully
- 3 = This buffer has been filled by DMA with error

B[29] = new frame flag  
B[28:21] = do not care  
B[20:14] = do not care  
B[13] = do not care  
B[12:0] = total byte length requirement

# TW6865

Index		DMA_CHANNEL_ENABLE								Default
		[7]	[6]	[5]	[4]	[3]	[2]	[1]	[0]	
0x0A	B3	0	0	0	0	0	0	0	0	0x00
	B2	0	0	0	0	0	0	0	0	0x00
	B1	ENA_DMA15	ENA_DMA14	ENA_DMA13	ENA_DMA12	ENA_DMA11	ENA_DMA10	ENA_DMA9	ENA_DMA8	0x00
	B0	RSV	RSV	RSV	RSV	ENA_DMA3	ENA_DMA2	ENA_DMA1	ENA_DMA0	0x00

ENA_DMA15	B[15]	Enable DMA Channel-15
ENA_DMA14	B[14]	Enable DMA Channel-14
ENA_DMA13	B[13]	Enable DMA Channel-13
ENA_DMA12	B[12]	Enable DMA Channel-12
ENA_DMA11	B[11]	Enable DMA Channel-11
ENA_DMA10	B[10]	Enable DMA Channel-10
ENA_DMA9	B[9]	Enable DMA Channel-9
ENA_DMA8	B[8]	Enable DMA Channel-8
ENA_DMA3	B[3]	Enable DMA Channel-3
ENA_DMA2	B[2]	Enable DMA Channel-2
ENA_DMA1	B[1]	Enable DMA Channel-1
ENA_DMA0	B[0]	Enable DMA Channel-0

# TW6865

Index		DMA_CONFIG								Default
		[7]	[6]	[5]	[4]	[3]	[2]	[1]	[0]	
0B	B3	RSV	RSV	RSV	RSV	MASK_BAD_FMT3	MASK_BAD_FMT2	MASK_BAD_FMT1	MASK_BAD_FMT0	0x00
	B2	RSV	RSV	RSV	RSV	MASK_BAD_PTR3	MASK_BAD_PTR2	MASK_BAD_PTR1	MASK_BAD_PTR0	0x00
	B1	RSV	RSV	RSV	RSV	MASK_OV_3	MASK_OV_2	MASK_OV_1	MASK_OV_0	0x00
	B0	0	0	0	0	ENA_CPL_WAIT	ENA_INTX	0	BIG_ENDIAN	0x04

**MASK\_BAD\_FMT**      B[27:24]    Mask bad format error of incoming data of DMA Channel  
 0 = mask off, no report  
 1 = ON

**MASK\_BAD\_PTR**      B[19:16]    Enable DMA FIFO pointer check of DMA Channel  
 0 = mask off, no report  
 1 = ON

**MASK\_OVF**          B[11:8]     Enable DMA FIFO overflow check of DMA Channel  
 0 = mask off, no report  
 1 = ON

**ENA\_CPL\_WAIT**      B[3]        Wait for CPL done during initialization stage  
 0 = disable  
 1 = enable

**ENA\_INTX**          B[2]        INTx enable, should be set to 1 by driver  
**BIG\_ENDIAN**        B[0]        Big endian enable  
 0 = little endian  
 1 = big endian

# TW6865

Index		DMA_TIMER_INTERVAL								Default
		[7]	[6]	[5]	[4]	[3]	[2]	[1]	[0]	
0x0C	B3	0	0	0	0	0	0	0	0	0x00
	B2	0	0	DMA_INT_TIMER[21:16]						0x09
	B1	DMA_INT_TIMER[15:0]								0x89
	B0	DMA_INT_TIMER[15:0]								0x68

DMA\_INT\_TIMER      B[21:0]    Minimum time span for DMA interrupting host.

## TW6865

Index		DMA_CHANNEL_TIMEOUT							Default
		[7]	[6]	[5]	[4]	[3]	[2]	[1]	
0x0D	B3	0	0	PRE_TIMEOUT_OFST					0x14
	B2	DMA_DAT_CH_TIMEOUT[11:4]							0x0C
	B1	DMA_DAT_CH_TIMEOUT[3:0]			DMA_VDO_CH_TIMEOUT[11:8]				0x85
	B0	DMA_VDO_CH_TIMEOUT[7:0]							0x84

**PRE\_TIMEOUT\_OFST**    B[29:24]    Offset from pre timeout to final timeout  
**DMA\_DAT\_CH\_TIMEOUT**    B[23:12]    Service timeout of each DMA data channel  
**DMA\_VDO\_CH\_TIMEOUT**    B[11:0]    Service timeout of each DMA video channel  
 Note: It should be set a big value to avoid time out.



# TW6865

Index		DMA_CHANNEL_CONFIG							Default	
		[7]	[6]	[5]	[4]	[3]	[2]	[1]		[0]
0x10	B3	VIN_MUX_SELO	FIELD_OUT0	ENA_FIELD_DR OPO	ENA_MASTER0	MASTER_CHID0	ENA_VDECIO	0x00		
	B2	ENA_HDECIO	VIDEO_OUT_FORMAT0		END_IDX_DMA0[9:6]				0x00	
	B1	END_IDX_DMA0[5:0]				START_IDX_DMA0[9:8]				0x00
	B0	START_IDX_DMA0[7:0]							0x00	
0x11	B3	VIN_MUX_SEL1	FIELD_OUT1	ENA_FIELD_DR OP1	ENA_MASTER1	MASTER_CHID1	ENA_VDEC11	0x00		
	B2	ENA_HDEC11	VIDEO_OUT_FORMAT1		END_IDX_DMA1[9:6]				0x00	
	B1	END_IDX_DMA1[5:0]				START_IDX_DMA1[9:8]				0x00
	B0	START_IDX_DMA1[7:0]							0x00	
0x12	B3	VIN_MUX_SEL2	FIELD_OUT2	ENA_FIELD_DR OP2	ENA_MASTER2	MASTER_CHID2	ENA_VDEC12	0x00		
	B2	ENA_HDEC12	VIDEO_OUT_FORMAT2		END_IDX_DMA2[9:6]				0x00	
	B1	END_IDX_DMA2[5:0]				START_IDX_DMA2[9:8]				0x00
	B0	START_IDX_DMA2[7:0]							0x00	
0x13	B3	VIN_MUX_SEL3	FIELD_OUT3	ENA_FIELD_DR OP3	ENA_MASTER3	MASTER_CHID3	ENA_VDEC13	0x00		
	B2	ENA_HDEC13	VIDEO_OUT_FORMAT3		END_IDX_DMA3[9:6]				0x00	
	B1	END_IDX_DMA3[5:0]				START_IDX_DMA3[9:8]				0x00
	B0	START_IDX_DMA3[7:0]							0x00	

# TW6865

VIN_MUX_SEL	B[31:30]	Analog Mux input selection for build-in video decoder 1~4 respectively 0 = Select input 0 1 = Select input 1 2 = Select input 2 3 = Select input 3
FIELD_OUT	B[29]	Which field dropped (applicable for master only) 0 = Field1 dropped 1 = Field2 dropped
ENA_FIELD_DROP	B[28]	Drop off field 0 = no drop 1 = drop
ENA_MASTER	B[27]	Master or slave 0 = slave 1 = master
MASTER_CHID	B[26:25]	Master channel # of the current one. For master channel, it is itself
ENA_VDECI	B[24]	Vertical (line) decimation 0 = No decimation 1 = 2:1 Decimation
ENA_HDECI	B[23]	Horizontal (pixel) decimation 0 = No decimation 1 = 2:1 Decimation
VIDEO_OUT_FORMAT	B[22:20]	Set output video format 000b = UYVY / Y422 001b = Y420 010b = IYU1 / Y411 011b = Y41P 100b = RGB 555 101b = RGB 565 110b = YUYV / YUY2 111b = Reserved

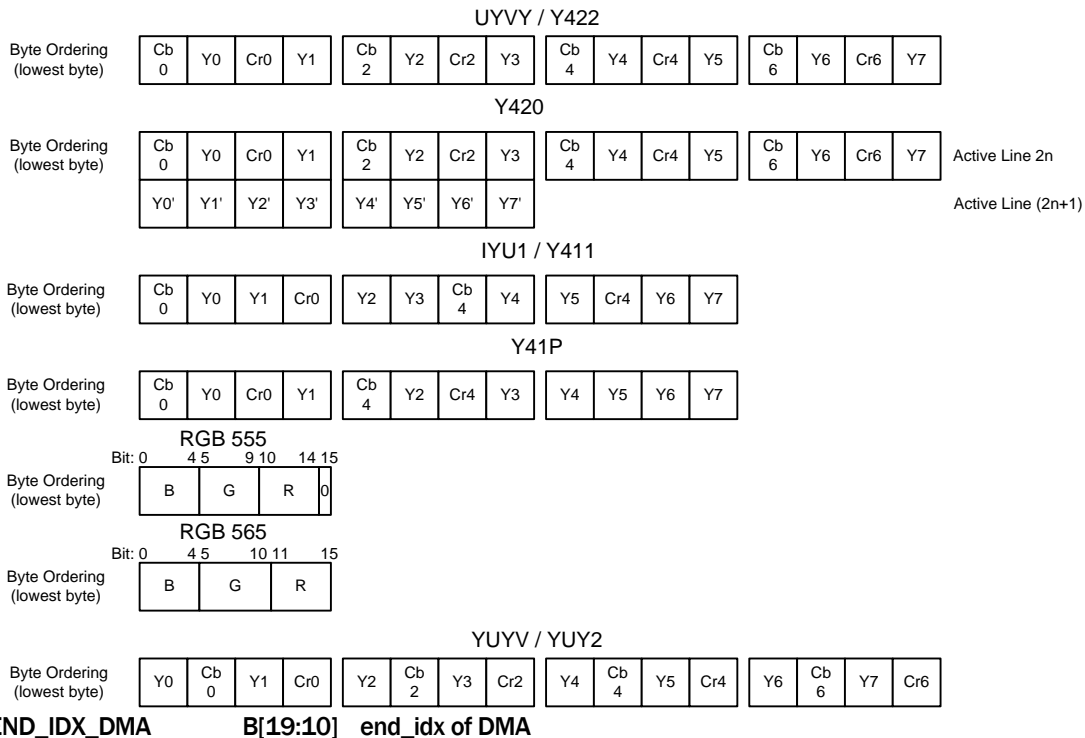

## TW6865

---

START\_IDX\_DMA      B[ 9: 0]    start\_idx of DMA

NOTE: B[29:25] are used for field dropping purpose.

(1) DMA0-3 and DMA4-7 are 2 big groups.

(2) Master means this DMA channel has higher priority to drop preferred field (odd/even), and slave means this channel is affected by master. Whenever master channel is sending data, it must drop the received.

# TW6865

Index	DMA_PB_CONFIG								Default
	[7]	[6]	[5]	[4]	[3]	[2]	[1]	[0]	
0x18	DMA8_P_ADDR								0x0000_0000
0x19	DMA8_B_ADDR								0x0000_0000
0x1A	DMA9_P_ADDR								0x0000_0000
0x1B	DMA9_B_ADDR								0x0000_0000
0x1C	DMAA_P_ADDR								0x0000_0000
0x1D	DMAA_B_ADDR								0x0000_0000
0x1E	DMAB_P_ADDR								0x0000_0000
0x1F	DMAB_B_ADDR								0x0000_0000
0x20	DMAC_P_ADDR								0x0000_0000
0x21	DMAC_B_ADDR								0x0000_0000
0x22	DMAD_P_ADDR								0x0000_0000
0x23	DMAD_B_ADDR								0x0000_0000
0x24	DMAE_P_ADDR								0x0000_0000
0x25	DMAE_B_ADDR								0x0000_0000
0x26	DMAF_P_ADDR								0x0000_0000
0x27	DMAF_B_ADDR								0x0000_0000

**DMA\_P/B\_ADDR**      [31:0]      Starting addresses for DMA Channel-8 ~ Channel-16.  
 Each Channel has 2 starting addresses for P-buffer and B-buffer respectively.  
 These buffer addresses are allocated by Driver during initialization. They are called as Common Buffer. Driver needs to copy data from these buffers to their destination

## TW6865

Index		VIDEO_CONTROL1								Default
		[7]	[6]	[5]	[4]	[3]	[2]	[1]	[0]	
0x2A	B3	0	0	0	0	0	0	0	0	0x00
	B2	0	0	0	0	0	0	0	SYS_MODE_DMA3	0x00
	B1	SYS_MODE_DMA2	SYS_MODE_DMA1	SYS_MODE_DMA0	0	0	VSCL_ENA_1	0	0	0x00
	B0	HACL_ENA_0	VSCL_ENA_0	0	0	0	0	0	0	0x01

**SYS\_MODE\_DMA3**    B[16]    System mode for DMA Channel-3  
 0 = 525 Lines  
 1 = 625 Lines

**SYS\_MODE\_DMA2**    B[15]    System mode for DMA Channel-2

**SYS\_MODE\_DMA1**    B[14]    System mode for DMA Channel-1

**SYS\_MODE\_DMA0**    B[13]    System mode for DMA Channel-0

B[10] set the input format of DMA Channel-4~Channel-7.

**VSCL\_ENA\_1**        B[10]    Vertical scaler  
 0 = Disabled  
 1 = Enabled (360x240)

B[7:6] set the input format of DMA Channel-0~Channel-3.

**HACL\_ENA\_0**        B[7]     Horizontal scaler  
 0 = Disabled (full D1)  
 1 = Enabled - 360x480(B[6]=0) or 360x240(B[6]=1)

**VSCL\_ENA\_0**        B[6]     Vertical scaler  
 0 = Disabled  
 1 = Enabled (360x240) – B[7] must be “1”

# TW6865

Index		VIDEO_CONTROL2								Default
		[7]	[6]	[5]	[4]	[3]	[2]	[1]	[0]	
0x2B	B3	0	0	0	0	0	0	0	0	0x00
	B2	0	0	0	0	RST_GEN3	RST_GEN2	RST_GEN1	RST_GEN0	0xFF
	B1	0	0	0	0	PAT_SEL_GEN3	PAT_SEL_GEN2	PAT_SEL_GEN1	PAT_SEL_GEN0	0x00
	B0	0	0	0	0	EXT_VDAT_ENA3	EXT_VDAT_ENA2	EXT_VDAT_ENA1	EXT_VDAT_ENA0	0xFF

RST_GEN3	B[19]	Reset control for YUV Generator-3 0 = reset 1 = not reset
RST_GEN2	B[18]	Reset control for YUV Generator-2
RST_GEN1	B[17]	Reset control for YUV Generator-1
RST_GEN0	B[16]	Reset control for YUV Generator-0
PAT_SEL_GEN3	B[11]	Pattern selector for YUV Generator-7 0 = Color Bar 1 = Sequenced Data
PAT_SEL_GEN2	B[10]	Pattern selector for YUV Generator-2
PAT_SEL_GEN1	B[9]	Pattern selector for YUV Generator-1
PAT_SEL_GEN0	B[8]	Pattern selector for YUV Generator-0
EXT_VDAT_ENA3	B[3]	selection for each video DMA Channel-7 0 = Use build in YUV Generator 1 = Use external inputs
EXT_VDAT_ENA2	B[2]	selection for each video DMA Channel-2
EXT_VDAT_ENA1	B[1]	selection for each video DMA Channel-1
EXT_VDAT_ENA0	B[0]	selection for each video DMA Channel-0

# TW6865

Index		AUDIO_CONTROL1							Default
		[7]	[6]	[5]	[4]	[3]	[2]	[1]	
0x2C	B3	BYTE_LENGTH_DMA8TO16[12:5]							0x80
	B2	BYTE_LENGTH_DMA8TO16[4:0]				INT_GEN_ADAT_RATE[13:11]			0x07
	B1	INT_GEN_ADAT_RATE[10:3]							0xA1
	B0	INT_GEN_ADAT_RATE[2:0]		PAT_SEL_ADO	MIX_MODE			EXT_ADAT_ENA	0x21

- BYTE\_LENGTH\_DMA8TO16**      B[31:19] Total byte length requirement of Audio DMA Channel-8 ~ Channel-16 (default: 4096 bytes)
- INT\_GEN\_ADAT\_RATE**      B[18:5] Internal audio generator sampling rate  
For example, if sampling rate is 8k, the value should be  $125M/8K = 15625 = 0x3d09$  (default)
- PAT\_SEL\_ADO**      B[4] Pattern selector for internal audio signal generator  
0 = Sine wave  
1 = Sequenced Data
- MIX\_MODE**      B[3:1] Mix mode of internal mixed audio generator  
111b = output audio channel-7 data  
....  
000b = output audio channel-0 data
- EXT\_ADAT\_ENA**      B[0] 0 = Use build-in sine waveform generator for Ch8-ChB  
1 = Use external inputs

# TW6865

Index		AUDIO_CONTROL2							Default
		[7]	[6]	[5]	[4]	[3]	[2]	[1]	
0x2D	B3	0	0	AUDIO_CLK_REF[29:24]					0x3D
	B2								0x09
	B1	AUDIO_CLK_REF[23:0]							0x00
	B0								0x00

**AUDIO\_CLK\_REF**      B[29:0]      Audio sampling frequency reference  
 $A_{ref} = (2^{24}) * 125\text{MHz} / (256 * F_s)$

Sampling Rate (kHz)	Value (HEX)
8	0x3D09_0000
16	0x1E84_8000
32	0x0F42_4000
44.1	0x0B12_7795
48	0x0A2C_2AAA



# TW6865

Index		PHASE_REF						Default		
		[7]	[6]	[5]	[4]	[3]	[2]		[1]	[0]
0x2E	B3	0		0		0		0		0x00
	B2	DMA_MODE3		DMA_MODE2		DMA_MODE1		DMA_MODE0		0x00
	B1	0	0	PHASE_REF[13:8]						0x14
	B0	PHASE_REF[7:0]								0x4D

- DMA\_MODE3**      B[23:22] DMA mode configuration of DMA Channel-3  
00b = S & G mode  
01b = Reserved  
10b = Frame mode  
11b = Field mode
- DMA\_MODE2**      B[21:20] DMA mode configuration of DMA Channel-2
- DMA\_MODE1**      B[19:18] DMA mode configuration of DMA Channel-1
- DMA\_MODE0**      B[17:16] DMA mode configuration of DMA Channel-0
- PHASE\_REF**      B[13:0] Phase reference for rate conversion at each Video DMA channel. Valid range is [4800:5400].

# TW6865

Index		GPIO_REG								Default
		[7]	[6]	[5]	[4]	[3]	[2]	[1]	[0]	
0x2F	B3	GPP_C15	GPP_C14	GPP_C13	GPP_C12	GPP_C11	GPP_C10	GPP_C9	GPP_C8	0xFF
	B2	GPP_C7	GPP_C6	GPP_C5	GPP_C4	GPP_C3	GPP_C2	SDA_C1	GPP_C0	0xFF
	B1	GPP_D15	GPP_D14	GPP_D13	GPP_D12	GPP_D11	GPP_D10	GPP_D9	GPP_D8	0x00
	B0	GPP_D7	GPP_D6	GPP_D5	GPP_D4	GPP_D3	GPP_D2	DPP_D1	GPP_D0	0x00
0xE0	B3	GPP_C31	GPP_C30	GPP_C29	GPP_DC8	GPP_C27	GPP_C26	GPP_C25	GPP_C24	0xFF
	B2	GPP_C23	GPP_C22	GPP_C21	GPP_DC0	GPP_C19	GPP_C18	DPP_C17	GPP_C16	0xFF
	B1	GPP_D31	GPP_D30	GPP_D29	GPP_D28	GPP_D27	GPP_D26	GPP_D25	GPP_D24	0x00
	B0	GPP_D23	GPP_D22	GPP_D21	GPP_D20	GPP_D19	GPP_D18	DPP_D17	GPP_D16	0x00
0xE1	B3	GPP_C47	GPP_C46	GPP_C45	GPP_C44	GPP_C43	GPP_C42	GPP_C41	GPP_C40	0xFF
	B2	GPP_C39	GPP_C38	GPP_C37	GPP_C36	GPP_C35	GPP_C34	DPP_C33	GPP_C32	0xFF
	B1	GPP_D47	GPP_D46	GPP_D45	GPP_D44	GPP_D43	GPP_D42	GPP_D41	GPP_D40	0x00
	B0	GPP_D39	GPP_D38	GPP_D37	GPP_D36	GPP_D35	GPP_D34	DPP_D33	GPP_D32	0x00

GPP\_Cn                                  I/O control of GPIO pin  
 0 = Pin is output  
 1 = Pin is input

.....  
 GPP\_Dn                                  GPIO pin

# TW6865

Index		INTL_HBAR_CTRL								Default
		[7]	[6]	[5]	[4]	[3]	[2]	[1]	[0]	
0x30	B3	0	0	0	0	0	0	0	0	0x00
	B2	0	0	0	0	0	0	0	0	0x00
	B1	HEIGHT_HBAR0								0x0A
	B0	ST_LINE_HBAR0								0x0A
0x31	B3	0	0	0	0	0	0	0	0	0x00
	B2	0	0	0	0	0	0	0	0	0x00
	B1	HEIGHT_HBAR1								0x0A
	B0	ST_LINE_HBAR1								0x14
0x32	B3	0	0	0	0	0	0	0	0	0x00
	B2	0	0	0	0	0	0	0	0	0x00
	B1	HEIGHT_HBAR2								0x0A
	B0	ST_LINE_HBAR2								0x1E
0x33	B3	0	0	0	0	0	0	0	0	0x00
	B2	0	0	0	0	0	0	0	0	0x00
	B1	HEIGHT_HBAR3								0x0A
	B0	ST_LINE_HBAR3								0x28

HEIGHT\_HBAR      B[15:8]    Height (lines) of horizontal bar.  
 ST\_LINE\_HBAR    B[ 7:0]    Start line (position) of horizontal bar, ranges at [10 = 255]

# TW6865

Index		AUDIO_CONTROL3								Default
		[7]	[6]	[5]	[4]	[3]	[2]	[1]	[0]	
0x38	B3	0	0	0	0	0	0	0	0	0x00
	B2	0	0	0	0	0	0	0	0	0x00
	B1	0	0	0	0	0	0	0	OUT_BITWIDTH	0x00
	B0	0	0	0	0	0	0	0	0	0x40

**OUT\_BITWIDTH**      B[8]      Audio DMA output bit width  
    0 = 16 bits  
    1 = 8 bits

# TW6865

Index		VIDEO_FIELD_CTRL							Default
		[7]	[6]	[5]	[4]	[3]	[2]	[1]	
0x39	B3	FLD_CTRL_ENA 0	START_ FLD0	FLD_OUT_OPT0[29:24]					0x00
	B2								0x00
	B1	FLD_OUT_OPT0[23:0]							0x00
	B0								0x00
0x3A	B3	FLD_CTRL_ENA 1	START_ FLD1	FLD_OUT_OPT1[29:24]					0x00
	B2								0x00
	B1	FLD_OUT_OPT1[23:0]							0x00
	B0								0x00
0x3B	B3	FLD_CTRL_ENA 2	START_ FLD2	FLD_OUT_OPT2[29:24]					0x00
	B2								0x00
	B1	FLD_OUT_OPT2[23:0]							0x00
	B0								0x00
0x3C	B3	FLD_CTRL_ENA 3	START_ FLD3	FLD_OUT_OPT3[29:24]					0x00
	B2								0x00
	B1	FLD_OUT_OPT3[23:0]							0x00
	B0								0x00

**FLD\_CTRL\_ENA**      B[31]      Enable bit for each field control register  
0 = output both odd and even field  
1 = output according to B20~B0

**START\_FLD**      B[30]      Starting field control bit  
0 = starting from field 2  
1 = starting from field 1

**FLD\_OUT\_OPT**      B[29:0]      Output flag of consecutive 30(NTSC)/25(PAL) fields.  
0 = not output  
1 = output

# TW6865

Index		HSCALER_CTRL							Default
		[7]	[6]	[5]	[4]	[3]	[2]	[1]	
0x42	B3	HSCALER_ENA0	PHASE_REF0[15:9]						0x7C
	B2	PHASE_REF0[8:1]							0x71
	B1	PHASE_REF0[0]	END_POS0[9:3]						0xD8
	B0	END_POS0[2:0]			START_POS0				0xCA
0x43	B3	HSCALER_ENA1	PHASE_REF1[15:9]						0x7C
	B2	PHASE_REF1[8:1]							0x71
	B1	PHASE_REF1[0]	END_POS1[9:3]						0xD8
	B0	END_POS1[2:0]			START_POS1				0xCA
0x44	B3	HSCALER_ENA2	PHASE_REF2[15:9]						0x7C
	B2	PHASE_REF2[8:1]							0x71
	B1	PHASE_REF2[0]	END_POS2[9:3]						0xD8
	B0	END_POS2[2:0]			START_POS2				0xCA
0x45	B3	HSCALER_ENA3	PHASE_REF3[15:9]						0x7C
	B2	PHASE_REF3[8:1]							0x71
	B1	PHASE_REF3[0]	END_POS3[9:3]						0xD8
	B0	END_POS3[2:0]			START_POS3				0xCA

**HSCALER\_ENA**      B[31]      Customize horizontal scaler enable bit  
 0 = disable  
 1 = enable

**PHASE\_REF**      B[30:15]      Scaler phase reference. Its calculation is  
 $Phase\_ref = (END\_POS - START\_POS) * (2^{16}) / Total\_Active\_Pixel\_Per\_Line$   
 For example,  
 START\_POS = 10, END\_POS = 710,  
 Total\_Active\_Pixel\_Per\_Line = 720,  
 $Phase\_ref = (710 - 10) * 2^{16} / 720 = 0xF8E3$

**END\_POS**      B[14:5]      End pixel position of each line. This pixel will NOT  
 be shown and the setting must be an even number.  
**START\_POS**      B[4:0]      Start pixel position of each line. This pixel will be  
 shown and the setting must be an even number.

# TW6865

Index		VIDEO_SIZE								Default
		[7]	[6]	[5]	[4]	[3]	[2]	[1]	[0]	
0x4A	B3	VS_EN0	VS_F2_EN0	0	0	0	0	0	V_SIZE0[8]	0x00
	B2	V_SIZE0[7:0]								0xF0
	B1	0	0	0	0	0	H_SIZE0[10:8]			0x02
	B0	H_SIZE0[7:0]								0xD0
0x4B	B3	VS_EN1	VS_F2_EN1	0	0	0	0	0	V_SIZE1[8]	0x00
	B2	V_SIZE1[7:0]								0xF0
	B1	0	0	0	0	0	H_SIZE1[10:8]			0x02
	B0	H_SIZE1[7:0]								0xD0
0x4C	B3	VS_EN2	VS_F2_EN2	0	0	0	0	0	V_SIZE2[8]	0x00
	B2	V_SIZE2[7:0]								0xF0
	B1	0	0	0	0	0	H_SIZE2[10:8]			0x02
	B0	H_SIZE2[7:0]								0xD0
0x4D	B3	VS_EN3	VS_F2_EN3	0	0	0	0	0	V_SIZE3[8]	0x00
	B2	V_SIZE3[7:0]								0xF0
	B1	0	0	0	0	0	H_SIZE3[10:8]			0x02
	B0	H_SIZE3[7:0]								0xD0

VS\_EN                      B[31]                      Customize video size enable bit  
0 = disable  
1 = enable

VS\_F2\_EN                  B[30]                      Enable to field 2 video size control registers  
0 = Field 2 video size controlled by VIDEO\_SIZE<sub>x</sub>  
1 = Field 2 video size controlled by VIDEO\_SIZE<sub>x</sub>\_F2  
Note: "x" means DMA channel number (0~7)

V\_SIZE                      B[24:16]                      Height of field.  
H\_SIZE                      B[10:0]                      Width of field

# TW6865

Index		VIDEO_SIZE_F2								Default
		[7]	[6]	[5]	[4]	[3]	[2]	[1]	[0]	
0x52	B3	0	0	0	0	0	0	0	V_SIZE0_F2[8]	0x00
	B2	V_SIZE0_F2[7:0]								0xF0
	B1	0	0	0	0	0	H_SIZE0_F2[10:8]			0x02
	B0	H_SIZE0_F2[7:0]								0xD0
0x53	B3	0	0	0	0	0	0	0	V_SIZE1_F2[8]	0x00
	B2	V_SIZE1_F2[7:0]								0xF0
	B1	0	0	0	0	0	H_SIZE1_F2[10:8]			0x02
	B0	H_SIZE1_F2[7:0]								0xD0
0x54	B3	0	0	0	0	0	0	0	V_SIZE2_F2[8]	0x00
	B2	V_SIZE2_F2[7:0]								0xF0
	B1	0	0	0	0	0	H_SIZE2_F2[10:8]			0x02
	B0	H_SIZE2_F2[7:0]								0xD0
0x55	B3	0	0	0	0	0	0	0	V_SIZE3_F2[8]	0x00
	B2	V_SIZE3_F2[7:0]								0xF0
	B1	0	0	0	0	0	H_SIZE3_F2[10:8]			0x02
	B0	H_SIZE3_F2[7:0]								0xD0

V\_SIZE\_F2  
H\_SIZE\_F2

B[24:16]  
B[10:0]

Height of field 2.  
Width of field 2.



# TW6865

Index	MD_CONF									Default	
	[7]	[6]	[5]	[4]	[3]	[2]	[1]	[0]			
0x60	B3	0	0	0	0	0	0	0	0	0x00	
	B2	MD0_TSCALE			MD0_ENABLE	MD0_ACT_FLD	MD0_MODE	MD0_THRESHOLD[17:16]			0x05
	B1	MD0_THRESHOLD[15:8]									0x04
	B0	MD0_THRESHOLD[7:0]									0x10
0x61	B3	0	0	0	0	0	0	0	0	0x00	
	B2	MD1_TSCALE			MD1_ENABLE	MD1_ACT_FLD	MD1_MODE	MD1_THRESHOLD[17:16]			0x05
	B1	MD1_THRESHOLD[15:8]									0x04
	B0	MD1_THRESHOLD[7:0]									0x10
0x62	B3	0	0	0	0	0	0	0	0	0x00	
	B2	MD2_TSCALE			MD2_ENABLE	MD2_ACT_FLD	MD2_MODE	MD2_THRESHOLD[17:16]			0x05
	B1	MD2_THRESHOLD[15:8]									0x04
	B0	MD2_THRESHOLD[7:0]									0x10
0x63	B3	0	0	0	0	0	0	0	0	0x00	
	B2	MD3_TSCALE			MD3_ENABLE	MD3_ACT_FLD	MD3_MODE	MD3_THRESHOLD[17:16]			0x05
	B1	MD3_THRESHOLD[15:8]									0x04
	B0	MD3_THRESHOLD[7:0]									0x10

MD_TSCALE	B[23:21]	Scale amount of threshold (T<<TSCALE)
MD_ENABLE	B[20]	Enable Motion Detection 0: disable 1: enable
MD_ACT_FLD	B [19]	Motion Detection Active Field 0: Field 0 1: Field 1
MD_MODE	B [18]	Motion Detection Block Size 0: Block size is 16x16 1: Block size is 32x32
MD_TRESHOLD	B[17:0]	Threshold for Motion or Static

# TW6865

Index		MD_INIT								Default
		[7]	[6]	[5]	[4]	[3]	[2]	[1]	[0]	
0x68	B3	0	0	0	0	0	0	0	0	0x00
	B2	0	0	0	0	0	0	0	0	0x00
	B1	0	0	0	0	0	0	0	0	0x00
	B0	0	0	0	0	0	0	0	MD0_INIT	0x00
0x69	B3	0	0	0	0	0	0	0	0	0x00
	B2	0	0	0	0	0	0	0	0	0x00
	B1	0	0	0	0	0	0	0	0	0x00
	B0	0	0	0	0	0	0	0	MD1_INIT	0x00
0x6A	B3	0	0	0	0	0	0	0	0	0x00
	B2	0	0	0	0	0	0	0	0	0x00
	B1	0	0	0	0	0	0	0	0	0x00
	B0	0	0	0	0	0	0	0	MD2_INIT	0x00
0x6B	B3	0	0	0	0	0	0	0	0	0x00
	B2	0	0	0	0	0	0	0	0	0x00
	B1	0	0	0	0	0	0	0	0	0x00
	B0	0	0	0	0	0	0	0	MD3_INIT	0x00

MD\_INIT

B[0]

Motion Detection Read Pointer Initialization. By Writing any value to it, the read pointer will be reset.

# TW6865

Index		MD_MAPO								Default
		[7]	[6]	[5]	[4]	[3]	[2]	[1]	[0]	
0x70	B3	0	0	0	0	0	0	0	0	0x00
	B2	MD0_MAPO[23:16]								0x00
	B1	MD0_MAPO[15:8]								0x00
	B0	MD0_MAPO[7:0]								0x00
0x71	B3	0	0	0	0	0	0	0	0	0x00
	B2	MD1_MAPO[23:16]								0x00
	B1	MD1_MAPO[15:8]								0x00
	B0	MD1_MAPO[7:0]								0x00
0x72	B3	0	0	0	0	0	0	0	0	0x00
	B2	MD2_MAPO[23:16]								0x00
	B1	MD2_MAPO[15:8]								0x00
	B0	MD2_MAPO[7:0]								0x00
0x73	B3	0	0	0	0	0	0	0	0	0x00
	B2	MD3_MAPO[23:16]								0x00
	B1	MD3_MAPO[15:8]								0x00
	B0	MD3_MAPO[7:0]								0x00

**MD\_MAPO B[23:0]** Map of motion detection output for blocks of current slice.

Note: Video Frame is partitioned into multiple slices (Number of vertical blocks). After MD\_INIT, the output of first slice will be read through one register read operation and read pointer will be moved to the next slice. Host can issue read command until all the slices have been read. MD\_MAPO[0] maps to the first block in current slice.

# TW6865

Index		ADDR_P_DMA								Default
		[7]	[6]	[5]	[4]	[3]	[2]	[1]	[0]	
0x80	B3	ADDR_P_DMA0								0x00
	B2									0x00
	B1									0x00
	B0									0x00
0x88	B3	ADDR_P_DMA1								0x00
	B2									0x00
	B1									0x00
	B0									0x00
0x90	B3	ADDR_P_DMA2								0x00
	B2									0x00
	B1									0x00
	B0									0x00
0x98	B3	ADDR_P_DMA3								0x00
	B2									0x00
	B1									0x00
	B0									0x00

ADDR\_P\_DMA      B[31:0]    Start address of P-buffer for DMA Channel-0 ~ Channel-3.

# TW6865

Index		WHP_DMA							Default
		[7]	[6]	[5]	[4]	[3]	[2]	[1]	
0x81	B3	HEIGHT0[9:2]							0x3C
	B2	HEIGHT0[1:0]	LINE_WIDTH0[10:5]						0x2E
	B1	LINE_WIDTH0 [4:0]				ACTIVE_WIDTH0[10:8]			0xA5
	B0	ACTIVE_WIDTH0[7:0]							0xA0
0x89	B3	HEIGHT1[9:2]							0x3C
	B2	HEIGHT1[1:0]	LINE_WIDTH1[10:5]						0x2E
	B1	LINE_WIDTH1[4:0]				ACTIVE_WIDTH1[10:8]			0xA5
	B0	ACTIVE_WIDTH1[7:0]							0xA0
0x91	B3	HEIGHT2[9:2]							0x3C
	B2	HEIGHT2[1:0]	LINE_WIDTH2[10:5]						0x2E
	B1	LINE_WIDTH2[4:0]				ACTIVE_WIDTH2[10:8]			0xA5
	B0	ACTIVE_WIDTH2[7:0]							0xA0
0x99	B3	HEIGHT3[9:2]							0x3C
	B2	HEIGHT3[1:0]	LINE_WIDTH3[10:5]						0x2E
	B1	LINE_WIDTH3[4:0]				ACTIVE_WIDTH3[10:8]			0xA5
	B0	ACTIVE_WIDTH3[7:0]							0xA0

For DMA Channel-0~Channel-3:

**HEIGHT**                B[31:22]    Total active lines  
**LINE\_WIDTH**        B[21:11]    Total bytes per line  
**ACTIVE\_WIDTH**      B[10:0]     Total active bytes per line

# TW6865

Index		ADDR_B_DMA								Default
		[7]	[6]	[5]	[4]	[3]	[2]	[1]	[0]	
0x82	B3	ADDR_B_DMA0								0x00
	B2									0x00
	B1									0x00
	B0									0x00
0x8A	B3	ADDR_B_DMA1								0x00
	B2									0x00
	B1									0x00
	B0									0x00
0x92	B3	ADDR_B_DMA2								0x00
	B2									0x00
	B1									0x00
	B0									0x00

ADDR\_B\_DMA      B[31:0]    Start address of B-buffer for DMA Channel-0 ~ Channel-3.

# TW6865

Index		F2_ADDR_P_DMA								Default
		[7]	[6]	[5]	[4]	[3]	[2]	[1]	[0]	
0x84	B3	F2_ADDR_P_DMA0								0x00
	B2									0x00
	B1									0x00
	B0									0x00
0x8C	B3	F2_ADDR_P_DMA1								0x00
	B2									0x00
	B1									0x00
	B0									0x00
0x94	B3	F2_ADDR_P_DMA2								0x00
	B2									0x00
	B1									0x00
	B0									0x00
0x9C	B3	F2_ADDR_P_DMA3								0x00
	B2									0x00
	B1									0x00
	B0									0x00

**F2\_ADDR\_P\_DMA**    B[31:0]    Start address of Field 2 P-buffer for DMA Channel-0 ~ Channel-3.

# TW6865

Index		F2_WHP_DMA							Default
		[7]	[6]	[5]	[4]	[3]	[2]	[1]	
0x85	B3	F2_HEIGHT0[9:2]							0x3C
	B2	F2_HEIGHT0[1:0]	F2_LINE_WIDTH0[10:5]						0x2E
	B1	F2_LINE_WIDTH0 [4:0]				F2_ACTIVE_WIDTH0[10:8]			0xA5
	B0	F2_ACTIVE_WIDTH0[7:0]							0xA0
0x8D	B3	F2_HEIGHT1[9:2]							0x3C
	B2	F2_HEIGHT1[1:0]	F2_LINE_WIDTH1[10:5]						0x2E
	B1	F2_LINE_WIDTH1[4:0]				F2_ACTIVE_WIDTH1[10:8]			0xA5
	B0	F2_ACTIVE_WIDTH1[7:0]							0xA0
0x95	B3	F2_HEIGHT2[9:2]							0x3C
	B2	F2_HEIGHT2[1:0]	F2_LINE_WIDTH2[10:5]						0x2E
	B1	F2_LINE_WIDTH2[4:0]				F2_ACTIVE_WIDTH2[10:8]			0xA5
	B0	F2_ACTIVE_WIDTH2[7:0]							0xA0
0x9D	B3	F2_HEIGHT3[9:2]							0x3C
	B2	F2_HEIGHT3[1:0]	F2_LINE_WIDTH3[10:5]						0x2E
	B1	F2_LINE_WIDTH3[4:0]				F2_ACTIVE_WIDTH3[10:8]			0xA5
	B0	F2_ACTIVE_WIDTH3[7:0]							0xA0

For DMA Channel-0~Channel-3:

**F2\_HEIGHT**            B[31:22]    Total active lines in field 2  
**F2\_LINE\_WIDTH**        B[21:11]    Total bytes per line in field 2  
**F2\_ACTIVE\_WIDTH**      B[10:0]     Total active bytes per line in field 2



# TW6865

Index		F2_ADDR_B_DMA								Default
		[7]	[6]	[5]	[4]	[3]	[2]	[1]	[0]	
0x86	B3	F2_ADDR_B_DMA0								0x00
	B2									0x00
	B1									0x00
	B0									0x00
0x8E	B3	F2_ADDR_B_DMA1								0x00
	B2									0x00
	B1									0x00
	B0									0x00
0x96	B3	F2_ADDR_B_DMA2								0x00
	B2									0x00
	B1									0x00
	B0									0x00
0x9E	B3	F2_ADDR_B_DMA3								0x00
	B2									0x00
	B1									0x00
	B0									0x00

**F2\_ADDR\_P\_DMA**    B[31:0]    Start address of Field 2 B-buffer for DMA Channel-0 ~ Channel-3.

# TW6865

Index		RG_NRDET_CFG								Default
		[7]	[6]	[5]	[4]	[3]	[2]	[1]	[0]	
0xC0	B3	RG_NRDET_PARA3								0x14
	B2	RG_NRDET_PARA2								0x32
	B1	RG_NRDET_PARA1								0x3C
	B0	RG_NRDET_PARA0								0xAA
0xC1	B3	RG_NRDET_PARA7								0x14
	B2	RG_NRDET_PARA6								0x14
	B1	RG_NRDET_PARA5								0xA5
	B0	RG_NRDET_PARA4								0x28
0xC2	B3	RG_NRDET_PARA11								0x28
	B2	RG_NRDET_PARA10								0xA5
	B1	RG_NRDET_PARA9								0xAA
	B0	RG_NRDET_PARA8								0x0F
0xC3	B3	0	0	0	0	0	0	0	0	0x00
	B2	RG_NRDET_PARA14								0x0F
	B1	RG_NRDET_PARA13								0x14
	B0	RG_NRDET_PARA12								0xAA

## TW6865

Index		RG_NRDET_CFG							Default
		[7]	[6]	[5]	[4]	[3]	[2]	[1]	
0xC4	B3	RG_NR2D_THD4							0x0F
	B2	RG_NR2D_THD3							0x08
	B1	RG_NR2D_THD2							0x0A
	B0	RG_NR2D_THD1							0x05

These registers are used to configure NR2D detection thresholds.

# TW6865

Index	RG_NR_CTRL									Default
	[7]	[6]	[5]	[4]	[3]	[2]	[1]	[0]		
0xC8	B3	0	0	0	0	0	0	0	0	0x00
	B2	NR2D_ENA0	SKIP_CNT1	SKIP_CNT0	RGA_RST_NRDET0	RG_NRDET_CTL0				0x00
	B1	RG_FRONT_GEN_CTL0								0x00
	B0	RG_FRONT_CTL0								0x00
0xC9	B3	0	0	0	0	0	0	0	0	0x00
	B2	NR2D_ENA1	0	0	RGA_RST_NRDET1	RG_NRDET_CTL1				0x00
	B1	RG_FRONT_GEN_CTL1								0x00
	B0	RG_FRONT_CTL1								0x00
0xCA	B3	0	0	0	0	0	0	0	0	0x00
	B2	NR2D_ENA2	0	0	RGA_RST_NRDET2	RG_NRDET_CTL2				0x00
	B1	RG_FRONT_GEN_CTL2								0x00
	B0	RG_FRONT_CTL2								0x00
0xCB	B3	0	0	0	0	0	0	0	0	0x00
	B2	NR2D_ENA3	0	0	RGA_RST_NRDET3	RG_NRDET_CTL3				0x00
	B1	RG_FRONT_GEN_CTL3								0x00
	B0	RG_FRONT_CTL3								0x00

NR2D_ENA	B[23]	Enable 2D noise reduction 0: disable 1: enable
SKIP_CNT[1:0]	B[22:21]	Define how many fields to be skipped before processing.
RGA_RST_NRDET	B [20]	Reset noise detection
RG_NRDET_CTL	B [19:16]	Noise detection control
RG_FRONT_GEN_CTL	B [15:8]	Front control
RG_FRONT_CTL	B [7:0]	Front gen control

# TW6865

Index		PIN_CFG_CTRL								Default
		[7]	[6]	[5]	[4]	[3]	[2]	[1]	[0]	
0xFB	B3	0	0	0	0	0	0	0	0	0x00
	B2	ACH7 DTEST	ACH6 DTEST	ACH5 DTEST	ACH4 DTEST	ACH3 DTEST	ACH2 DTEST	ACH1 DTEST	ACH0 DTEST	0x00
	B1	0	0	0	0	VCH3 DTEST	VCH2 DTEST	VCH0 DTEST	VCH0 DTEST	0x00
	B0	0	0		0	0	0	Mode1	Mode0	0xA0

This register is cleared to default value only by hardware reset.

- ACHDTEST**            B[23:16]    Audio codec input data selection  
                           0 = From internal AFE  
                           1 = From external Pin
- VCHDTEST**            B[11:8]     Video Decoder input data selection  
                           0 = From internal AFE  
                           1 = From external Pin
- Mode**                 B[1:0]      Pin configuration  
                           0 = JTAG Enable  
                           1 = Debug Port Enable  
                           2 = Full GPIO  
                           3 = External ADC input data

# TW6865

Index		DBGPORT_CTRL								Default
		[7]	[6]	[5]	[4]	[3]	[2]	[1]	[0]	
0xFC	B3	0	0	0	0	0	0	0	0	0x00
	B2	0	0	0	0	0	0	0	0	0x00
	B1	MSB16_EN	BLOCK_SEL							0x00
	B0	SUBMODULE_SEL								0x00

MSB16\_EN            B[15]            Enable MSB 16 bits of debug signal at output ports  
0 = disable (so LSB 16 bits are wired to ports)  
1 = enable

BLOCK\_SEL            B[14:8]            Block selection for debug port output  
SUBMODULE\_SEL        B[7:0]            Sub-module of block selection

BLOCK_SEL	SUBMODULE_SEL	DEBUG PORTS
0	0x0	PIPE Interface
	0x1	PCIE EndPoint
	0x2	PCIE EndPoint
	0x3	Status of DMA Parser
	0x4	I2S Receiver
1	0x0	DMA_CH0
	0x1	DMA_CH1
	0x2	DMA_CH2
	0x3	DMA_CH3
	0x4	Reserved
	0x5	Reserved
	0x6	Reserved
	0x7	Reserved
	0x8	DMA_CH8
	0x9	DMA_CH9
	0xA	DMA_CH10
	0xB	DMA_CH11
	0xC	DMA_CH12
	0xD	DMA_CH13
	0xE	DMA_CH14
	0xF	DMA_CH15
2	0x10	Schedule
	0x11	MSI
	0x12	Client
	0x13	Cpl
	0x14	DMA_CH16
	0x0	Parser1
	0x1	Parser2
	0x2	Parser3
0x3	Parser4	
	0x4	Parser5
	0x5	Parser6
	0x6	Parser7
	0x7	Parser8

# TW6865

Index		EP_REG_ADDR								Default
		[7]	[6]	[5]	[4]	[3]	[2]	[1]	[0]	
0xFE	B3	0	0	0	0	0	0	0	0	0x00
	B2	0	0	0	0	0	0	0	0	0x00
	B1	0	0	0	0	EP_REG_ADDR				0x00
	B0	EP_REG_ADDR								0x00

EP\_REG\_ADDR      B[11:0]    Address of PCIE\_EP core register  
 Note: DWORD aligned

Index		EP_REG_DATA								Default
		[7]	[6]	[5]	[4]	[3]	[2]	[1]	[0]	
0xFF	B3	EP_REG_DATA								0x00
	B2									0x00
	B1									0x00
	B0									0x00

EP\_REG\_DATA      B[31:0]    Data read from or write to PCIE\_EP core register  
 Note:  
 (1) It must follow EP\_REG\_ADDR, and couldn't be used alone.  
 (2) Write steps:  
     (a) write target PCIE\_EP register address to "EP\_REG\_ADDR";  
     (b) write target data to "EP\_REG\_DATA".  
 (3) Read steps:  
     (a) write target PCIE\_EP register address to "EP\_REG\_ADDR";  
     (b) read data from "EP\_REG\_DATA".

# TW6865

## Video Decoder & Audio Codec (CH0 ~ CH3)

(Starting from 0x100)

(B[31:8] are hardwired to 0 in all registers)

Index				VIDEO STATUS REGISTER								Default
CH1	CH2	CH3	CH4	[7]	[6]	[5]	[4]	[3]	[2]	[1]	[0]	
0x100	0x110	0x120	0x130	VDLOSS	HLOCK	SLOCK	FIELD	VLOCK	0	MONO	DET50	0x00

**VDLOSS**      B[7]      1 = Video not present. (sync is not detected in number of consecutive line periods specified by MISSCNT register)  
0 = Video detected.

**HLOCK**      B[6]      1 = Horizontal sync PLL is locked to the incoming video source.  
0 = Horizontal sync PLL is not locked.

**SLOCK**      B[5]      1 = Sub-carrier PLL is locked to the incoming video source.  
0 = Sub-carrier PLL is not locked.

**FIELD**      B[4]      0 = Odd field is being decoded.  
1 = Even field is being decoded.

**VLOCK**      B[3]      1 = Vertical logic is locked to the incoming video source.  
0 = Vertical logic is not locked.

**MONO**      B[1]      1 = No color burst signal detected.  
0 = Color burst signal detected.

**DET50**      B[0]      0 = 60Hz source detected  
1 = 50Hz source detected  
The actual vertical scanning frequency depends on the current standard invoked.

Index				BRIGHTNESS Control Register								Default
CH1	CH2	CH3	CH4	[7]	[6]	[5]	[4]	[3]	[2]	[1]	[0]	
0x101	0x111	0x121	0x131	BRIGHT								0x00

**BRIGHT**      B[7:0]      These bits control the brightness. They have value of -128 to 127 in 2's complement form. Positive value increases brightness. A value 0 has no effect on the data.

Index				CONTRAST Control Register								Default
CH1	CH2	CH3	CH4	[7]	[6]	[5]	[4]	[3]	[2]	[1]	[0]	
0x102	0x112	0x122	0x132	CNTRST								0x64

**CNTRST**      B[7:0]      These bits control the contrast. They have value of 0 to 3.98 (FFh). A value of 1 (~ 100\_0000`) has no effect on the video data.



# TW6865

Index				SHARPNESS Control Register								Default
CH1	CH2	CH3	CH4	[7]	[6]	[5]	[4]	[3]	[2]	[1]	[0]	
0x103	0x113	0x123	0x133	SCURVE	VSF	CTI		SHARP				0x11

- SCURVE**      B[7]      This bit controls the center frequency of the peaking filter. The corresponding gain adjustment is HFLT.  
 0 = low  
 1 = center
- VSF**            B[6]      This bit is for internal used.
- CTI**            B[5:4]    CTI level selection. 0 = None. 3 = highest.
- SHARP**        B[3:0]    These bits control the amount of sharpness enhancement on the luminance signals. There are 16 levels of control with '0' having no effect on the output image. 1 through 15 provides sharpness enhancement with 'F' being the strongest.

Index				Chroma (U) Control Register								Default
CH1	CH2	CH3	CH4	[7]	[6]	[5]	[4]	[3]	[2]	[1]	[0]	
0x104	0x114	0x124	0x134	SAT_U								0x80

- SAT\_U**        B[7:0]    These bits control the digital gain adjustment to the U (or Cb) component of the digital video signal. The color saturation can be adjusted by adjusting the U and V color gain components by the same amount in the normal situation. The U and V can also be adjusted independently to provide greater flexibility. The range of adjustment is 0 to 200%.

Index				Chroma (V) Control Register								Default
CH1	CH2	CH3	CH4	[7]	[6]	[5]	[4]	[3]	[2]	[1]	[0]	
0x105	0x115	0x125	0x135	SAT_V								0x80

- SAT\_V**        B[7:0]    These bits control the digital gain adjustment to the V (or Cr) component of the digital video signal. The color saturation can be adjusted by adjusting the U and V color gain components by the same amount in the normal situation. The U and V can also be adjusted independently to provide greater flexibility. The range of adjustment is 0 to 200%.

Index				Hue Control Register								Default
CH1	CH2	CH3	CH4	[7]	[6]	[5]	[4]	[3]	[2]	[1]	[0]	
0x106	0x116	0x126	0x136	HUE								0x00

- HUE**            B[7:0]    These bits control the color hue as 2's complement number. They have value from +36° (7Fh) to -36° (80h) with an increment of 0.28°. The positive value gives greenish tone and negative value gives purplish tone. The default value is 0° (00h). This is effective only on NTSC system.

# TW6865

Index				Cropping Control Register								Default
CH1	CH2	CH3	CH4	[7]	[6]	[5]	[4]	[3]	[2]	[1]	[0]	
0x107	0x117	0x127	0x137	VDELAY_HI		VACTIVE_HI		HDELAY_HI		HACTIVE_HI		0x02

- VDELAY\_HI**     B[7:6]    These bits are bit 9 to 8 of the 10-bit Vertical Delay register.
- VACTIVE\_HI**   B[5:4]    These bits are bit 9 to 8 of the 10-bit VACTIVE register. Refer to description on Reg0x109 for its shadow register.
- HDELAY\_HI**     B[3:2]    These bits are bit 9 to 8 of the 10-bit Horizontal Delay register.
- HACTIVE\_HI**    B[1:0]    These bits are bit 9 to 8 of the 10-bit HACTIVE register.

Index				Vertical Delay Register Low								Default
CH1	CH2	CH3	CH4	[7]	[6]	[5]	[4]	[3]	[2]	[1]	[0]	
0x108	0x118	0x128	0x138	VDELAY_LO								0x12

- VDELAY\_LO**     B[7:0]    These bits are bit 7 to 0 of the 10-bit Vertical Delay register. The two MSBs are in the CROP\_HI register. It defines the number of lines between the leading edge of VSYNC and the start of the active video.

Index				Vertical Active Register Low								Default
CH1	CH2	CH3	CH4	[7]	[6]	[5]	[4]	[3]	[2]	[1]	[0]	
0x109	0x119	0x129	0x139	VACTIVE_LO								0xF0

- VACTIVE\_LO**    B[7:0]    These bits are bit 7 to 0 of the 10-bit Vertical Active register. The two MSBs are in the CROP\_HI register. It defines the number of active video lines per frame output.
- The VACTIVE register has a shadow register for use with 50Hz source when ATREG of Reg0x10E/11E/12E/13E is not set. This register can be accessed through the same index address by first changing the format standard to any 50Hz standard.

Index				Horizontal Delay Register Low								Default
CH1	CH2	CH3	CH4	[7]	[6]	[5]	[4]	[3]	[2]	[1]	[0]	
0x10A	0x11A	0x12A	0x13A	HDELAY_LO								0x0F

- HDELAY\_LO**     B[7:0]    These bits are bit 7 to 0 of the 10-bit Horizontal Delay register. The two MSBs are in the CROP\_HI register. It defines the number of pixels between the leading edge of the HSYNC and the start of the image cropping for active video.
- The HDELAY\_LO register has two shadow registers for use with PAL and SECAM sources respectively. These registers can be accessed using the same index address by first changing the decoding format to the corresponding standard.

# TW6865

Index				Horizontal Active Register Low								Default
CH1	CH2	CH3	CH4	[7]	[6]	[5]	[4]	[3]	[2]	[1]	[0]	
0x10B	0x11B	0x12B	0x13B	HACTIVE_LO								0x D0

**HACTIVE\_LO**    B[7:0]    These bits are bit 7 to 0 of the 10-bit Horizontal Active register. The two MSBs are in the CROP\_HI register. It defines the number of active pixels per line output.

Index				Macrovision Detection								Default
CH1	CH2	CH3	CH4	[7]	[6]	[5]	[4]	[3]	[2]	[1]	[0]	
0x10C	0x11C	0x12C	0x13C	SF*	PF*	FF*	KF*	CSBAD*	MVCSN*	CSTRIPE*	CTYPE*	0x00

**Read only register**

- SF**                    B[7]    This bit is for internal use.
- PF**                    B[6]    This bit is for internal use.
- FF**                    B[5]    This bit is for internal use.
- KF**                    B[4]    This bit is for internal use.
- CSBAD**              B[3]    1 = Macrovision color stripe detection may be un-reliable
- MVCSN**              B[2]    1 = Macrovision AGC pulse detected.  
0 = Not detected.
- CSTRIPE**            B[1]    1 = Macrovision color stripe protection burst detected.  
0 = Not detected.
- CTYPE**                B[0]    This bit is valid only when color stripe protection is detected, i.e. Cstripe=1.  
1 = Type 2 color stripe protection  
0 = Type 3 color stripe protection

Index				Chip STATUS II								Default
CH1	CH2	CH3	CH4	[7]	[6]	[5]	[4]	[3]	[2]	[1]	[0]	
0x10D	0x11D	0x12D	0x13D	VCR*	WKAIR*	WKAIR1*	VSTD*	NINTL*	RESERVED			0x00

**Read only register**

- VCR**                    B[7]    VCR signal indicator.
- WKAIR**                B[6]    Weak signal indicator 2.
- WKAIR1B[5]**        Weak signal indicator controlled by WKTH.
- VSTD**                B[4]    1 = Standard signal  
0 = Non-standard signal
- NINTL**                B[3]    1 = Non-interlaced signal  
0 = interlaced signal

## TW6865

Index				Standard Selection								Default
CH1	CH2	CH3	CH4	[7]	[6]	[5]	[4]	[3]	[2]	[1]	[0]	
0x10E	0x11E	0x12E	0x13E	DETSTATUS*	STDNOW*			ATREG	STD			0x07

<b>DETSTATUS</b>	<b>B[7]</b>	<p>0 = Idle</p> <p>1 = detection in progress</p>
<b>STDNOW</b>	<b>B[6:4]</b>	<p>Current standard invoked</p> <p>0 = NTSC(M)</p> <p>1 = PAL (B,D,G,H,I)</p> <p>2 = SECAM</p> <p>3 = NTSC4.43</p> <p>4 = PAL (M)</p> <p>5 = PAL (CN)</p> <p>6 = PAL 60</p> <p>7 = Not valid</p>
<b>ATREG</b>	<b>B[3]</b>	<p>1 = Disable the shadow registers.</p> <p>0 = Enable VACTIVE and HDELAY shadow registers value depending on standard</p>
<b>STD</b>	<b>B[2:0]</b>	<p>Standard selection</p> <p>0 = NTSC(M)</p> <p>1 = PAL (B,D,G,H,I)</p> <p>2 = SECAM</p> <p>3 = NTSC4.43</p> <p>4 = PAL (M)</p> <p>5 = PAL (CN)</p> <p>6 = PAL 60</p> <p>7 = Auto detection</p>

# TW6865

Index				Standard Recognition								Default
CH1	CH2	CH3	CH4	[7]	[6]	[5]	[4]	[3]	[2]	[1]	[0]	
0x10F	0x11F	0x12F	0x13F	ATSTART	PAL6_EN	PALN_EN	PALM_EN	NT44_EN	SEC_EN	PALB_EN	NTSC_EN	0x7F

- ATSTART**      B[7]      Writing 1 to this bit will manually initiate the auto format detection process. This bit is a self-resetting bit.
- PAL6\_EN**      B[6]      1 = enable recognition of PAL60.  
0 = disable recognition.
- PALN\_EN**      B[5]      1 = enable recognition of PAL (CN).  
0 = disable recognition.
- PALM\_EN**      B[4]      1 = enable recognition of PAL (M).  
0 = disable recognition.
- NT44\_EN**      B[3]      1 = enable recognition of NTSC 4.43.  
0 = disable recognition.
- SEC\_EN** B[2]      1 = enable recognition of SECAM.  
0 = disable recognition
- PALB\_EN**      B[1]      1 = enable recognition of PAL (B,D,G,H,I).  
0 = disable recognition
- NTSC\_EN**      B[0]      1 = enable recognition of NTSC (M).  
0 = disable recognition

Index				Vertical Scaling Register, Low								Default
CH1	CH2	CH3	CH4	[7]	[6]	[5]	[4]	[3]	[2]	[1]	[0]	
0x144	0x154	0x164	0x174	VSCALE_LO								0x00

**VSCALE\_LO**      B[7:0]      These bits are bit 7 to 0 of the 12-bit vertical scaling ratio register

Index				Scaling Register, High								Default
CH1	CH2	CH3	CH4	[7]	[6]	[5]	[4]	[3]	[2]	[1]	[0]	
0x145	0x155	0x165	0x175	VSCALE_HI				HSCALE_HI				0x11

- VSCALE\_HI**      B[7:4]      These bits are bit 11 to 8 of the 12-bit vertical scaling ratio register.
- HSCALE\_HI**      B[3:0]      These bits are bit 11 to 8 of the 12-bit horizontal scaling ratio register.

# TW6865

Index				Horizontal Scaling Register, Low								Default
CH1	CH2	CH3	CH4	[7]	[6]	[5]	[4]	[3]	[2]	[1]	[0]	
0x146	0x156	0x166	0x176	HSCALE_LO								0x00

**HSCALE\_LO**    B[7:0]    These bits are bit 7 to 0 of the 12-bit horizontal scaling ratio register.

Index				Cropping Control Register-Field 2								Default
CH1	CH2	CH3	CH4	[7]	[6]	[5]	[4]	[3]	[2]	[1]	[0]	
0x147	0x157	0x167	0x177	V2DELAY_HI		V2ACTIVE_HI		H2DELAY_HI		H2ACTIVE_HI		0x02

This register is for field 2 setting:

**V2DELAY\_HI**    B[7:6]    These bits are bit 9 to 8 of the 10-bit Vertical Delay register.

**V2ACTIVE\_HI**    B[5:4]    These bits are bit 9 to 8 of the 10-bit VACTIVE register.

**H2DELAY\_HI**    B[3:2]    These bits are bit 9 to 8 of the 10-bit Horizontal Delay register.

**H2ACTIVE\_HI**    B[1:0]    These bits are bit 9 to 8 of the 10-bit HACTIVE register.

Index				Vertical Delay Register Low-Field 2								Default
CH1	CH2	CH3	CH4	[7]	[6]	[5]	[4]	[3]	[2]	[1]	[0]	
0x148	0x158	0x168	0x178	V2DELAY_LO								0x12

This register is for field 2 setting:

**V2DELAY\_LO**    B[7:0]    These bits are bit 7 to 0 of the 10-bit Vertical Delay register. The two MSBs are in the CROP\_HI register. It defines the number of lines between the leading edge of VSYNC and the start of the active video.

# TW6865

Index				Vertical Active Register Low-Field 2								Default
CH1	CH2	CH3	CH4	[7]	[6]	[5]	[4]	[3]	[2]	[1]	[0]	
0x149	0x159	0x169	0x179	V2ACTIVE_LO								0xF0

This register is for field 2 setting:

**V2ACTIVE\_LO** B[7:0] These bits are bit 7 to 0 of the 10-bit Vertical Active register. The two MSBs are in the CROP\_HI register. It defines the number of active video lines per frame output.

Index				Horizontal Delay Register Low-Field2								Default
CH1	CH2	CH3	CH4	[7]	[6]	[5]	[4]	[3]	[2]	[1]	[0]	
0x14A	0x15A	0x16A	0x17A	H2DELAY_LO								0x0F

This register is for field 2 setting:

**H2DELAY\_LO** B[7:0] These bits are bit 7 to 0 of the 10-bit Horizontal Delay register. The two MSBs are in the CROP\_HI register. It defines the number of pixels between the leading edge of the HSYNC and the start of the image cropping for active video.

Index				Horizontal Active Register Low-Field 2								Default
CH1	CH2	CH3	CH4	[7]	[6]	[5]	[4]	[3]	[2]	[1]	[0]	
0x14B	0x15B	0x16B	0x17B	H2ACTIVE_LO								0xD0

This register is for field 2 setting:

**H2ACTIVE\_LO** B[7:0] These bits are bit 7 to 0 of the 10-bit Horizontal Active register. The two MSBs are in the CROP\_HI register. It defines the number of active pixels per line output.

Index				Vertical Scaling Register, Low-Field 2								Default
CH1	CH2	CH3	CH4	[7]	[6]	[5]	[4]	[3]	[2]	[1]	[0]	
0x14C	0x15C	0x16C	0x17C	V2SCALE_LO								0x00

This register is for field 2 setting:

**V2SCALE\_LO** B[7:0] These bits are bit 7 to 0 of the 12-bit vertical scaling ratio register

# TW6865

Index				Scaling Register, High- Field 2								Default
CH1	CH2	CH3	CH4	[7]	[6]	[5]	[4]	[3]	[2]	[1]	[0]	
0x14D	0x15D	0x16D	0x17D	V2SCALE_HI				H2SCALE_HI				0x11

This register is for field 2 setting:

V2SCALE\_HI B[7:4] These bits are bit 11 to 8 of the 12-bit vertical scaling ratio register.

H2SCALE\_HI B[3:0] These bits are bit 11 to 8 of the 12-bit horizontal scaling ratio register.

Index				Horizontal Scaling Register, Low-Field 2								Default
CH1	CH2	CH3	CH4	[7]	[6]	[5]	[4]	[3]	[2]	[1]	[0]	
0x14E	0x15E	0x16E	0x17E	H2SCALE_LO								0x00

This register is for field 2 setting:

H2SCALE\_LO B[7:0] These bits are bit 7 to 0 of the 12-bit horizontal scaling ratio register.

Index				F2CNT								Default
CH1	CH2	CH3	CH4	[7]	[6]	[5]	[4]	[3]	[2]	[1]	[0]	
0x14F	0x15F	0x16F	0x17F	0	0	0	0	0	0	0	F2CNT	0x00

F2CNT B[0] Field 2 configuration registers

0 = Field2 Video Capture Controlled by VDELAY, VACTIVE, HDELAY, HACTIVE, VSCALE, HSCALE registers.

1 = Field2 Video Capture Controlled by V2DELAY, V2ACTIVE, H2DELAY, and H2ACTIVE, V2SCALE, H2SCALE field2 registers

Index				RESERVED								Default
CH1	CH2	CH3	CH4	[7]	[6]	[5]	[4]	[3]	[2]	[1]	[0]	
0x1A0	0x1A1	0x1A2	0x1A3	0	RESERVED			RESERVED				0x08



## TW6865

Index				ID Detection Control								Default		
CH1	CH2	CH3	CH4	[7]	[6]	[5]	[4]	[3]	[2]	[1]	[0]			
0x1A4	0x1A5	0x1A6	0x1A7	IDX			NSEN					0x1A		
							SSEN					0x20		
							PSEN					0x1C		
							WKTH					0x11		

**IDX**            **B[7:6]**    These two bits indicate which of the four lower 6-bit registers is currently being controlled. The write sequence is a two steps process unless the same register is written. A write of {ID,000000} selects one of the four registers to be written. A subsequent write will actually write into the register.

**B[5:0]**

**NSEN**            **IDX = 0** controls the NTSC color carrier detection sensitivity (NSEN).

**SSEN**            **IDX = 1** controls the SECAM ID detection sensitivity (SSEN).

**PSEN**            **IDX = 2** controls the PAL ID detection sensitivity (PSEN).

**WKTH**            **IDX = 3** controls the weak signal detection sensitivity (WKTH).

## TW6865

Index	Software Reset Control Register								Default
	[7]	[6]	[5]	[4]	[3]	[2]	[1]	[0]	
0x180	0	0	0	AUDIORST	VDEC4RST	VDEC3RST	VDEC2RST	VDEC1RST	0x00

- AUDIORST**    B[4]    A 1 written to this bit resets the Audio portion to its default state but all register content remain unchanged. This bit is self-resetting.
- VDEC4RST**    B[3]    A 1 written to this bit resets the Video4 Decoder portion to its default state but all register content remain unchanged. This bit is self-resetting.
- VDEC3RST**    B[2]    A 1 written to this bit resets the Video3 Decoder portion to its default state but all register content remain unchanged. This bit is self-resetting.
- VDEC2RST**    B[1]    A 1 written to this bit resets the Video2 Decoder portion to its default state but all register content remain unchanged. This bit is self-resetting.
- VDEC1RST**    B[0]    A 1 written to this bit resets the Video1 Decoder portion to its default state but all register content remain unchanged. This bit is self-resetting.

## TW6865

Index	Analog Control Register								Default
	[7]	[6]	[5]	[4]	[3]	[2]	[1]	[0]	
0x181	RESERVED	IREF	VREF	RESERVED	CLKPDN	AINSWTEST	YFLEN	YSV	0x02

IREF	B[6]	0 = Internal current reference 1. 1 = Internal current reference increase 30%.
VREF	B[5]	0 = Internal voltage reference. 1 = Internal voltage reference shut down.
CLKPDNB[3]		0 = Normal clock operation. 1 = All 4Ch Video Decoder System clock in power down mode, but the MPU INTERFACE module and output clocks (CLKP and CLKN) are still active.
AINSWTEST	B[2]	0 = Normal operation(must be 0) 1 = AINSWTEST
YFLEN	B[1]	Analog Video CH1/CH2/CH3/CH4 anti-alias filter control 1 = enable 0 = disable
YSV	B[0]	Analog Video CH1/CH2/CH3/CH4 Reduced power mode 1 = enable 0 = disable

## TW6865

Index	Analog Control Reister2								Default
	[7]	[6]	[5]	[4]	[3]	[2]	[1]	[0]	
0x182	CTEST	YCLEN	CKIPOL	AFLTEN	GTEST	VLPF	CKLY	CKLC	0x10

CTEST	B[7]	Clamping control for debugging use.(Test purpose only)
YCLEN	B[6]	1 = Y channel clamp disabled(Test purpose only) 0 = Enabled.
CKIPOL	B[5]	27MHz clock output signal rise/fall timing. 0 = change by 54MHz clock output falling edge. 1 = change by 54MHz clock output rising edge.
AFLTEN	B[4]	1 = Analog Audio input Anti-Aliasing Filter enabled 0 = Disabled.( <b>must be 0 for no Audio Input cross-talk</b> ) (default)
GTEST	B[3]	1 = Test.(Test purpose only) 0 = Normal operation
VLPF	B[2]	Clamping filter control.
CKLY	B[1]	Clamping current control 1.
CKLC	B[0]	Clamping current control 2.

## TW6865

Index	Control Register I								Default
	[7]	[6]	[5]	[4]	[3]	[2]	[1]	[0]	
0x183	PBW	DEM	PALSW	SET7	COMB	HCOMP	YCOMB	PDLY	0xCC

<b>PBW</b>	<b>B[7]</b>	<b>1 = Wide Chroma BPF BW 0 = Normal Chroma BPF BW</b>
<b>DEM</b>	<b>B[6]</b>	<b>Reserved</b>
<b>PALSW</b>	<b>B[5]</b>	<b>1 = PAL switch sensitivity low. 0 = PAL switch sensitivity normal.</b>
<b>SET7</b>	<b>B[4]</b>	<b>1 = The black level is 7.5 IRE above the blank level. 0 = The black level is the same as the blank level.</b>
<b>COMB</b>	<b>B[3]</b>	<b>1 = Adaptive comb filter for NTSC and PAL(recommended). Not for SECAM. 0 = Notch filter. For SECAM</b>
<b>HCOMP</b>	<b>B[2]</b>	<b>1 = Adaptive comb filter for NTSC and PAL(recommended). Not for SECAM. 0 = Notch filter. For SECAM.</b>
<b>YCOMB</b>	<b>B[1]</b>	<b>1 = Bypass Comb filter when no burst presence 0 = No bypass</b>
<b>PDLY</b>	<b>B[0]</b>	<b>PAL delay line. 0 = enabled. 1 = disabled.</b>

Index	Color Killer Hysteresis Control Register								Default
	[7]	[6]	[5]	[4]	[3]	[2]	[1]	[0]	
0x184	GMEN	CKHY			HSDLY				0x00

<b>GMEN</b>	<b>B[7]</b>	<b>Reserved</b>
<b>CKHY</b>	<b>B[6:5]</b>	<b>Color killer hysteresis. 00b - fastest 01b - fast 10b - medium 11b - slow</b>
<b>HSDLY</b>	<b>B[4:0]</b>	<b>Reserved for test.</b>

# TW6865

Index	Vertical Sharpness								Default
	[7]	[6]	[5]	[4]	[3]	[2]	[1]	[0]	
0x185	SHCOR				RESERVED				0x80

**SHCOR B[7:4]** These bits provide coring function for the sharpness control.

Index	Coring Control Register								Default
	[7]	[6]	[5]	[4]	[3]	[2]	[1]	[0]	
0x186	CTCOR		CCOR		VCOR		CIF		0x44

**CTCOR B[7:6]** These bits control the coring for CTI.

**CCOR B[5:4]** These bits control the low level coring function for the Cb/Cr output.

**VCOR B[3:2]** These bits control the coring function of vertical peaking.

**CIF B[1:0]** These bits control the IF compensation level.

- 00b = None
- 01b = 1.5dB
- 10b = 3dB
- 11b = 6dB

Index	Clamping Gain								Default
	[7]	[6]	[5]	[4]	[3]	[2]	[1]	[0]	
0x187	CLPEND				CLPST				0x50

**CLPEND B[7:4]** These 4 bits set the end time of the clamping pulse. Its value should be larger than the value of CLPST.

**CLPST B[3:0]** These 4 bits set the start time of the clamping. It is referenced to PCLAMP position.

Index	Individual AGC Gain								Default
	[7]	[6]	[5]	[4]	[3]	[2]	[1]	[0]	
0x188	NMGAIN				WPGAIN			RESERVED	0x22

**NMGAIN B[7:4]** These bits control the normal AGC loop maximum correction value.

**WPGAIN B[3:0]** Peak AGC loop gain control.

# TW6865

Index	Individual AGC Gain								Default
	[7]	[6]	[5]	[4]	[3]	[2]	[1]	[0]	
0x189	RESERVED	FC27	VYCOMB	VCCOMB	VVBILINE				0x40

FC27        B[6]     1 = normal ITU-R656 operation  
                      0 = squared pixel mode

VYCOMB     B[5]     independent vscaler control

VCCOMB     B[4]     independent vscaler control

VVBILINE   B[3:0]   VBI line enable

Index	White Peak Threshold								Default
	[7]	[6]	[5]	[4]	[3]	[2]	[1]	[0]	
0x18A	PEAKWT								0xD8

PEAKWT     B[7:0]    These bits control the white peak detection threshold. Setting 'FF' can disable this function.

Index	Clamp level								Default
	[7]	[6]	[5]	[4]	[3]	[2]	[1]	[0]	
0x18B	CLMPLD	CLMPL							0xBC

CLMPLD     B[7]     0 = Clamping level is set by CLMPL.  
                      1 = Clamping level preset at 60d.

CLMPL       B[6:0]    These bits determine the clamping level of the Y channel.

Index	Sync Amplitude								Default
	[7]	[6]	[5]	[4]	[3]	[2]	[1]	[0]	
0x18C	SYNCTD	SYNCT							0xB8

SYNCTD B[7]    0 = Reference sync amplitude is set by SYNCT.

                      1 = Reference sync amplitude is preset to 38h.

SYNCT B[6:0]   These bits determine the standard sync pulse amplitude for AGC reference.

# TW6865

Index	Sync Miss Count Register								Default
	[7]	[6]	[5]	[4]	[3]	[2]	[1]	[0]	
0x18D	MISSCNT				HSWIN				0x44

- MISSCNT**      B[7:4] These bits set the threshold for horizontal sync miss count threshold.
- HSWIN**        B[3:0] These bits determine the VCR mode detection threshold.

Index	Clamp Position Register								Default
	[7]	[6]	[5]	[4]	[3]	[2]	[1]	[0]	
0x18E	PCLAMP								0x38

- PCLAMP**      B[7:0] These bits set the clamping position from the PLL sync edge

Index	Vertical Control I							Default	
	[7]	[6]	[5]	[4]	[3]	[2]	[1]		[0]
0x18F	VLCKI		VLCKO		VMODE	DETV	AFLD	VINT	0x00

- VLCKI**        B[7:6] Vertical lock in time.  
0 = fastest  
3 = slowest.
- VLCKO**        B[5:4] Vertical lock out time.  
0 = fastest  
3 = slowest.
- VMODE** B[3] This bit controls the vertical detection window.  
1 = search mode.  
0 = vertical count down mode.
- DETV**        B[2] 1 = recommended for special application only.  
0 = Normal Vsync logic
- AFLD**        B[1] Auto field generation control  
0 = Off  
1 = On
- VINT**        B[0] Vertical integration time control.  
1 = short  
0 = normal



# TW6865

Index	Vertical Control II								Default
	[7]	[6]	[5]	[4]	[3]	[2]	[1]	[0]	
0x190	BSHT				VSHT				0x00

**BSHT**      B[7:4]    Burst PLL center frequency control.

**VSHT**      B[3:0]    Vsync output delay control in the increment of half line length.

Index	Color Killer Level Control								Default
	[7]	[6]	[5]	[4]	[3]	[2]	[1]	[0]	
0x191	CKILMAX				CKILMIN				0x78

**CKILMAX**    B[7:5]    These bits control the amount of color killer hysteresis. The hysteresis amount is proportional to the value.

**CKILMIN**    B[4:0]    These bits control the color killer threshold. Larger value gives lower killer level.

Index	Comb Filter Control								Default
	[7]	[6]	[5]	[4]	[3]	[2]	[1]	[0]	
0x192	HTL_MD	HTL			VTL				0x44

**HTL\_MDB[7]**    0 = adaptive mode  
                           1 = fixed comb

**HTL**            B[6:4]    Adaptive Comb filter threshold control 1.

**VTL**            B[3:0]    Adaptive Comb filter threshold control 2.

Index	Luma Delay and H Filter Control								Default
	[7]	[6]	[5]	[4]	[3]	[2]	[1]	[0]	
0x193	CKLM	YDLY			0	ASAVE	BP	HPF_RES	0x30

**CKLM**            B[7]      Color Killer mode  
                           0 = normal  
                           1 = fast (for special application)

**YDLY**            B[6:4]    Luma delay fine adjustment. This 2's complement number provides -4 to +3 unit delay control.

**ASAVE**          B[2]      Audio ADC power saving control

**BP**                B[1]      Audio ADC input buffer bypass

**HPF\_RES**        B[0]      Audio ADC High Pass Filter Resistance Control

## TW6865

Index	Miscellaneous Control I								Default
	[7]	[6]	[5]	[4]	[3]	[2]	[1]	[0]	
0x194	HPLC	EVCNT	PALC	SDET	TBC_EN	BYPASS	SYOUT	RESERVED	0x14

HPLC	B[7]	Reserved for internal use.
EVCNT	B[6]	1 = Even field counter in special mode. 0 = Normal operation
PALC	B[5]	Reserved for future use.
SDET	B[4]	ID detection sensitivity. A '1' is recommended.
TBC_EN	B[3]	1 = Internal TBC enable. Total pixel per line on Video active line is always 858x2 for NTSC/PAL-M(60Hz) and 864x2 for PAL/SECAM(50Hz). 0 = TBC off.
BYPASS	B[2]	It controls the standard detection and should be set to '1' in normal use.
SYOUT	B[1]	1 = Hsync output is disabled when video loss is detected 0 = Hsync output is always enabled

Index	LOOP Control Register								Default
	[7]	[6]	[5]	[4]	[3]	[2]	[1]	[0]	
0x195	HPM		ACCT		SPM				0xA5

HPM	B[7:6]	Horizontal PLL acquisition time. 0 = Normal; 1 = Auto2; 2 = Auto1; 3 = Fast
ACCT	B[5:4]	ACC time constant 0 = No ACC; 1 = slow; 2 = medium; 3 = fast
SPM	B[3:2]	Burst PLL control. 0 = Slowest; 1 = Slow; 2 = Fast; 3 = Fastest
CBW	B[1:0]	Chroma low pass filter bandwidth control. Refer to filter curves.

# TW6865

Index	Miscellaneous Control II								Default
	[7]	[6]	[5]	[4]	[3]	[2]	[1]	[0]	
0x196	NKILL	PKILL	SKILL	CBAL	FCS	LCS	CCS	BST	0xE0

- NKILL**      B[7]      1 = Enable noisy signal color killer function in NTSC mode.  
0 = Disabled.
- PKILL**      B[6]      1 = Enable automatic noisy color killer function in PAL mode.  
0 = Disabled.
- SKILL**      B[5]      1 = Enable automatic noisy color killer function in SECAM mode.  
0 = Disabled.
- CBAL**        B[4]      0 = Normal output  
1 = special output mode.
- FCS**         B[3]      1 = Force decoder output value determined by CCS.  
0 = Disabled.
- LCS**         B[2]      1 = Enable pre-determined output value indicated by CCS when  
video loss is detected.  
0 = Disabled.
- CCS**         B[1]      When FCS is set high or video loss condition is detected when LCS  
is set high, one of two colors display can be selected.  
1 = Blue color.  
0 = Black.
- BST**         B[0]      1 = Enable blue stretch.  
0 = Disabled.

Index	Miscellaneous Control II								Default
	[7]	[6]	[5]	[4]	[3]	[2]	[1]	[0]	
0x197	FRM		YNR		CLMD		PSP		0x05

- FRM**         B[7:6]    Free run mode control  
0 = Auto            2 = default to 60Hz      3 = default to 50Hz
- YNR**         B[5:4]    Y HF noise reduction  
0 = None            1 = smallest      2 = small          3 = medium
- CLMD**        B[3:2]    Clamping mode control.  
0 = Sync top      1 = Auto            2 = Pedestal      3 = N/A
- PSP**         B[1:0]    Slice level control  
0 = low            1 = medium      2 = high

# TW6865

Index	Horizontal Scaler Pre-filter Control								Default
	[7]	[6]	[5]	[4]	[3]	[2]	[1]	[0]	
0x1A8	HFLT2				HFLT1				0x00
0x1A9	HFLT4				HFLT3				0x00

**HFLT** Pre-filter selection for Video CH1/CH2/CH3/CH4 horizontal scaler  
 If HSCALE[11-8]=1,HFLT [3:0] controls the peaking function.  
 If HSCALE[11-8]>1,HFLT [2:0] function is below.  
     1\*\* = Bypass  
     000 = Auto selection based on Horizontal scaling ratio. (default)  
     001 = Recommended for CIF size image  
     010 = Recommended for QCIF size image  
     011 = Recommended for ICON size image

Index	Video AGC Control								Default
	[7]	[6]	[5]	[4]	[3]	[2]	[1]	[0]	
0x1AA	AGCEN4	AGCEN3	AGCEN2	AGCEN1	AGCGAIN4 [8]	AGCGAIN3 [8]	AGCGAIN2 [8]	AGCGAIN1 [8]	0x00
0x1AB	AGCGAIN1[7:0]								0xF0
0x1AC	AGCGAIN2[7:0]								0xF0
0x1AD	AGCGAIN3[7:0]								0xF0
0x1AE	AGCGAIN4[7:0]								0xF0

**AGCEN** Select Video AGC loop function on AIN1 ~ AIN4  
 0 = AGC loop function enabled (recommended for most application cases) (default)  
 1 = AGC loop function disabled. Gain is set by AGCGAIN1~4

**AGCGAIN** These registers control the AGC gain when AGC loop is disabled.  
 Default value is 0xF0.

## TW6865

Index	Vertical Peaking Level Control								Default
	[7]	[6]	[5]	[4]	[3]	[2]	[1]	[0]	
0x1AF	RESERVED	VSHP2			RESERVED	VSHP1			0x00
0x1B0	RESERVED	VSHP4			RESERVED	VSHP3			0x00

**VSHP**                      Select Video Vertical peaking level. (\*)  
                                  0    none. (default)  
                                  7    highest

\*Note: VSHP must be set to '0' if Reg0x183 COMB = 0.

Index	Audio ADC Digital Input Offset Control								Default
	[7]	[6]	[5]	[4]	[3]	[2]	[1]	[0]	
0x1B3	AADC40FS[9:8]		AADC30FS[9:8]		AADC20FS[9:8]		AADC10FS[9:8]		0x00
0x1B4	AADC10FS[7:0]								0x00
0x1B5	AADC20FS[7:0]								0x00
0x1B6	AADC30FS[7:0]								0x00
0x1B7	AADC40FS[7:0]								0x00

Digital ADC input data offset control. Digital ADC input data is adjusted by

$$ADJAADCn = AUDnADC + AADCnOFS.$$

AUDnADC is 2's formatted Analog Audio ADC output.

AADCnOFS is adjusted offset value by 2's format.

Index	Analog Audio ADC Digital Output Value								Default
	[7]	[6]	[5]	[4]	[3]	[2]	[1]	[0]	
0x1B8	AUD4ADC[9:8]*		AUD3ADC[9:8]*		AUD2ADC[9:8]*		AUD1ADC[9:8]*		0x00
0x1B9	AUD1ADC[7:0]*								0x00
0x1BA	AUD2ADC[7:0]*								0x00
0x1BB	AUD3ADC[7:0]*								0x00
0x1BC	AUD4ADC[7:0]*								0x00

These bits are read only.

AUDnADC shows current Analog Audio n ADC Digital Output Value by 2's format.

# TW6865

Index	Adjusted Analog Audio ADC Digital input Value								Default
	[7]	[6]	[5]	[4]	[3]	[2]	[1]	[0]	
0x1BD	ADJAADC4[9:8]*		ADJAADC3[9:8]*		ADJAADC2[9:8]*		ADJAADC1[9:8]*		0x00
0x1BE	ADJAADC1[7:0]*								0x00
0x1BF	ADJAADC2[7:0]*								0x00
0x1C0	ADJAADC3[7:0]*								0x00
0x1C1	ADJAADC4[7:0]*								0x00

These bits are read only.

ADJAADCn shows current adjusted Audio ADC Digital input data value by 2's format. These value show the first input data value in front of Digital Audio Decimation Filtering process.

Index	Analog Power Down								Default
	[7]	[6]	[5]	[4]	[3]	[2]	[1]	[0]	
0x1CE	AAUTOMUTE	RESERVED	RESERVED	A_ADC_PWDN	V_ADC_PWDN				0x00

- AAUTOMUTE**      B[7]      **1** = When input Analog data is less than ADET\_TH level, output PCM data will be 0x0000(0x00).Audio DAC data input is 0x200.  
**0** = No effect (default)
- A\_ADC\_PWDN**      B[4]      Power down the audio ADC  
**0** = Normal operation (default)  
**1** = Power down
- V\_ADC\_PWDN**      B[3:0]      Power down the video ADC  
V\_ADC\_PWDN[3:0] stands for CH4 to CH1.  
**0** = Normal operation (default)  
**1** = Power down

Index	Analog Audio Input Gain								Default	
	[7]	[6]	[5]	[4]	[3]	[2]	[1]	[0]		
0x1D0	0	AIGAIN1								0x20
0x1D1	0	AIGAIN2								0x20
0x1D2	0	AIGAIN3								0x20
0x1D3	0	AIGAIN4								0x20

- AIGAIN**      Select the amplifier's gain for each analog audio input AIN1 ~ AIN4.  
Gain Steps: 128  
Gain Range: 0.5~2.484375  
Gain Step Size: 0.015625  
Gain Default : 1.00

## TW6865

Index	Mix Mute Control								Default
	[7]	[6]	[5]	[4]	[3]	[2]	[1]	[0]	
0x1DC	LAWMD		MIX_DERATIO	MIX_MUTE					0x00

- LAWMD**            B[7:6]    Select u-Law/A-Law/PCM/SB data output format on ADATR and ADATM pin.  
 0 = PCM output (default)  
 1 = SB(Signed MSB bit in PCM data is inverted) output  
 2 = u-Law output  
 3 = A-Law output
- MIX\_DERATIO**    B[5]      Disable the mixing ratio value for all audio.  
 0 = Apply individual mixing ratio value for each audio (default)  
 1 = Apply nominal value for all audio commonly
- MIX\_MUTE**        B[3:0]    Enable the mute function for each audio. It effects only for mixing.  
 MIX\_MUTE[0] : Audio input AIN1.  
 MIX\_MUTE[1] : Audio input AIN2.  
 MIX\_MUTE[2] : Audio input AIN3.  
 MIX\_MUTE[3] : Audio input AIN4.  
 MIX\_MUTE[4] : Playback audio input.  
 It effects only for single chip or the last stage chip  
 0 = Normal (default)  
 1 = Muted

## TW6865

Index	Mix Ratio Value								Default
	[7]	[6]	[5]	[4]	[3]	[2]	[1]	[0]	
0x1DD	MIX_RATIO2				MIX_RATIO1				0x00
0x1DE	MIX_RATIO4				MIX_RATIO3				0x00

### MIX\_RATIO

Define the ratio values for audio mixing.

MIX\_RATIO1 : Audio input AIN1.

MIX\_RATIO2 : Audio input AIN2.

MIX\_RATIO3 : Audio input AIN3.

MIX\_RATIO4 : Audio input AIN4.

It effects only for single chip or the last stage chip.

0 0.25(Recommended for more than 4x AIN1/AIN2/AIN3/AIN4) (default)

1 0.31

2 0.38

3 0.44

4 0.50

5 0.63

6 0.75

7 0.88

8 1.00

9 1.25

10 1.50

11 1.75

12 2.00

13 2.25

14 2.50

15 2.75



# TW6865

Index	Mix Output Selection							Default
	[7]	[6]	[5]	[4]	[3]	[2]	[1]	
0x1E0	VADCCK POL	AADCCK POL	ADACCK POL	MIX_OUTSEL				0x14

VADCCKPOL	B[7]	Test purpose only. 0 (default)
AADCCKPOL	B[6]	Test purpose only. 0 (default)
ADACCKPOL	B[5]	Test purpose only. 0 (default)
MIX_OUTSEL	B[4:0]	Define the final audio output for analog and digital mixing out. 0    Select record audio of channel 1 1    Select record audio of channel 2 2    Select record audio of channel 3 3    Select record audio of channel 4 4    Select record audio of channel 5 5    Select record audio of channel 6 6    Select record audio of channel 7 7    Select record audio of channel 8 8    Select record audio of channel 9 9    Select record audio of channel 10 10   Select record audio of channel 11 11   Select record audio of channel 12 12   Select record audio of channel 13 13   Select record audio of channel 14 14   Select record audio of channel 15 15   Select record audio of channel 16 16   Select playback audio of the first stage chip 17   Select playback audio of the second stage chip 18   Select playback audio of the third stage chip 19   Select playback audio of the last stage chip 20   Select mixed audio (default)

# TW6865

Index	Audio Detection Period								Default
	[7]	[6]	[5]	[4]	[3]	[2]	[1]	[0]	
0x1E1	AAMPMD	ADET_FILTER			ADET_TH4[4]	ADET_TH3[4]	ADET_TH2[4]	ADET_TH1[4]	0xC0

**AAMPMD**            B[7]        Define the audio detection method.  
 0 = Detect audio if absolute amplitude is greater than threshold (default)  
 1 = Detect audio if differential amplitude is greater than threshold

**ADET\_FILTER**        B[6:5]      Select the filter for audio detection  
 0 = Wide LPF (default)  
 .....  
 7 = Narrow LPF

Index	Audio Detection Threshold								Default
	[7]	[6]	[5]	[4]	[3]	[2]	[1]	[0]	
0x1E1	AAMPMD	ADET_FILTER			ADET_TH4[4]	ADET_TH3[4]	ADET_TH2[4]	ADET_TH1[4]	0xC0
0x1E2	ADET_TH2[3:0]				ADET_TH1[3:0]				0xAA
0x1E3	ADET_TH4[3:0]				ADET_TH3[3:0]				0xAA

**ADET\_TH**            Define the threshold value for audio detection.  
 ADET\_TH1: Audio input AIN1.  
 ADET\_TH2: Audio input AIN2.  
 ADET\_TH3: Audio input AIN3.  
 ADET\_TH4: Audio input AIN4.  
 0            Low value (default)  
 .  
 .  
 31    High value

If fs=8kHz Audio Clock setting mode:  
 Reg0x1E1=0xC0, Reg0x1E2=0xAA, Reg0x1E3=0xAA are typical setting value.  
 If fs=16kHz/32kHz/44.1kHz/48kHz Audio Clock setting mode:  
 Reg0x1E1=0xE0, Reg0x1E2=0xBB, Reg0x1E3=0xBB are typical setting value.

# TW6865

Index	AADC_TEST								Default
	[7]	[6]	[5]	[4]	[3]	[2]	[1]	[0]	
0x1FC	0	ASYN SERIAL	AADC_PFTST	AINSW FIX	AINSW NUM				0x00

Audio ADC test controls These bits are not for normal usage

Index	VADC_TEST								Default
	[7]	[6]	[5]	[4]	[3]	[2]	[1]	[0]	
0x1FD	0	0	0	0	0	VADC_PFTST	VADC_PFSEL		0x00

Video ADC test controls These bits are not for normal usage

Index	Device ID								Default
	[7]	[6]	[5]	[4]	[3]	[2]	[1]	[0]	
0x1FE	DEV_ID[5:4]*: 0h		0	0	0	0	0	0	0x00
0x1FF	DEV_ID[3:0]*: 7h				0	0	0	1	0x71

DEV\_ID                      Device ID (0x07)

# TW6865

## PCIe Endpoint Controller

Offset		EP_HEADER_REG0								Default
		[7]	[6]	[5]	[4]	[3]	[2]	[1]	[0]	
0x00	B3	DEVICE_ID								0x68
	B2									0x64
	B1	VENDOR_ID								0x17
	B0									0x97

DEVICE_ID	B[31:16]	Device ID
VENDOR_ID	B[15: 0]	Vendor ID

## TW6865

Offset		EP_HEADER_REG1								Default
		[7]	[6]	[5]	[4]	[3]	[2]	[1]	[0]	
0x04	B3	STATUS_REG								0x00
	B2									0x10
	B1	COMMAND_REG								0x00
	B0									0x00

STATUS_REG	B[31]	Detected parity error
	B[30]	Signaled system error
	B[29]	Received master abort
	B[28]	Received target abort
	B[27]	Signaled target abort
	B[26:25]	2'b00
	B[24]	Master data parity error
	B[23:21]	3'b000
	B[20]	Capabilities list. Indicates presence of an extended capability item. Hardwired to 1
	B[19]	INTx status
	B[18:16]	Reserved
COMMAND_REG	B[15:11]	Reserved
	B[10]	INTx assertion disable
	B[9]	1'b0
	B[8]	SERR# enable
	B[7]	1'b0
	B[6]	Parity error response
	B[5:3]	3'b000
	B[2]	Bus master enable
	B[1]	Memory space enable
	B[0]	I/O space enable

# TW6865

Offset		EP_HEADER_REG2								Default
		[7]	[6]	[5]	[4]	[3]	[2]	[1]	[0]	
0x08	B3	CLASS_CODE								0x00
	B2									0x00
	B1									0x00
	B0									0x01

**CLASS\_CODE**      B[31:24] Base class code  
                       B[23:16] Subclass code  
                       B[15:8] Programming interface

**REVISION\_ID**      B[7:0] Revision ID

Offset		EP_HEADER_REG3								Default
		[7]	[6]	[5]	[4]	[3]	[2]	[1]	[0]	
0x0C	B3	BIST								0x00
	B2	HEADER_TYPE								0x00
	B1	LATENCY_TIMER								0x00
	B0	CACHE_LINE_SIZE								0x00

**BIST**                B[31:24] 8'h00

**HEADER\_TYPE**      B[23] 1'b0  
                       B[22:16] Configuration header format (hardwired to 0 for type 0.)

**LATENCY\_TIMER**    B[15:8] 8'h00

**CACHE\_LINE\_SIZE** B[7:0] 8'h00

## TW6865

Offset		EP_HEADER_REG4~ EP_HEADER_REG9								Default
		[7]	[6]	[5]	[4]	[3]	[2]	[1]	[0]	
0x10	B3	BASE_ADDRESS_REG0								0x00
	B2									0x00
	B1									0x00
	B0									0x08
0x14	B3	BASE_ADDRESS_REG1								0x00
	B2									0x00
	B1									0x00
	B0									0x00
0x18	B3	BASE_ADDRESS_REG2								0x00
	B2									0x00
	B1									0x00
	B0									0x00
0x1C	B3	BASE_ADDRESS_REG3								0x00
	B2									0x00
	B1									0x00
	B0									0x00
0x20	B3	BASE_ADDRESS_REG4								0x00
	B2									0x00
	B1									0x00
	B0									0x00
0x24	B3	BASE_ADDRESS_REG5								0x00
	B2									0x00
	B1									0x00
	B0									0x00

**BASE\_ADDRESS**

**B[31:4]** BAR base address bits

**B[3]** If BAR is a memory BAR, bit 3 indicates if the memory region is prefetchable:  
 0 = Non-prefetchable  
 1 = Prefetchable  
 If BAR is an I/O BAR, bit 3 is the second least significant bit of the base address.

**B[2:1]** 2'b00

**B[0]** 0 = BAR is a memory BAR  
 1 = BAR is an I/O BAR

# TW6865

Offset		EP_HEADER_REGA								Default
		[7]	[6]	[5]	[4]	[3]	[2]	[1]	[0]	
0x28	B3	CARDBUS_CIS_POINTER								0x00
	B2									0x00
	B1									0x00
	B0									0x00

CARDBUS\_CIS\_POINTER    B[31:0]                      CardBus CIS pointer

Offset		EP_HEADER_REGB								Default
		[7]	[6]	[5]	[4]	[3]	[2]	[1]	[0]	
0x2C	B3	SUBSYSTEM_ID								0x00
	B2									0x00
	B1	SUBSYSTEM_VENDOR_ID								0x00
	B0									0x00

SUBSYSTEM\_ID                                      B[31:16]Subsystem ID  
 SUBSYSTEM\_VENDOR\_ID    B[15:0]                                      Subsystem Vendor ID

Index		EP_HEADER_REGC								Default
		[7]	[6]	[5]	[4]	[3]	[2]	[1]	[0]	
0x30	B3	EXPANSION_ROM_BASE_ADDR								0x00
	B2									0x00
	B1									0x00
	B0									0x00

EXPANSION\_ROM\_BASE\_ADDR  
     B[31:11]Expansion ROM Address  
     B[10:1]                      Reserved  
     B[0]                              Expansion ROM Enable



## TW6865

Offset		EP_HEADER_REGD								Default
		[7]	[6]	[5]	[4]	[3]	[2]	[1]	[0]	
0x34	B3	CAP_PTR								0x00
	B2									0x00
	B1									0x00
	B0									0x40

**CAP\_PTR**                    B[7:0]     First capability pointer. Points to Power Management Capability structure by default.

Offset		EP_HEADER_REGF								Default
		[7]	[6]	[5]	[4]	[3]	[2]	[1]	[0]	
0x3C	B3	RESERVED								0x00
	B2	RESERVED								0x00
	B1	INTERRUPT_PIN								0x01
	B0	INTERRUPT_LINE								0xFF

**INTERRUPT\_PIN**            B[15:8]     Interrupt pin. Identifies the legacy interrupt Message that the device (or device function) uses.  
 01h: The device (or function) uses INTA  
 02h: The device (or function) uses INTB  
 03h: The device (or function) uses INTC  
 04h: The device (or function) uses INTD

**INTERRUPT\_LINE**        B[7:0]     Interrupt line

# TW6865

Offset		EP_PM_CAP_REGO								Default
		[7]	[6]	[5]	[4]	[3]	[2]	[1]	[0]	
0x40	B3	PMC								0xC9
	B2									0xC3
	B1	NEXT_CAP_POINTER								0x50
	B0	CAP_ID								0x01

**PMC**

**Power Management Capabilities Register**

**B[31:27] PME\_Support**

Identifies the power states from which the EP Controller can generate PME Messages. A value of 0 for any bit indicates that the device (or function) is not capable of generating PME Messages while in that power state:

- Bit 27: If set, PME Messages can be generated from D0
- Bit 28: If set, PME Messages can be generated from D1
- Bit 29: If set, PME Messages can be generated from D2
- Bit 30: If set, PME Messages can be generated from D3hot
- Bit 31: If set, PME Messages can be generated from D3cold

**B[26] D2 Support**

**B[25] D1 Support**

**B[24:22] AUX Current**

**B[21] Device Specific Initialization (DSI)**

**B[20] Reserved**

**B[19] PME Clock (1'b0)**

**B[18:16] Power Management Specification Version**

**NEXT\_CAP\_POINTER**    **B[15:8]**    Next capability pointer

**CAP\_ID**                    **B[7:0]**    Power Management capability ID

# TW6865

Offset		EP_PM_CAP_REG1								Default
		[7]	[6]	[5]	[4]	[3]	[2]	[1]	[0]	
0x44	B3	DATA								0x00
	B2	PMCSR_BSE_EXT								0x00
	B1	PMCSR								0x00
	B0									0x00

DATA                    B[31:24] 8'h00

PMCSR\_BSE\_EXT        B[23]     Bus Power/Clock Control enable (hardwired to 0)  
                           B[22]     B2/B3 support (hardwired to 0)  
                           B[21:16] Reserved

PMCSR                 B[15]     PME status  
                           B[14:13] Data scale (not supported)  
                           B[12:9]   Data select (not supported)  
                           B[8]      PME enable. A value of 1 indicates that the device is enabled  
     to generate PME  
                           B[7:4]     Reserved  
                           B[3]      No soft reset  
                           B[2]      Reserved  
                           B[1:0]     Power state  
     Controls the device power state:  
     00b: D0  
     01b: D1  
     10b: D2  
     11b: D3

# TW6865

Offset		EP_PCIE_CAP_REG0								Default								
		[7]	[6]	[5]	[4]	[3]	[2]	[1]	[0]									
0x70	B3	PCIE_CAP_REG								0x00								
	B2									0x12								
	B1									NEXT_CAP_POINTER								0x00
	B0									CAP_ID								0x10

**PCIE\_CAP\_REG**  
 B[31:30] Reserved  
 B[29:25] Interrupt message number  
 B[24] Slot implemented (it must 0 for an EP device.)  
 B[23:20] Device port type  
 B[19:16] PCI Express capability version

**NEXT\_CAP\_POINTER** B[15:8] Next capability pointer

**CAP\_ID** B[7:0] PCI Express capability ID

Offset		EP_PCIE_CAP_REG1								Default
		[7]	[6]	[5]	[4]	[3]	[2]	[1]	[0]	
0x74	B3	DEVICE_CAP								0x00
	B2									0x00
	B1									0x87
	B0									0x22

**DEVICE\_CAP**  
 B[31:28] Reserved  
 B[27:26] Captured slot power limit scale. From Message from RC, upstream port only.  
 B[25:18] Captured slot power limit value. From Message from RC, upstream port only.  
 B[17:16] Reserved  
 B[15] Role-Based error reporting  
 B[14:12] 3'b000  
 B[11:9] Endpoint L1 acceptable latency  
 B[8:6] Endpoint L0s acceptable latency  
 B[5] Extended tag field supported  
 B[4:3] Phantom function supported (must be 0)  
 B[2:0] Max\_Payload\_Size supported

# TW6865

Offset		EP_PCIE_CAP_REG2								Default
		[7]	[6]	[5]	[4]	[3]	[2]	[1]	[0]	
0x78	B3	DEVICE_STATUS								0x00
	B2									0x10
	B1	DEVICE_CONTROL								0x20
	B0									0x10

**DEVICE\_STATUS**

B[31:22] Reserved

B[21] Transaction pending  
Set to 1 when Non-Posted Requests are not yet completed and clear when they are completed.

B[20] Aux power detected  
Set to 1 if Aux power detected.

B[19] Unsupported request detected  
Errors are logged in this register regardless of whether error reporting is enabled in the Device Control register.

B[18] Fatal error detected  
Errors are logged in this register regardless of whether error reporting is enabled in the Device Control register.

B[17] Non-Fatal error detected  
Errors are logged in this register regardless of whether error reporting is enabled in the Device Control register.

B[16] Correctable error detected  
Errors are logged in this register regardless of whether error reporting is enabled in the Device Control register.

**DEVICE\_CONTROL**

B[15] Reserved

B[14:12] Max\_Read\_Request\_Size

B[11] Enable no snoop

B[10] AUX power PM enable

B[9] Phantom function enable

B[8] Extended tag field enable

B[7:5] Max\_Payload\_Size

B[4] Enable relaxed ordering

B[3] Unsupported request reporting enable

B[2] Fatal error reporting enable

B[1] Non-Fatal error reporting enable

B[0] Correctable error reporting enable

# TW6865

Offset		EP_PCIE_CAP_REG3								Default
		[7]	[6]	[5]	[4]	[3]	[2]	[1]	[0]	
0x7C	B3	LINK_CAP								0x00
	B2									0x07
	B1									0x3C
	B0									0x11

- LINK\_CAP**
- B[31:24] Port number
  - B[23:22] Reserved
  - B[21] Link bandwidth notification capability  
Set to 1 for Endpoint devices.
  - B[20] Data Link Layer active reporting capable  
Set to 1 for Endpoint devices.
  - B[19] Surprise down error reporting capable  
Not supported, hardwired to 0x0
  - B[18] Clock power management
  - B[17:15] L1 exit latency
  - B[14:12] L0s exit latency
  - B[11:10] Active state link PM support
  - B[9:4] Maximum link width
  - B[3:0] Maximum link speed

# TW6865

Offset		EP_PCIE_CAP_REG4								Default
		[7]	[6]	[5]	[4]	[3]	[2]	[1]	[0]	
0x80	B3	LINK_STATUS								0x10
	B2									0x11
	B1	LINK_CONTROL								0x00
	B0									0x00

- LINK\_STATUS**
- B[31] Link autonomous bandwidth status
  - B[30] Link bandwidth management status
  - B[29] Data Link Layer active (hardwired to 0)
  - B[28] Slot clock configuration
  - B[27] Link training (hardwired to 0)
  - B[26] Reserved
  - B[25:20] Negotiated link width  
Set automatically by hardware after Link initialization.
  - B[19:16] Link speed  
The negotiated Link speed: 2.5 Gbps
- LINK\_CONTROL**
- B[15:12] Reserved
  - B[11] Link autonomous bandwidth interrupt enable (reserved for Endpoints)
  - B[10] Link bandwidth management interrupt enable (reserved for Endpoints)
  - B[9] Hardware autonomous width disable (not supported)
  - B[8] Enable clock Power Management  
Hardwired to 0 if Clock Power Management is disabled in the Link Capabilities register.
  - B[7] Extended synch
  - B[6] Common clock configuration
  - B[5] Retrain link (hardwired to 0)
  - B[4] Link disable (hardwired to 0)
  - B[3] Read completion boundary (RCB)
  - B[2] Reserved
  - B[1:0] Active state link PM control

# TW6865

Offset		EP_ERR_CAP_REG0								Default
		[7]	[6]	[5]	[4]	[3]	[2]	[1]	[0]	
0x100	B3	ENHANCE_CAP_HEADER								0x14
	B2									0x01
	B1									0x00
	B0									0x01

## ENHANCE\_CAP\_HEADER

- B[31:20] Next capability offset
- B[19:16] Capability version
- B[15:0] PCI Express extended capability ID  
Default value is 0x1 for Advanced Error Reporting.

Offset		EP_ERR_CAP_REG1								Default
		[7]	[6]	[5]	[4]	[3]	[2]	[1]	[0]	
0x104	B3	UNCORRECTABLE_ERROR_STATUS								0x00
	B2									0x00
	B1									0x00
	B0									0x00

## UNCORRECTABLE\_ERROR\_STATUS

- B[31:21] Reserved
- B[20] Unsupported request error status
- B[19] ECRC error status
- B[18] Malformed TLP status
- B[17] Receiver overflow status
- B[16] Unexpected completion status
- B[15] Completer abort status
- B[14] Completion timeout status
- B[13] Flow control protocol error status
- B[12] Poisoned TLP status
- B[11:6] Reserved
- B[5] Surprise down error status (not supported)
- B[4] Data link protocol error status
- B[3:0] Reserved



# TW6865

Offset		EP_ERR_CAP_REG2								Default
		[7]	[6]	[5]	[4]	[3]	[2]	[1]	[0]	
0x108	B3	UNCORRECTABLE_ERROR_MASK								0x00
	B2									0x00
	B1									0x00
	B0									0x00

## UNCORRECTABLE\_ERROR\_MASK

- B[31:21] Reserved
- B[20] Unsupported request error mask
- B[19] ECRC error mask
- B[18] Malformed TLP mask
- B[17] Receiver overflow mask
- B[16] Unexpected completion mask
- B[15] Completer abort mask
- B[14] Completion timeout mask
- B[13] Flow control protocol error mask
- B[12] Poisoned TLP mask
- B[11:6] Reserved
- B[5] Surprise down error mask (not supported)
- B[4] Data link protocol error mask
- B[3:0] Reserved

Offset		EP_ERR_CAP_REG3								Default
		[7]	[6]	[5]	[4]	[3]	[2]	[1]	[0]	
0x10C	B3	UNCORRECTABLE_ERROR_SEVERITY								0x00
	B2									0x06
	B1									0x20
	B0									0x30

## UNCORRECTABLE\_ERROR\_SEVERITY

- B[31:21] Reserved
- B[20] Unsupported request error severity
- B[19] ECRC error severity
- B[18] Malformed TLP severity
- B[17] Receiver overflow severity
- B[16] Unexpected completion severity
- B[15] Completer abort severity
- B[14] Completion timeout severity
- B[13] Flow control protocol error severity
- B[12] Poisoned TLP severity
- B[11:6] Reserved
- B[5] Surprise down error severity (not supported)
- B[4] Data link protocol error severity
- B[3:0] Reserved

# TW6865

Offset		EP_ERR_CAP_REG4								Default
		[7]	[6]	[5]	[4]	[3]	[2]	[1]	[0]	
0x110	B3	CORRECTABLE_ERROR_STATUS								0x00
	B2									0x00
	B1									0x00
	B0									0x00

### CORRECTABLE\_ERROR\_STATUS

- B[31:14] Reserved
- B[13] Advisory non-fatal error status
- B[12] Reply timer timeout status
- B[11:9] Reserved
- B[8] REPLAY\_NUM rollover status
- B[7] Bad DLLP status
- B[6] Bad TLP status
- B[5] Reserved
- B[4:0] Receiver error status

Offset		EP_ERR_CAP_REG5								Default
		[7]	[6]	[5]	[4]	[3]	[2]	[1]	[0]	
0x114	B3	CORRECTABLE_ERROR_MASK								0x00
	B2									0x00
	B1									0x20
	B0									0x00

### CORRECTABLE\_ERROR\_MASK

- B[31:14] Reserved
- B[13] Advisory non-fatal error mask
- B[12] Reply timer timeout mask
- B[11:9] Reserved
- B[8] REPLAY\_NUM rollover mask
- B[7] Bad DLLP mask
- B[6] Bad TLP mask
- B[5] Reserved
- B[4:0] Receiver error mask

Offset		EP_ERR_CAP_REG6								Default
		[7]	[6]	[5]	[4]	[3]	[2]	[1]	[0]	
0x118	B3	ADVANCE_ERROR_CAP_CONTROL								0x00
	B2									0x00
	B1									0x00
	B0									0xA0

### ADVANCE\_ERROR\_CAP\_CONTROL

- B[31:9] Reserved
- B[8] ECRC check enable
- B[7] ECRC check capable
- B[6] ECRC generation enable
- B[5] ECRC generation capability
- B[4:0] First error pointer

# TW6865

Offset		EP_ERR_CAP_REG7~ EP_ERR_CAP_REGA								Default
		[7]	[6]	[5]	[4]	[3]	[2]	[1]	[0]	
0x11C	B3	HEADER_LOG_1ST_DW								0x00
	B2									0x00
	B1									0x00
	B0									0x00
0x120	B3	HEADER_LOG_2RD_DW								0x00
	B2									0x00
	B1									0x00
	B0									0x00
0x124	B3	HEADER_LOG_3RD_DW								0x00
	B2									0x00
	B1									0x00
	B0									0x00
0x128	B3	HEADER_LOG_4TH_DW								0x00
	B2									0x00
	B1									0x00
	B0									0x00

These 4 header registers collect the header for the TLP corresponding to a detected error.

## Parametric Information

### Absolute Maximum Ratings

Parameter	Symbol	Min	Typ	Max	Units
VDDA (Measured to VSSA)	VDDA <sub>VM</sub>	-0.5		4.5	V
VDDV (Measured to VSSV)	VDDV <sub>AM</sub>	-0.5		4.5	V
VDD12 (Measured to VSS12)	VDD12 <sub>M</sub>	-0.5		2.3	V
VDD33 (Measured to VSS33)	VDD33 <sub>M</sub>	-0.5		4.5	V

**CAUTION:** Do not operate at or near the maximum ratings listed for extended periods of time. Exposure to such conditions may adversely impact product reliability and result in failures not covered by warranty.

### Recommended Operating Conditions

PARAMETER	SYMBOL	MIN	TYP	MAX	UNITS
VDDA (Measured to VSSA)	VDDA <sub>VM</sub>	3.0	3.3	3.6	V
VDDV (Measured to VSSV)	VDDV <sub>AM</sub>	3.0	3.3	3.6	V
VDD12 (Measured to VSS12)	VDD12 <sub>M</sub>	1.08	1.2	1.32	V
VDD33 (Measured to VSS33)	VDD33 <sub>M</sub>	3.0	3.3	3.6	V

### DC Electrical Parameters

PARAMETER	SYMBOL	MIN (NOTE 1)	TYP	MAX (NOTE 1)	UNITS
<b>Digital Inputs</b>					
Input High Voltage (TTL)	V <sub>IH</sub>	2.0		3.6	V
Input Low Voltage (TTL)	V <sub>IL</sub>	-0.3		0.8	V
Input Leakage Current (@V <sub>I</sub> = 2.5V or 0V)	I <sub>L</sub>			±10	µA
Input Capacitance	C <sub>IN</sub>		6		pF
<b>Digital Outputs</b>					
Output High Voltage	V <sub>OH</sub>	2.4			V
Output Low Voltage	V <sub>OL</sub>			0.4	V
High Level Output Current (@V <sub>OH</sub> = 2.4V)	I <sub>OH</sub>	9.3	18.2	29.2	mA
Low Level Output Current (@V <sub>OL</sub> = 0.4V)	I <sub>OL</sub>	7.4	11.8	16.5	mA
Tri-state Output Leakage Current (@V <sub>O</sub> = 2.5V or 0V)	I <sub>OZ</sub>			±10	µA
Output Capacitance	C <sub>O</sub>		6		pF
Analog Pin Input Capacitance	C <sub>A</sub>		6		pF

NOTE :

- Parameters with MIN and/or MAX limits are tested at +25°C, unless otherwise specified. Temperature limits established by characterization and are not production tested.

## Supply Current and Power Dissipation

PARAMETER	SYMBOL	MIN	TYP	MAX	UNITS
Analog Video Supply Current (VDDV, 3.3V)	I <sub>DDV</sub>		110		mA
Analog Audio Supply Current (VDDA, 3.3V)	I <sub>DDA</sub>		37		mA
Digital Internal Supply Current (VDD12, 1.2V)	I <sub>DDI</sub>		190		mA
Digital I/O Supply Current (VDDV, 3.3V)	I <sub>DDS</sub>		4		mA
PCIe Core Current (VP, 1.2V)	I <sub>VP</sub>		21		mA
PCIe IO Current (VPH, 3.3V)	I <sub>VPH</sub>		21		mA
Ambient Operating Temperature		0		+70	°C
Ambient Operating Temperature (H version only)		-40		+85	°C
Total Power Dissipation	P		820.7		mW

## Video Decoder Parameter 1

PARAMETER	SYMBOL	MIN (NOTE 1)	TYP	MAX (NOTE 1)	UNITS
<b>ADCS</b>					
ADC Resolution	ADCR		10		Bits
ADC Integral Non-linearity	AINL		±1		LSB
ADC Differential Non-Linearity	ADNL		±1		LSB
ADC Clock Rate	f <sub>ADC</sub>	24	27	30	MHz
Video Bandwidth (-3db)	BW		10		MHz
<b>HORIZONTAL PLL</b>					
Line Frequency (50Hz)	f <sub>LN</sub>		15.625		kHz
Line Frequency (60Hz)	f <sub>LN</sub>		15.734		kHz
Static Deviation	Δf <sub>H</sub>			6.2	%
<b>SUBCARRIER PLL</b>					
Subcarrier Frequency (NTSC-M)	f <sub>sc</sub>		3579545		Hz
Subcarrier Frequency (PAL-BDGI)	f <sub>sc</sub>		4433619		Hz
Subcarrier Frequency (PAL-M)	f <sub>sc</sub>		3575612		Hz
Subcarrier Frequency (PAL-N)	f <sub>sc</sub>		3582056		Hz
Lock In Range	Δf <sub>H</sub>				Hz
<b>OSCILLATOR INPUT</b>					
Nominal Frequency			27		MHz
Deviation				±50	ppm
Duty cycle				55	%

NOTE :

- Parameters with MIN and/or MAX limits are tested at +25 °C, unless otherwise specified. Temperature limits established by characterization and are not production tested.

**Video Decoder Parameter 2**

PARAMETER	SYMBOL	MIN (NOTE 1)	TYP	MAX (NOTE 1)	UNITS
<b>LOCK SPECIFICATION</b>					
Sync Amplitude Range		1		200	%
Color Burst Range		5		200	%
Horizontal Lock Range		-5		5	%
Vertical Lock Range		45		65	Hz
Fsc Lock Range			±450		Hz
Color Burst Position Range			±2.2		µs
Color Burst Width Range		1			cycle
<b>VIDEO BANDWIDTH</b>					
B/W			6		MHz
<b>NOISE SPECIFICATION</b>					
SNR (Luma Flat Field)			57		dB
<b>NONLINEAR SPECIFICATION</b>					
Y Nonlinearity			0.5	0.7	%
Differential Phase	DP		0.4	0.6	Degree
Differential Gain	DG		0.6	0.8	%
<b>CHROMA SPECIFICATION</b>					
Hue Accuracy			1		Degree
Chroma ACC Range				400	%
Chroma Amplitude Error			1		%
Chroma Phase Error			0.3		%
Chroma Luma Intermodulation			0.2		%
<b>K-FACTOR</b>					
K2T			0.5		%
Kpulse/bar			0.5		%

**NOTE :**

- Parameters with MIN and/or MAX limits are tested at +25°C, unless otherwise specified. Temperature limits established by characterization and are not production tested.

**Analog Audio Parameters**

PARAMETER	SYMBOL	MIN (NOTE 3)	TYP	MAX (NOTE 3)	UNITS
<b>ANALOG AUDIO INPUT CHARACTERISTICS</b>					
AIN1-4 Input Impedance	RINX	10			kΩ
Interchannel Gain Mismatch			0.2		dB
Input Voltage Range				2	Vpp
Full Scale Input Voltage (Note 1)	V <sub>FULL</sub>		1		Vpp
Interchannel Isolation (Note 2)			90		dB

**NOTES:**

1. Tested at input gain of 0 dB, Fin = 1kHz.
2. Tested at input gain of 0 dB, Fs = 8 kHz and 16kHz.
3. Parameters with MIN and/or MAX limits are tested at +25 °C, unless otherwise specified. Temperature limits established by characterization and are not production tested.

Audio Decimation Filter Response

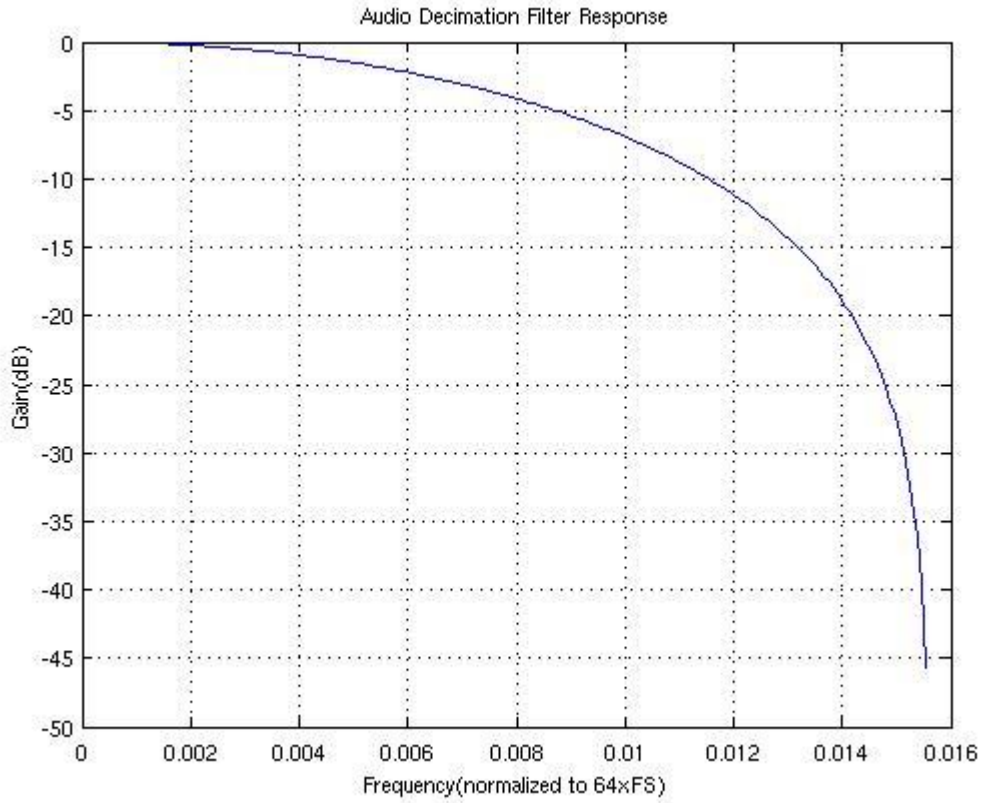
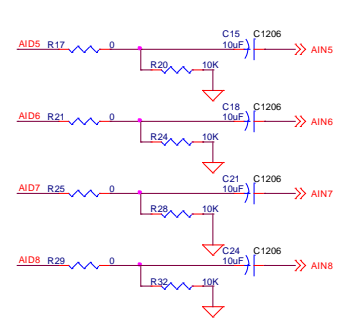
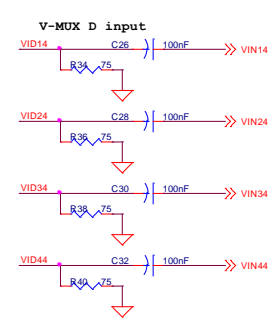
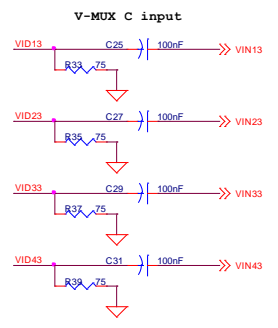
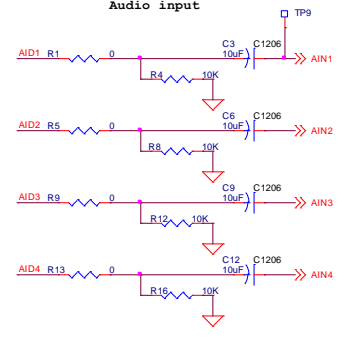
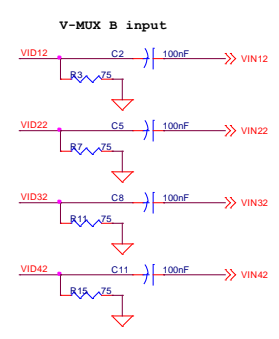
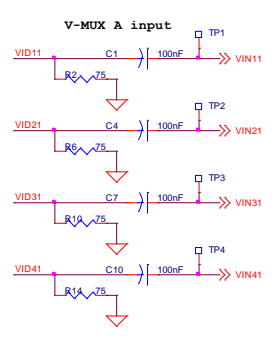
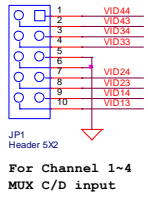
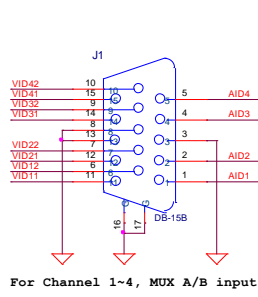
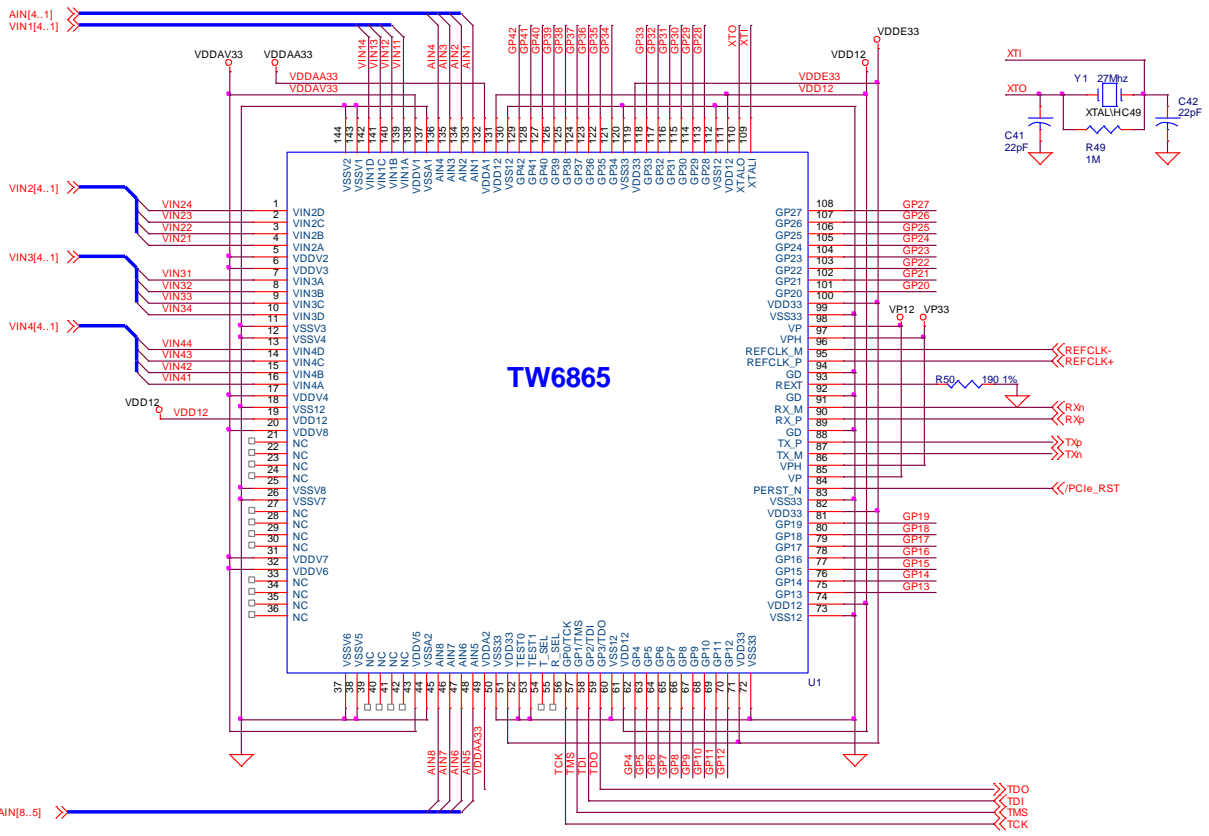

FIGURE 9. (\*) 0.016 LINE = 0.016X64XFS



# Application Schematic



# Package Outline Drawing

Q144.20x20C

144 LEAD THIN QUAD FLATPACK PACKAGE (TQFP)

Rev 0, 2/12

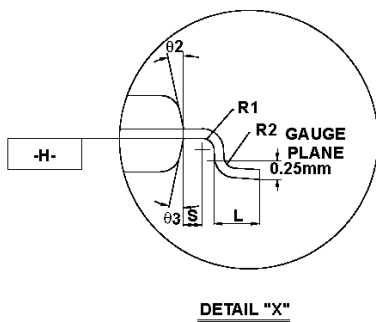
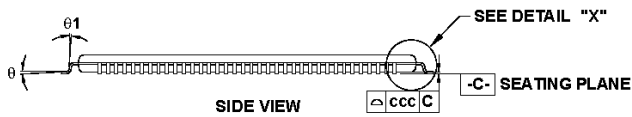
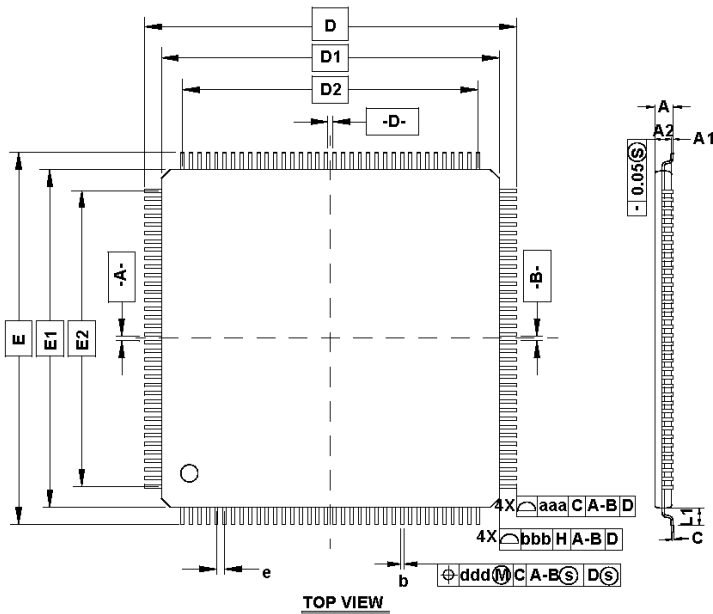

SYMBOL	MILLIMETERS			MILLIMETERS		
	MIN	NOM	MAX	MIN	NOM	MAX
A	1.00	1.10	1.20	0.039	0.043	0.047
A1	0.05	0.10	0.15	0.002	0.004	0.006
A2	0.95	1.00	1.05	0.037	0.039	0.041
D	22.00 BSC			0.866 BSC		
D1	20.00 BSC			0.787 BSC		
E	22.00 BSC			0.866 BSC		
E1	20.00 BSC			0.787 BSC		
R2	0.08	-	0.20	0.003	-	0.008
R1	0.08	-	-	0.003	-	-
$\theta$	0°	3.5°	7°	0°	3.5°	7°
$\theta 1$	0°	-	-	0°	-	-
$\theta 2$	11°	12°	13°	11°	12°	13°
$\theta 3$	11°	12°	13°	11°	12°	13°
c	0.09	-	0.20	0.004	-	0.008
L	0.45	0.60	0.75	0.018	0.024	0.030
L1	1.00 REF			0.039 REF		
S	0.20	-	-	0.008	-	-

SYMBOL	144L					
	MILLIMETERS			MILLIMETERS		
	MIN	NOM	MAX	MIN	NOM	MAX
b	0.17	0.20	0.27	0.007	0.008	0.011
e	0.50 BSC			0.020 BSC		
D2	17.50			0.689		
E2	17.50			0.689		
TOLERANCES OF FORM AND POSITION						
aaa	0.20			0.008		
bbb	0.20			0.008		
ccc	0.08			0.003		
ddd	0.08			0.003		

**NOTES:**

- Dimensions D1 and E1 do not include mold protrusion. Allowable protrusion is 0.25mm per side. D1 and E1 are maximum plastic body size dimensions including mold mismatch.
- Dimension b does not include dambar protrusion. Allowable dambar protrusion shall not cause the lead width to exceed the maximum b dimension by more than 0.08mm. Dambar cannot be located on the lower radius or the foot. Minimum space between protrusion and an adjacent lead is 0.07mm for 0.4mm and 0.5mm pitch packages.
- Control dimensions are in millimeters.

# TW6865

## Revision History

TABLE 3 DATASHEET REVISION HISTORY

REVISION	DATE	DESCRIPTION
FN8304.0	April 12, 2012	Initial release

---

All Intersil U.S. products are manufactured, assembled and tested utilizing ISO9001 quality systems.

Intersil Corporation's quality certifications can be viewed at [www.intersil.com/design/quality](http://www.intersil.com/design/quality).

Intersil products are sold by description only. Intersil Corporation reserves the right to make changes in circuit design, software and/or specifications at any time without notice. Accordingly, the reader is cautioned to verify that data sheets are current before placing orders. Information furnished by Intersil is believed to be accurate and reliable. However, no responsibility is assumed by Intersil or its subsidiaries for its use; nor for any infringements of patents or other rights of third parties which may result from its use. No license is granted by implication or otherwise under any patent or patent rights of Intersil or its subsidiaries.

---

For information regarding Intersil Corporation and its products, see [www.intersil.com](http://www.intersil.com)

# Mouser Electronics

Authorized Distributor

Click to View Pricing, Inventory, Delivery & Lifecycle Information:

[Intersil:](#)

[TW6865-TA1-CR](#)