

Single Digitally Controlled (XDCP™) Potentiometer

The Intersil X9015 is a 32 tap potentiometer that is volatile. The device consists of a string of 31 resistors that can be programmed to connect the R_W/V_W wiper output with any of the nodes between the connecting resistors. The connection point of the wiper is determined by information communicated to the device on the 3-wire port. The 3-wire port changes the tap position by a falling edge on the increment pin. The direction the wiper moves is determined by the state of the up/down pin. The wiper position at power up is Tap #15.

The X9015 can be used in a wide variety of applications that require a digitally controlled variable resistor to set analog values.

Features

- 32 taps
- Three-wire up/down serial interface
- $V_{CC} = 2.7V-5V$
- Operating $I_{CC} = 50\mu A$ max.
- Standby current = $1\mu A$ max.
- $R_{TOTAL} = 10k\Omega, 50k\Omega$
- Packages 8 Ld SOIC, 8 Ld MSOP
- Pb-free plus anneal available (RoHS compliant)

Pinout

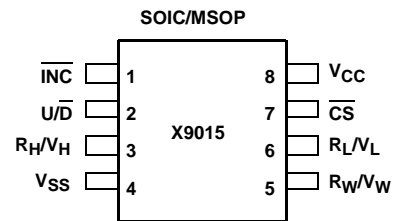

Block Diagram

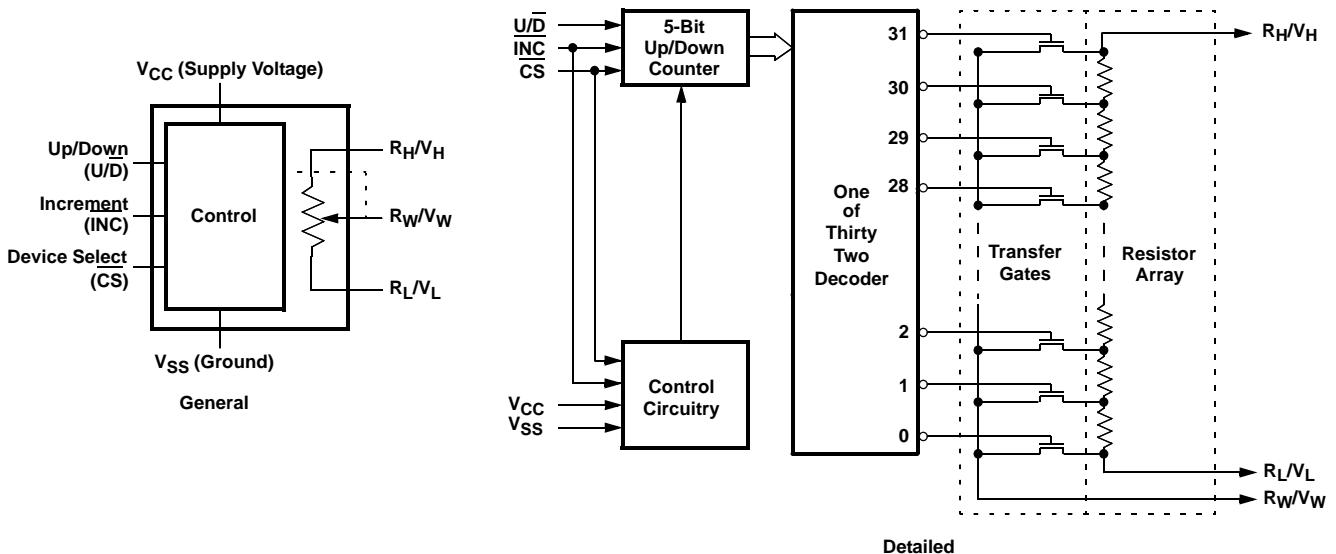

Ordering Information

PART NUMBER	PART MARKING	V _{CC} LIMITS (V)	R _{TOTAL} (kΩ)	TEMPERATURE RANGE (°C)	PACKAGE	PKG. DWG. #		
X9015WS8T1	X9015W	5 ±10%	10	0 to +70	8 Ld SOIC Tape and Reel	M8.15		
X9015WS8ZT1 (Note)	X9015W Z			0 to +70	8 Ld SOIC (Pb-free) Tape and Reel	M8.15		
X9015UM8	ABB		50	50	0 to +70	8 Ld MSOP	M8.118	
X9015UM8Z (Note)	DCF				0 to +70	8 Ld MSOP (Pb-free)	M8.118	
X9015UM8I*	ABD				-40 to +85	8 Ld MSOP	M8.118	
X9015UM8IZ* (Note)	DCD				-40 to +85	8 Ld MSOP (Pb-free)	M8.118	
X9015US8*	X9015U				0 to +70	8 Ld SOIC	M8.15	
X9015US8Z* (Note)	X9015U Z				0 to +70	8 Ld SOIC (Pb-free)	M8.15	
X9015US8I*	X9015U I				-40 to +85	8 Ld SOIC	M8.15	
X9015US8IZ* (Note)	X9015U Z I				-40 to +85	8 Ld SOIC (Pb-free)	M8.15	
X9015WS8-2.7*	X9015W F	2.7-5.5			10	0 to +70	8 Ld SOIC	M8.15
X9015WS8Z-2.7* (Note)	X9015W ZF					0 to +70	8 Ld SOIC (Pb-free)	M8.15
X9015UM8-2.7*	ABC		50	50	0 to +70	8 Ld MSOP	M8.118	
X9015UM8Z-2.7* (Note)	DCF				0 to +70	8 Ld MSOP (Pb-free)	M8.118	
X9015UM8I-2.7*	ABE				-40 to +85	8 Ld MSOP	M8.118	
X9015UM8IZ-2.7* (Note)	DCE				-40 to +85	8 Ld MSOP (Pb-free)	M8.118	
X9015US8-2.7*	X9015U F				0 to +70	8 Ld SOIC	M8.15	
X9015US8Z-2.7* (Note)	X9015U ZF				0 to +70	8 Ld SOIC (Pb-free)	M8.15	
X9015US8I-2.7*	X9015U G				-40 to +85	8 Ld SOIC	M8.15	
X9015US8IZ-2.7* (Note)	X9015U ZG				-40 to +85	8 Ld SOIC (Pb-free)	M8.15	

* Add "T1" suffix for tape and reel.

NOTE: Intersil Pb-free plus anneal products employ special Pb-free material sets; molding compounds/die attach materials and 100% matte tin plate termination finish, which are RoHS compliant and compatible with both SnPb and Pb-free soldering operations. Intersil Pb-free products are MSL classified at Pb-free peak reflow temperatures that meet or exceed the Pb-free requirements of IPC/JEDEC J STD-020.

Pin Descriptions

R_H/V_H and R_L/V_L

The high (R_H/V_H) and low (R_L/V_L) terminals of the X9015 are equivalent to the fixed terminals of a mechanical potentiometer. The minimum voltage is V_{SS} and the maximum is V_{CC} . The terminology of R_L/V_L and R_H/V_H references the relative position of the terminal in relation to wiper movement direction selected by the U/\bar{D} input, and not the voltage potential on the terminal.

R_W/V_W

R_W/V_W is the wiper terminal and is equivalent to the movable terminal of a mechanical potentiometer. The position of the wiper within the array is determined by the control inputs. The wiper terminal series resistance is typically 200Ω at $V_{CC}=5V$. At power up the wiper position is at Tap #15. (V_L/R_L =Tap #0).

Up/Down (U/\bar{D})

The U/\bar{D} input controls the direction of the wiper movement and whether the tap position is incremented or decremented.

Increment (\bar{INC})

The \bar{INC} input is negative-edge triggered. Toggling \bar{INC} will move the wiper and either increment or decrement the counter in the direction indicated by the logic level on the U/\bar{D} input.

Chip Select (\bar{CS})

The device is selected when the \bar{CS} input is LOW. When \bar{CS} is returned HIGH while the \bar{INC} input is also HIGH the X9015 will be placed in the low power standby mode until the device is selected once again.

Pin Names

SYMBOL	DESCRIPTION
R_H/V_H	High terminal
R_W/V_W	Wiper terminal
R_L/V_L	Low terminal
V_{SS}	Ground
V_{CC}	Supply voltage
U/\bar{D}	Up/Down control input
\bar{INC}	Increment control input
\bar{CS}	Chip select control input

Principles Of Operation

There are two sections of the X9015: the input control, counter and decode section; and the resistor array. The input control section operates just like an up/down counter. The output of this counter is decoded to turn on a single electronic switch connecting a point on the resistor array to the wiper output. The resistor array is comprised of 31 individual resistors connected in series.

The wiper, when at either fixed terminal, acts like its mechanical equivalent and does not move beyond the last position. That is, the counter does not wrap around when clocked to either extreme.

The electronic switches on the device operate in a "make before break" mode when the wiper changes tap positions. If the wiper is moved several positions, multiple taps are connected to the wiper for t_{1W} (INC to V_W change). The R_{TOTAL} value for the device can temporarily be reduced by a significant amount if the wiper is moved several positions.

When the device is powered-down, the wiper position is lost. When power is restored, the wiper is set to Tap #15.





Instructions and Programming

The \bar{INC} , U/\bar{D} and \bar{CS} inputs control the movement of the wiper along the resistor array. With \bar{CS} set LOW the device is selected and enabled to respond to the U/\bar{D} and \bar{INC} inputs. HIGH to LOW transitions on \bar{INC} will increment or decrement (depending on the state of the U/\bar{D} input) a five bit counter. The output of this counter is decoded to select one of thirty two wiper positions along the resistive array.

The system may select the X9015, move the wiper and deselect the device. The new wiper position will be maintained until changed by the system or until a power-up/down cycle.

The state of U/\bar{D} may be changed while \bar{CS} remains LOW. This allows the host system to enable the device and then move the wiper up and down until the proper trim is attained.

Mode Selection

\bar{CS}	\bar{INC}	U/\bar{D}	MODE
L		H	Wiper up
L		L	Wiper down
	H	X	Standby mode
H	X	X	Standby mode
L	L	X	Normal mode
	L	H	Wiper Up (not recommended)
	L	L	Wiper Down (not recommended)

Absolute Maximum Ratings

Temperature under bias -65°C to +135°C
 Storage temperature -65°C to +150°C
 Voltage on CS, INC, U/D, V_H, V_L and V_{CC} with respect to V_{SS} -1V to +7V
 $\Delta V = |V_H - V_L|$ 5V
 Lead temperature (soldering 10s) +300°C
 I_W (10s) ±7.5mA

Operating Conditions

Temperature Range
 Commercial 0°C to +70°C
 Industrial -40°C to +85°C
 Supply Voltage (V_{CC})
 X9015 5V ±10%
 X9015-2.7 2.7V to 5.5V

CAUTION: Stresses above those listed in "Absolute Maximum Ratings" may cause permanent damage to the device. This is a stress only rating and operation of the device at these or any other conditions above those indicated in the operational sections of this specification is not implied.

Potentiometer Specifications Over recommended operating conditions unless otherwise stated

SYMBOL	PARAMETER	TEST CONDITIONS/NOTES	MIN.	TYP.	MAX.	UNIT
R _{TOTAL}	End to End Resistance Variation		-20		+20	%
V _{VH}	V _H /R _H Terminal Voltage		0		V _{CC}	V
V _{VL}	V _L /R _L Terminal Voltage		0		V _{CC}	V
	Power Rating	R _{TOTAL} ≤ 1kΩ			10	mW
R _W	Wiper Resistance	I _W = 1mA, V _{CC} = 5V		200	400	Ω
R _W	Wiper Resistance	I _W = 1mA, V _{CC} = 2.7V		400	1000	Ω
I _W	Wiper Current		-3.75		3.75	mA
	Noise	Ref: 1kHz		-120		dBV
	Resolution			3		%
	Absolute Linearity (Note 1)	V _{w(n)(actual)} - V _{w(n)(expected)}	-1		+1	MI (Note 3)
	Relative Linearity (Note 2)	V _{w(n+1)} - [V _{w(n)} + MI]	-0.2		+0.2	MI (Note 3)
	R _{TOTAL} Temperature Coefficient			±300		ppm/°C
	Ratiometric Temperature Coefficient				±20	ppm/°C
C _H /C _L /C _W	Potentiometer Capacitances	See circuit #3		10/10/25		pF

Power Up and Down Requirements

The are no restrictions on the power-up or power-down conditions of V_{CC} and the voltages applied to the potentiometer pins provided that V_{CC} is always more positive than or equal to V_H, V_L, and V_W, i.e., V_{CC} ≥ V_H, V_L, V_W. The V_{CC} ramp rate spec is always in effect.

NOTES:

1. Absolute Linearity is utilized to determine actual wiper voltage versus expected voltage = (V_{w(n)(actual)} - V_{w(n)(expected)}) = ±1 MI Maximum.
2. Relative Linearity is a measure of the error in step size between taps = V_{w(n+1)} - [V_{w(n)} + MI] = ±0.2 MI.
3. 1 MI = Minimum Increment = R_{TO7}/31.
4. Typical values are for T_A = +25°C and nominal supply voltage.
5. This parameter is periodically sampled and not 100% tested.

D.C. Operating Specifications *Over recommended operating conditions unless otherwise specified*

SYMBOL	PARAMETER	TEST CONDITIONS	MIN.	TYP. (Note 4)	MAX.	UNITS
I _{CC1}	V _{CC} active current (increment)	$\overline{CS} = V_{IL}$, $U/\overline{D} = V_{IL}$ or V_{IH} and $INC = 0.4V$ @ max. t_{CYC}			50	μA
I _{CC2}	V _{CC} active current (Store) (EEPROM Store)	$\overline{CS} = V_{IH}$, $U/\overline{D} = V_{IL}$ or V_{IH} and $INC = V_{IH}$ @ max. t_{WR}			400	μA
I _{SB}	Standby supply current	$\overline{CS} = V_{CC} - 0.3V$, U/\overline{D} and $INC = V_{SS}$ or $V_{CC} - 0.3V$			1	μA
I _{LI}	\overline{CS} , INC , U/\overline{D} input leakage current	$V_{IN} = V_{SS}$ to V_{CC}			±10	μA
V _{IH}	\overline{CS} , INC , U/\overline{D} input HIGH voltage		$V_{CC} \times 0.7$		$V_{CC} + 0.5$	V
V _{IL}	\overline{CS} , INC , U/\overline{D} input LOW voltage		-0.5		$V_{CC} \times 0.1$	V
C _{IN} (Note 5)	\overline{CS} , INC , U/\overline{D} input capacitance	$V_{CC} = 5V$, $V_{IN} = V_{SS}$, $T_A = 25^\circ C$, $f = 1MHz$			10	pF

TEST CIRCUIT #1

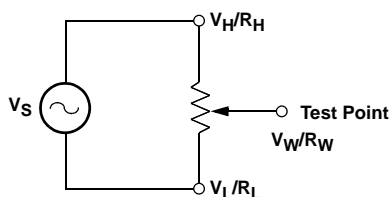

TEST CIRCUIT #2

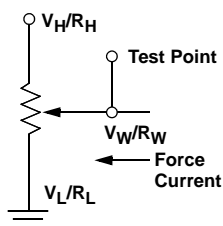

CIRCUIT #3 SPICE MACRO MODEL

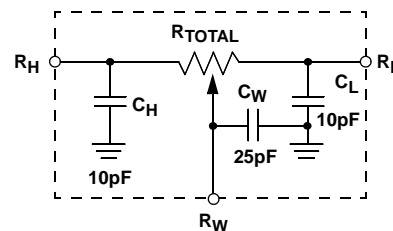

Symbol Table

WAVEFORM	INPUTS	OUTPUTS
	Must be steady	Will be steady
	May change from Low to High	Will change from Low to High
	May change from High to Low	Will change from High to Low
	Don't Care: Changes Allowed	Changing: State Not Known
	N/A	Center Line is High Impedance

A.C. Conditions of Test

Input pulse levels	0V to 3V
Input rise and fall times	10ns
Input reference levels	1.5V

A.C. Operating Specifications *Over recommended operating conditions unless otherwise specified*

SYMBOL	PARAMETER	MIN.	TYP. (Note 6)	MAX.	UNIT
t_{CI}	\overline{CS} to \overline{INC} setup	100			ns
t_{ID}	\overline{INC} HIGH to U/\overline{D} change	100			ns
t_{DI}	U/\overline{D} to \overline{INC} setup	2.9			μ s
t_{IL}	\overline{INC} LOW period	1			μ s
t_{IH}	\overline{INC} HIGH period	1			μ s
t_{IC}	\overline{INC} inactive to \overline{CS} inactive	1			μ s
t_{CPH}	\overline{CS} deselect time (NO STORE)	100			ns
t_{CPH}	\overline{CS} deselect time (STORE)	10			ms
t_{IW}	\overline{INC} to V_w change		1	5	μ s
t_{CYC}	\overline{INC} cycle time	4			μ s
t_R, t_F (Note 7)	\overline{INC} input rise and fall time			500	μ s
t_{PU} (Note 7)	Power up to wiper stable			5	μ s
$t_R V_{CC}$ (Note 7)	V_{CC} power-up rate	0.2		50	V/ms
t_{WR}	Store cycle		5	10	ms

A.C. Timing

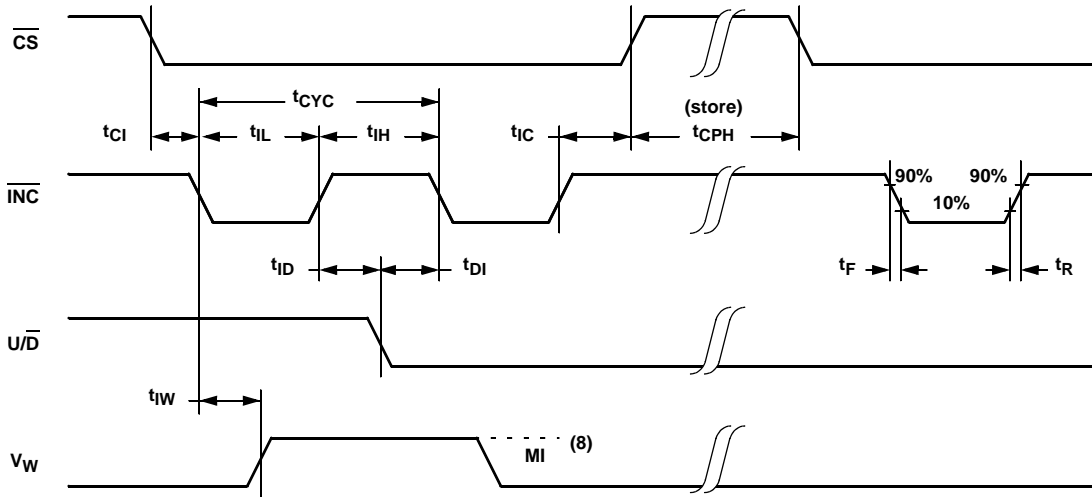

NOTES:

- Typical values are for $T_A = +25^\circ\text{C}$ and nominal supply voltage.
- This parameter is periodically sampled and not 100% tested.
- MI in the A.C. timing diagram refers to the minimum incremental change in the V_w output due to a change in the wiper position.

Performance Characteristics (Typical)

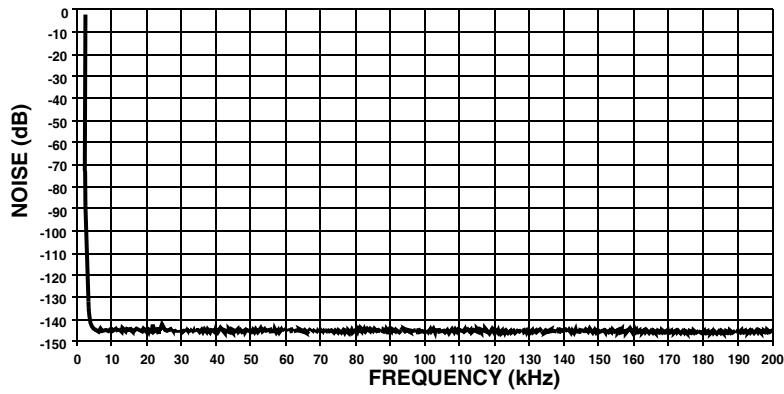

FIGURE 1. TYPICAL NOISE

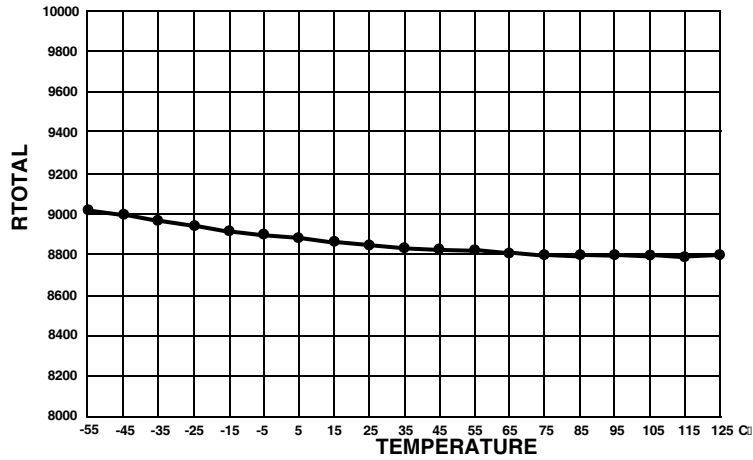

FIGURE 2. TYPICAL RTOTAL VS. TEMPERATURE

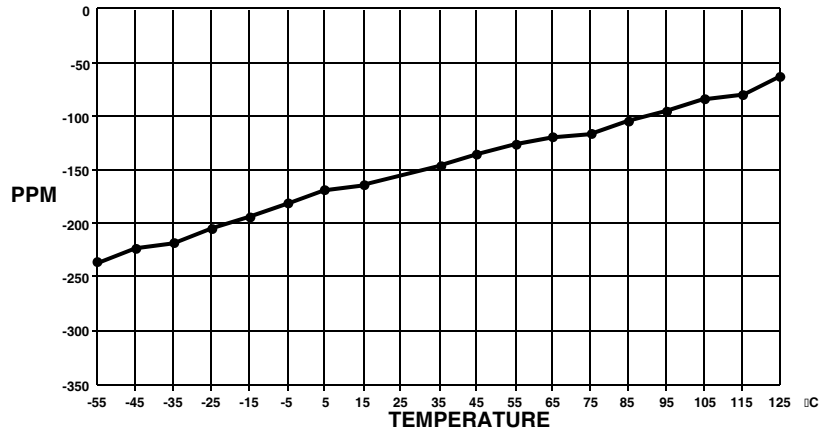

FIGURE 3. TYPICAL TOTAL RESISTANCE TEMPERATURE COEFFICIENT

Performance Characteristics (Typical) (Continued)

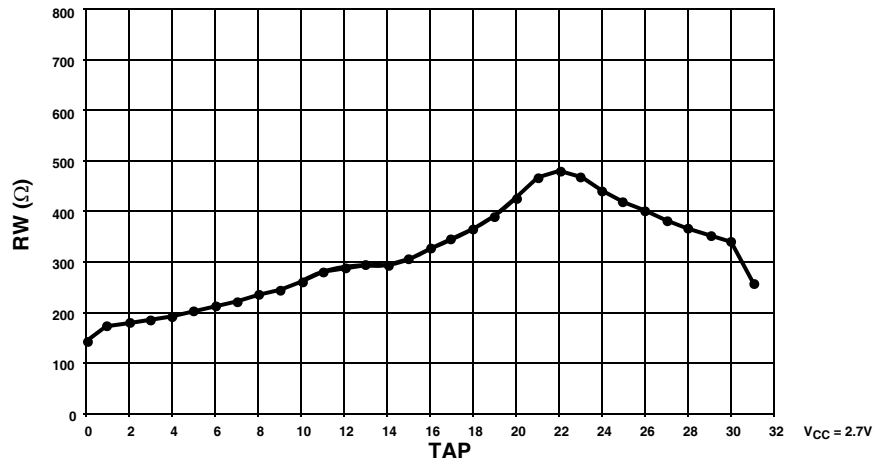

FIGURE 4. TYPICAL WIPER RESISTANCE

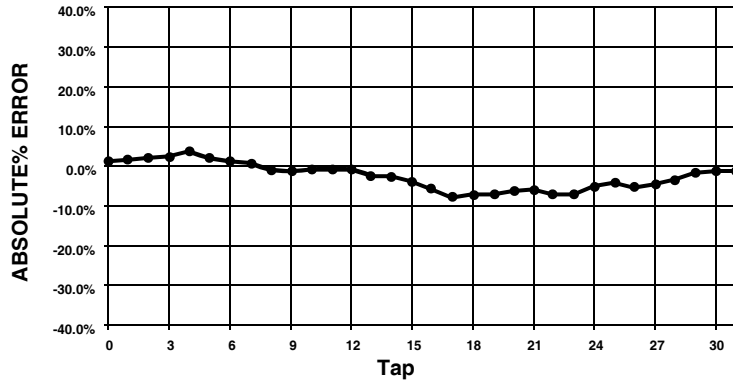

FIGURE 5. TYPICAL ABSOLUTE% ERROR PER TAP POSITION

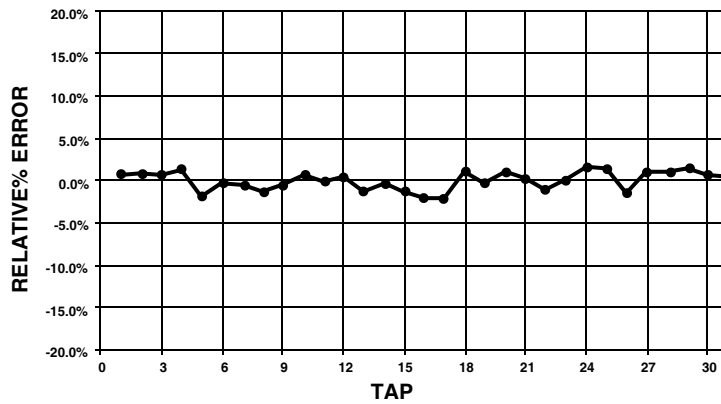
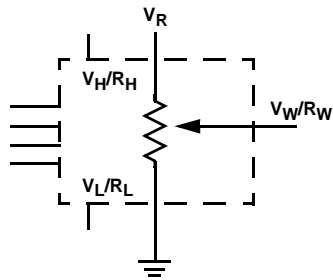

FIGURE 6. TYPICAL RELATIVE% ERROR PER TAP POSITION

Applications Information

Electronic digitally controlled potentiometers provide two powerful application advantages: (1) the variability and reliability of a solid-state potentiometer, and (2) the flexibility of computer-based digital controls.

Basic Configurations of Electronic Potentiometers



THREE-TERMINAL POTENTIOMETER;
VARIABLE VOLTAGE DIVIDER

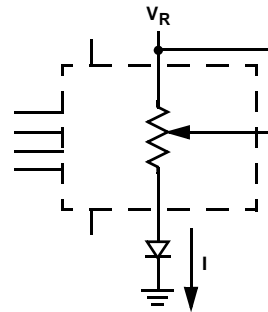

TWO-TERMINAL VARIABLE RESISTOR;
VARIABLE CURRENT

Basic Circuits

Buffered Reference Voltage

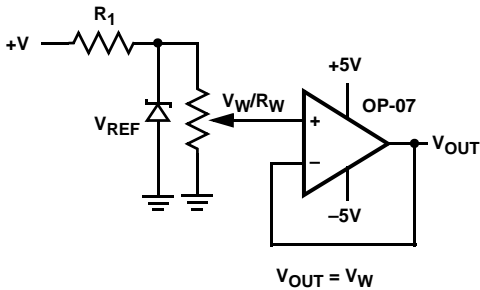

$$V_{OUT} = V_W$$

Cascading Techniques

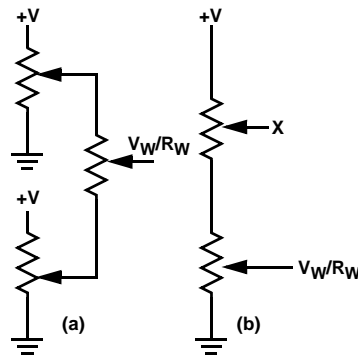

Noninverting Amplifier

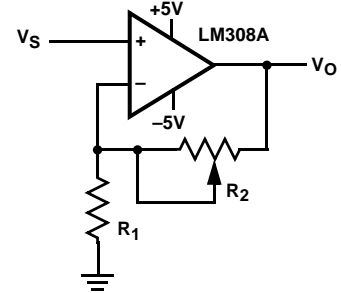

$$V_O = (1 + R_2/R_1)V_S$$

VOLTAGE REGULATOR

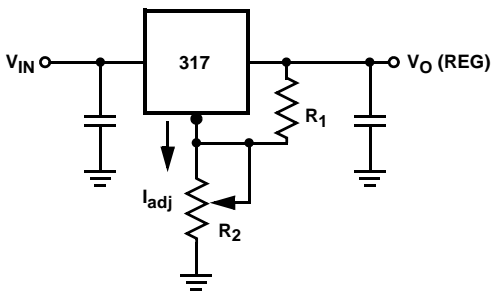

$$V_O (REG) = 1.25V (1 + R_2/R_1) + I_{adj} R_2$$

OFFSET VOLTAGE ADJUSTMENT

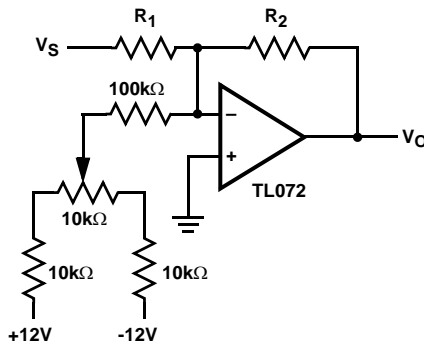

COMPARATOR WITH HYSTERESIS

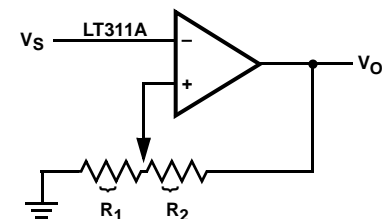

$$V_{UL} = \{R_1/(R_1 + R_2)\} V_O(\max)$$

$$V_{LL} = \{R_1/(R_1 + R_2)\} V_O(\min)$$

(FOR ADDITIONAL CIRCUITS, SEE AN115.)

Small Outline Plastic Packages (SOIC)

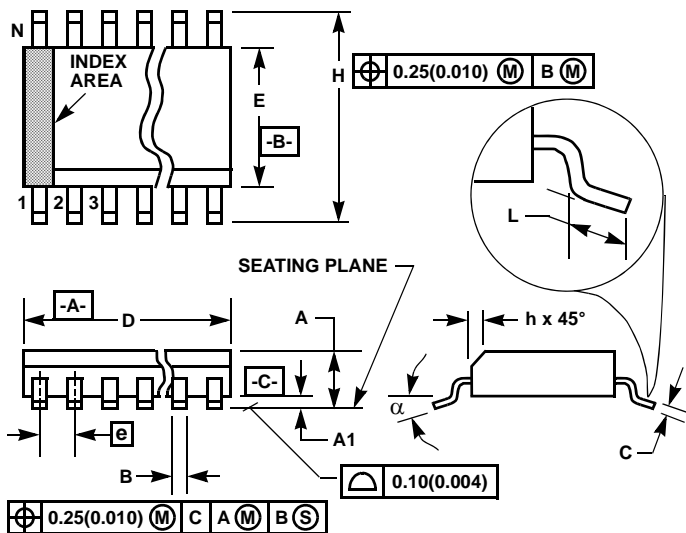

M8.15 (JEDEC MS-012-AA ISSUE C)
8 LEAD NARROW BODY SMALL OUTLINE PLASTIC PACKAGE

SYMBOL	INCHES		MILLIMETERS		NOTES
	MIN	MAX	MIN	MAX	
A	0.0532	0.0688	1.35	1.75	-
A1	0.0040	0.0098	0.10	0.25	-
B	0.013	0.020	0.33	0.51	9
C	0.0075	0.0098	0.19	0.25	-
D	0.1890	0.1968	4.80	5.00	3
E	0.1497	0.1574	3.80	4.00	4
e	0.050 BSC		1.27 BSC		-
H	0.2284	0.2440	5.80	6.20	-
h	0.0099	0.0196	0.25	0.50	5
L	0.016	0.050	0.40	1.27	6
N	8		8		7
α	0°	8°	0°	8°	-

NOTES:

1. Symbols are defined in the "MO Series Symbol List" in Section 2.2 of Publication Number 95.
2. Dimensioning and tolerancing per ANSI Y14.5M-1982.
3. Dimension "D" does not include mold flash, protrusions or gate burrs. Mold flash, protrusion and gate burrs shall not exceed 0.15mm (0.006 inch) per side.
4. Dimension "E" does not include interlead flash or protrusions. Interlead flash and protrusions shall not exceed 0.25mm (0.010 inch) per side.
5. The chamfer on the body is optional. If it is not present, a visual index feature must be located within the crosshatched area.
6. "L" is the length of terminal for soldering to a substrate.
7. "N" is the number of terminal positions.
8. Terminal numbers are shown for reference only.
9. The lead width "B", as measured 0.36mm (0.014 inch) or greater above the seating plane, shall not exceed a maximum value of 0.61mm (0.024 inch).
10. Controlling dimension: MILLIMETER. Converted inch dimensions are not necessarily exact.

Rev. 1 6/05

Mini Small Outline Plastic Packages (MSOP)

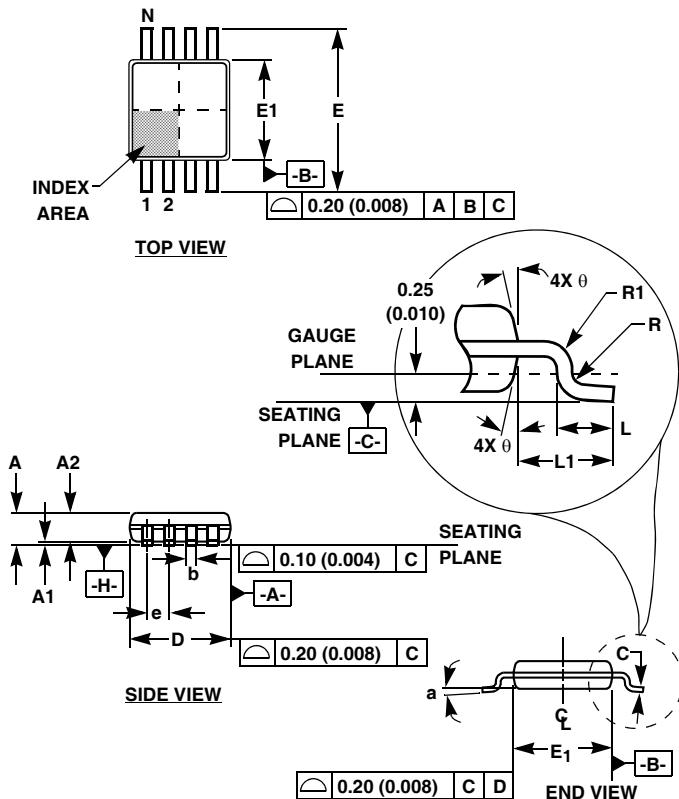

M8.118 (JEDEC MO-187AA)
8 LEAD MINI SMALL OUTLINE PLASTIC PACKAGE

SYMBOL	INCHES		MILLIMETERS		NOTES
	MIN	MAX	MIN	MAX	
A	0.037	0.043	0.94	1.10	-
A1	0.002	0.006	0.05	0.15	-
A2	0.030	0.037	0.75	0.95	-
b	0.010	0.014	0.25	0.36	9
c	0.004	0.008	0.09	0.20	-
D	0.116	0.120	2.95	3.05	3
E1	0.116	0.120	2.95	3.05	4
e	0.026 BSC		0.65 BSC		-
E	0.187	0.199	4.75	5.05	-
L	0.016	0.028	0.40	0.70	6
L1	0.037 REF		0.95 REF		-
N	8		8		7
R	0.003	-	0.07	-	-
R1	0.003	-	0.07	-	-
theta	5°	15°	5°	15°	-
alpha	0°	6°	0°	6°	-

Rev. 2 01/03

NOTES:

1. These package dimensions are within allowable dimensions of JEDEC MO-187BA.
2. Dimensioning and tolerancing per ANSI Y14.5M-1994.
3. Dimension "D" does not include mold flash, protrusions or gate burrs and are measured at Datum Plane. Mold flash, protrusion and gate burrs shall not exceed 0.15mm (0.006 inch) per side.
4. Dimension "E1" does not include interlead flash or protrusions and are measured at Datum Plane. [-H-] Interlead flash and protrusions shall not exceed 0.15mm (0.006 inch) per side.
5. Formed leads shall be planar with respect to one another within 0.10mm (0.004) at seating Plane.
6. "L" is the length of terminal for soldering to a substrate.
7. "N" is the number of terminal positions.
8. Terminal numbers are shown for reference only.
9. Dimension "b" does not include dambar protrusion. Allowable dambar protrusion shall be 0.08mm (0.003 inch) total in excess of "b" dimension at maximum material condition. Minimum space between protrusion and adjacent lead is 0.07mm (0.0027 inch).
10. Datums [-A-] and [-B-] to be determined at Datum plane [-H-].
11. Controlling dimension: MILLIMETER. Converted inch dimensions are for reference only.

All Intersil U.S. products are manufactured, assembled and tested utilizing ISO9000 quality systems.
Intersil Corporation's quality certifications can be viewed at www.intersil.com/design/quality

Intersil products are sold by description only. Intersil Corporation reserves the right to make changes in circuit design, software and/or specifications at any time without notice. Accordingly, the reader is cautioned to verify that data sheets are current before placing orders. Information furnished by Intersil is believed to be accurate and reliable. However, no responsibility is assumed by Intersil or its subsidiaries for its use; nor for any infringements of patents or other rights of third parties which may result from its use. No license is granted by implication or otherwise under any patent or patent rights of Intersil or its subsidiaries.

For information regarding Intersil Corporation and its products, see www.intersil.com

Mouser Electronics

Authorized Distributor

Click to View Pricing, Inventory, Delivery & Lifecycle Information:

Intersil:

[X9015UM8IZ](#) [X9015UM8IZ-2.7](#) [X9015UM8IZ-2.7T1](#) [X9015UM8IZT1](#) [X9015UM8Z](#) [X9015UM8Z-2.7](#) [X9015UM8Z-2.7T1](#) [X9015UM8ZT1](#) [X9015US8IZ](#) [X9015US8IZ-2.7](#) [X9015US8IZ-2.7T1](#) [X9015US8IZT1](#) [X9015US8Z](#) [X9015US8Z-2.7T1](#) [X9015US8ZT1](#) [X9015WS8Z-2.7](#) [X9015WS8Z-2.7T1](#) [X9015WS8ZT1](#) [X9015US8Z-2.7](#)