



# Intel® Xeon® Processor 5500 Series

Datasheet, Volume 1

---

*June 2011*



INFORMATION IN THIS DOCUMENT IS PROVIDED IN CONNECTION WITH INTEL® PRODUCTS. NO LICENSE, EXPRESS OR IMPLIED, BY ESTOPPEL OR OTHERWISE, TO ANY INTELLECTUAL PROPERTY RIGHTS IS GRANTED BY THIS DOCUMENT. EXCEPT AS PROVIDED IN INTEL'S TERMS AND CONDITIONS OF SALE FOR SUCH PRODUCTS, INTEL ASSUMES NO LIABILITY WHATSOEVER, AND INTEL DISCLAIMS ANY EXPRESS OR IMPLIED WARRANTY, RELATING TO SALE AND/OR USE OF INTEL PRODUCTS INCLUDING LIABILITY OR WARRANTIES RELATING TO FITNESS FOR A PARTICULAR PURPOSE, MERCHANTABILITY, OR INFRINGEMENT OF ANY PATENT, COPYRIGHT OR OTHER INTELLECTUAL PROPERTY RIGHT. Intel products are not intended for use in medical, life saving, or life sustaining applications.

Intel may make changes to specifications and product descriptions at any time, without notice.

Designers must not rely on the absence or characteristics of any features or instructions marked "reserved" or "undefined." Intel reserves these for future definition and shall have no responsibility whatsoever for conflicts or incompatibilities arising from future changes to them.

The Intel® Xeon® Processor 5500 Series may contain design defects or errors known as errata which may cause the product to deviate from published specifications. Current characterized errata are available on request.

Intel processor numbers are not a measure of performance. Processor numbers differentiate features within each processor family, not across different processor families. See [http://www.intel.com/products/processor\\_number](http://www.intel.com/products/processor_number) for details. Over time processor numbers will increment based on changes in clock, speed, cache, FSB, or other features, and increments are not intended to represent proportional or quantitative increases in any particular feature. Current roadmap processor number progression is not necessarily representative of future roadmaps. See [www.intel.com/products/processor\\_number](http://www.intel.com/products/processor_number) for details.

Hyper-Threading Technology requires a computer system with a processor supporting HT Technology and an HT Technology-enabled chipset, BIOS and operating system. Performance will vary depending on the specific hardware and software you use. For more information including details on which processors support HT Technology, see [http://www.intel.com/products/ht/hyperthreading\\_more.htm](http://www.intel.com/products/ht/hyperthreading_more.htm)

Enabling Execute Disable Bit functionality requires a PC with a processor with Execute Disable Bit capability and a supporting operating system. Check with your PC manufacturer on whether your system delivers Execute Disable Bit functionality.

64-bit computing on Intel architecture requires a computer system with a processor, chipset, BIOS, operating system, device drivers and applications enabled for Intel® 64 architecture. Performance will vary depending on your hardware and software configurations. Consult with your system vendor for more information.

Intel® Virtualization Technology requires a computer system with an enabled Intel® processor, BIOS, virtual machine monitor (VMM) and, for some uses, certain computer system software enabled for it. Functionality, performance or other benefits will vary depending on hardware and software configurations and may require a BIOS update. Software applications may not be compatible with all operating systems. Please check with your application vendor.

Intel® Turbo Boost Technology requires a PC with a processor with Intel Turbo Boost Technology capability. Intel Turbo Boost Technology performance varies depending on hardware, software and overall system configuration. Check with your PC manufacturer on whether your system delivers Intel Turbo Boost Technology. For more information, see [www.intel.com](http://www.intel.com).

Enhanced Intel SpeedStep® Technology. See the <http://processorfinder.intel.com> or contact your Intel representative for more information.

Contact your local Intel sales office or your distributor to obtain the latest specifications and before placing your product order.

Intel, Xeon, Enhanced Intel SpeedStep Technology, and the Intel logo are trademarks of Intel Corporation in the United States and other countries.

\*Other brands and names are the property of their respective owners.

Copyright © 2009-2011, Intel Corporation.



# Contents

---

<b>1</b>	<b>Introduction</b>	9
1.1	Terminology	10
1.2	References	12
1.3	Statement of Volatility	12
<b>2</b>	<b>Intel® Xeon® Processors 5500 Series Electrical Specifications</b>	13
2.1	Processor Signaling	13
2.1.1	Intel® QuickPath Interconnect	13
2.1.2	DDR3 Signal Groups	13
2.1.3	Platform Environmental Control Interface (PECI)	14
2.1.4	Processor Sideband Signals	14
2.1.5	System Reference Clock	14
2.1.6	Test Access Port (TAP) Signals	15
2.1.7	Power / Other Signals	15
2.1.8	Reserved or Unused Signals	23
2.2	Signal Group Summary	23
2.3	Mixing Processors	25
2.4	Flexible Motherboard Guidelines (FMB)	26
2.5	Absolute Maximum and Minimum Ratings	26
2.6	Processor DC Specifications	27
2.6.1	VCC Overshoot Specifications	31
2.6.2	Die Voltage Validation	32
<b>3</b>	<b>Package Mechanical Specifications</b>	43
3.1	Package Mechanical Specifications	43
3.1.1	Package Mechanical Drawing	44
3.1.2	Processor Component Keep-Out Zones	47
3.1.3	Package Loading Specifications	47
3.1.4	Package Handling Guidelines	47
3.1.5	Package Insertion Specifications	47
3.1.6	Processor Mass Specification	48
3.1.7	Processor Materials	48
3.1.8	Processor Markings	48
3.1.9	Processor Land Coordinates	48
<b>4</b>	<b>Land Listing</b>	49
4.1	Intel® Xeon® Processors 5500 Series Pin Assignments	49
4.1.1	Land Listing by Land Name	49
4.1.2	Land Listing by Land Number	67
<b>5</b>	<b>Signal Definitions</b>	85
5.1	Signal Definitions	85
<b>6</b>	<b>Thermal Specifications</b>	89
6.1	Package Thermal Specifications	89
6.1.1	Thermal Specifications	89
6.1.2	Thermal Metrology	102
6.2	Processor Thermal Features	103
6.2.1	Processor Temperature	103
6.2.2	Adaptive Thermal Monitor	103
6.2.3	On-Demand Mode	105
6.2.4	PROCHOT# Signal	105
6.2.5	THERMTRIP# Signal	106
6.3	Platform Environment Control Interface (PECI)	106
6.3.1	PECI Client Capabilities	107



6.3.2	Client Command Suite .....	108
6.3.3	Multi-Domain Commands .....	124
6.3.4	Client Responses .....	124
6.3.5	Originator Responses .....	125
6.3.6	Temperature Data .....	126
6.3.7	Client Management .....	127
<b>7</b>	<b>Features</b> .....	<b>131</b>
7.1	Power-On Configuration (POC).....	131
7.2	Clock Control and Low Power States .....	132
7.2.1	Thread and Core Power State Descriptions .....	133
7.2.2	Package Power State Descriptions.....	134
7.2.3	Intel Xeon Processor 5500 Series C-State Power Specifications .....	135
7.3	Sleep States .....	136
7.4	Intel® Turbo Boost Technology .....	136
7.5	Enhanced Intel SpeedStep® Technology .....	136
<b>8</b>	<b>Boxed Processor Specifications</b> .....	<b>137</b>
8.1	Introduction .....	137
8.1.1	Available Boxed Thermal Solution Configurations .....	137
8.1.2	An Intel “Combo” Boxed Passive / Active Combination Heat Sink Solution.....	137
8.1.3	Intel Boxed “Active” Heat Sink Solution .....	138
8.1.4	Intel Boxed 25.5mm Tall Passive Heat Sink Solution.....	139
8.2	Mechanical Specifications .....	140
8.2.1	Boxed Processor Heat Sink Dimensions and Baseboard Keepout Zones .....	140
8.2.2	Boxed Processor Retention Mechanism and Heat Sink Support (URS).....	149
8.3	Fan Power Supply (“Combo” and “Active” Solution) .....	150
8.3.1	Boxed Processor Cooling Requirements.....	151
8.4	Boxed Processor Contents.....	153



## Figures

2-1	Active ODT for a Differential Link Example .....	13
2-2	Input Device Hysteresis .....	14
2-3	VCC Static and Transient Tolerance Loadlines1,2,3,4 .....	31
2-4	VCC Overshoot Example Waveform.....	32
2-5	Load Current Versus Time (130W TDP Processor),2.....	33
2-6	Load Current Versus Time (95W TDP Processor),2 .....	34
2-7	Load Current Versus Time (80W TDP Processor),2 .....	35
2-8	Load Current Versus Time (60W TDP Processor),2 .....	36
2-9	Load Current Versus Time (38W TDP Processor),2 .....	37
2-10	VTT Static and Transient Tolerance Loadlines .....	39
3-1	Processor Package Assembly Sketch .....	43
3-2	Processor Package Drawing (Sheet 1 of 2) .....	45
3-3	Processor Package Drawing (Sheet 2 of 2) .....	46
3-4	Processor Top-Side Markings .....	48
6-1	Intel® Xeon® Processor W5580 Thermal Profile.....	91
6-2	Intel® Xeon® Processor 5500 Series Advanced SKU Thermal Profile.....	93
6-3	Intel Xeon Processor 5500 Series Standard/Basic SKUs Thermal Profile .....	95
6-4	Intel Xeon Processor 5500 Series Low Power SKU Thermal Profile .....	97
6-5	Intel Xeon Processor L5518 Thermal Profile .....	99
6-6	Intel Xeon Processor L5508 Thermal Profile .....	101
6-7	Case Temperature (TCASE) Measurement Location .....	102
6-8	Frequency and Voltage Ordering.....	104
6-9	Ping() .....	108
6-10	Ping() Example .....	108
6-11	GetDIB() .....	109
6-12	Device Info Field Definition .....	109
6-13	Revision Number Definition.....	109
6-14	GetTemp() .....	110
6-15	GetTemp() Example.....	110
6-16	PCI Configuration Address .....	111
6-17	PCIConfigRd() .....	112
6-18	PCIConfigWr() .....	114
6-19	Thermal Status Word .....	116
6-20	Thermal Data Configuration Register.....	117
6-21	Machine Check Read MbxSend() Data Format.....	117
6-22	ACPI T-state Throttling Control Read / Write Definition .....	119
6-23	MbxSend() Command Data Format .....	120
6-24	MbxSend() .....	120
6-25	MbxGet() .....	122
6-26	Temperature Sensor Data Format.....	126
6-27	PECI Power-up Timeline .....	128
7-1	PROCHOT# POC Timing Requirements .....	132
7-2	Power States .....	133
8-1	Boxed Active Heat Sink .....	138
8-2	Boxed Passive / Active Combination Heat Sink (With Removable Fan) .....	138
8-3	Boxed Passive/Active Combination Heat Sink (with Fan Removed) .....	139
8-4	Intel Boxed 25.5 mm Tall Passive Heat Sink Solution .....	139
8-5	Top Side Baseboard Keep-Out Zones .....	141
8-6	Top Side Baseboard Mounting-Hole Keep-Out Zones .....	142
8-7	Bottom Side Baseboard Keep-Out Zones .....	143



8-8	Primary and Secondary Side 3D Height Restriction Zones .....	144
8-9	Volumetric Height Keep-Ins.....	145
8-10	Volumetric Height Keep-Ins.....	146
8-11	4-Pin Fan Cable Connector (For Active Heat Sink) .....	147
8-12	4-Pin Base Baseboard Fan Header (For Active Heat Sink) .....	148
8-13	Thermal Solution Installation.....	150
8-14	Fan Cable Connector Pin Out For 4-Pin Active Thermal Solution.....	151

## Tables

1-1	Intel® Xeon® Processor 5500 Series Feature Set Overview .....	10
1-2	References.....	12
2-1	Processor Power Supply Voltages1 .....	15
2-2	Voltage Identification Definition .....	17
2-3	Power-On Configuration (POC[7:0]) Decode .....	22
2-4	VTT Voltage Identification Definition.....	23
2-5	Signal Groups .....	23
2-6	Signals With On-Die Termination (ODT) .....	25
2-7	Processor Absolute Minimum and Maximum Ratings .....	27
2-8	Voltage and Current Specifications .....	27
2-9	VCC Static and Transient Tolerance .....	30
2-10	VCC Overshoot Specifications .....	31
2-11	VTT Static and Transient Tolerance .....	37
2-12	DDR3 Signal Group DC Specifications .....	39
2-13	PECI DC Electrical Limits.....	40
2-14	RESET# Signal DC Specifications .....	41
2-15	TAP Signal Group DC Specifications .....	41
2-16	PWRGOOD Signal Group DC Specifications .....	41
2-17	Control Sideband Signal Group DC Specifications .....	42
3-1	Processor Loading Specifications .....	47
3-2	Package Handling Guidelines .....	47
3-3	Processor Materials .....	48
4-1	Land Listing by Land Name .....	49
4-2	Land Listing by Land Number .....	67
5-1	Signal Definitions.....	85
6-1	Intel® Xeon® Processor W5580 Thermal Specifications .....	91
6-2	Intel Xeon Processor W5580 Thermal Profile.....	92
6-3	Intel Xeon Processor 5500 Series Advanced SKU Thermal Specifications.....	92
6-4	Intel Xeon Processor 5500 Series Advanced SKU Thermal Profile A .....	94
6-5	Intel Xeon Processor 5500 Series Advanced SKU Thermal Profile B .....	94
6-6	Intel Xeon Processor 5500 Series Standard/Basic SKUs Thermal Specifications.....	95
6-7	Intel Xeon Processor 5500 Series Standard/Basic SKUs Thermal Profile .....	96
6-8	Intel Xeon Processor 5500 Series Low Power SKU Thermal Specifications .....	96
6-9	Intel Xeon Processor 5500 Series Low Power SKU Thermal Profile .....	98
6-10	Intel Xeon Processor L5518 Thermal Specifications.....	98
6-11	Intel Xeon Processor L5518 Thermal Profile .....	100
6-12	Intel Xeon Processor L5508 Thermal Specifications.....	100
6-13	Intel Xeon Processor L5508 Thermal Profile .....	101
6-14	Summary of Processor-specific Peci Commands .....	107
6-15	GetTemp() Response Definition .....	111



6-16	PCIConfigRd() Response Definition .....	112
6-17	PCIConfigWr() Device/Function Support .....	113
6-18	PCIConfigWr() Response Definition .....	114
6-19	Mailbox Command Summary .....	115
6-20	Counter Definition .....	116
6-21	Machine Check Bank Definitions .....	118
6-22	ACPI T-state Duty Cycle Definition .....	119
6-23	MbxSend() Response Definition .....	121
6-24	MbxGet() Response Definition .....	122
6-25	Domain ID Definition .....	124
6-26	Multi-Domain Command Code Reference .....	124
6-27	Completion Code Pass/Fail Mask .....	124
6-28	Device Specific Completion Code (CC) Definition .....	125
6-29	Originator Response Guidelines .....	125
6-30	Error Codes and Descriptions .....	127
6-31	PECI Client Response During Power-Up (During 'Data Not Ready') .....	127
6-32	Power Impact of Peci Commands versus C-states .....	129
6-33	PECI Client Response During S1 .....	129
7-1	Power On Configuration Signal Options .....	131
7-2	Coordination of Thread Power States at the Core Level .....	133
7-3	Processor C-State Power Specifications .....	135
7-4	Processor S-States .....	136
8-1	PWM Fan Frequency Specifications For 4-Pin Active Thermal Solution .....	151
8-2	Fan Specifications For 4-Pin Active Thermal Solution .....	151
8-3	Fan Cable Connector Pin Out for 4-Pin Active Thermal Solution .....	151



## Revision History

---

Document Number	Revision Number	Description	Date
321321	001	<ul style="list-style-type: none"><li>Initial release</li></ul>	March 2009
321321	002	<ul style="list-style-type: none"><li>Added Section 1.3: Statement of Volatility</li></ul>	June 2011

§





# 1 Introduction

---

The Intel® Xeon® processor 5500 series is the first-generation server/workstation multi-core processor to implement key new technologies:

- Integrated Memory Controller
- Point-to-point link interface based on Intel® QuickPath Technology

The processor is optimized for performance with the power efficiencies of a low-power microarchitecture to enable smaller, quieter systems.

This document provides DC electrical specifications, differential signaling specifications, pinout and signal definitions, package mechanical specifications and thermal requirements, and additional features pertinent to implementation and operation of the processor. For information on register descriptions, refer to the *Intel® Xeon® Processor 5500 Series Datasheet, Volume 2*.

Intel Xeon processor 5500 series are multi-core processors, based on 45 nm process technology. The processor family features a range of thermal design power (TDP) envelopes from 38W TDP up to 130W TDP. These processors feature two Intel QuickPath Interconnect point-to-point links capable of up to 6.4 GT/s, up to 8 MB of shared cache, and an Integrated Memory Controller. The processors support all the existing Streaming SIMD Extensions 2 (SSE2), Streaming SIMD Extensions 3 (SSE3) and Streaming SIMD Extensions 4 (SSE4). The processors support several Advanced Technologies: Execute Disable Bit, Intel® 64 Technology, Enhanced Intel SpeedStep® Technology, Intel® Virtualization Technology (Intel® VT), Intel® Hyper-Threading Technology (Intel® HT Technology), and Intel® Turbo Boost Technology (Intel® TBT).

The Intel Xeon processor 5500 series family supports multiple platform segments.

- 2-Socket Workstation Platforms support Intel® Xeon® Processor W5580, a 130W Thermal Design Power (TDP) SKU. These platforms provide optimal overall performance and reliability, in addition to high-end graphics support. Note, specific platform usage conditions apply when implementing these processors.
- 2-Socket High Performance Server and High Performance Computing (HPC) Platforms support Intel Xeon processor 5500 series Advanced SKU (95W TDP). These platforms provide optimal overall performance.
- 2-Socket Volume Server Platforms support Intel Xeon processor 5500 series Standard/Basic SKUs (80W TDP). These platforms provide optimal performance per watt for rack-optimized platforms.
- Ultra Dense Platforms implement Intel Xeon processor 5500 series Low Power SKU (60W TDP). These processors are intended for dual-processor server blades and embedded servers.
- Intel® Xeon® Processor L5518 with 60W TDP and elevated case temperatures. The elevated case temperatures are intended to meet the short-term thermal profile requirements of NEBS Level 3. These 2-Socket processors are ideal for thermally-constrained form factors in embedded servers, comms and storage markets.
- Intel® Xeon® Processor L5508 with 38W TDP and elevated case temperatures. The elevated case temperatures are intended to meet the short-term thermal profile requirements of NEBS Level 3. These 2-Socket processors are ideal for thermally-constrained form factors in embedded servers, comms and storage markets.



- 1-Socket Workstation Platforms support Intel Xeon processor 5500 series SKUs. These platforms enable a wide range of options for either the performance, power, or cost sensitive customer.

**Note:** All references to “chipset” in this document pertain to the Intel® 5520 chipset and Intel® 5500 chipset, unless specifically stated otherwise.

**Table 1-1. Intel® Xeon® Processor 5500 Series Feature Set Overview**

Feature	Intel Xeon Processor 5500 Series
Cache Sizes	- Instruction Cache = 32 KB, per core - Data Cache = 32 KB, per core - 256 KB Mid-Level Cache per core - 8 MB shared among cores (up to 4)
Data Transfer Rate	Two (2) full-width Intel QuickPath Interconnect links, up to 6.4 GT/s in each direction
Multi-Core Support	Up to 4 Cores per processor
Dual Processor Support	Up to 2 processors per platform
Package	1366-land FCLGA

## 1.1 Terminology

A '#' symbol after a signal name refers to an active low signal, indicating a signal is in the active state when driven to a low level. For example, when RESET# is low, a reset has been requested.

A '\_N' and '\_P' after a signal name refers to a differential pair.

Commonly used terms are explained here for clarification:

- **1366-land FC-LGA package** — The Intel Xeon processor 5500 series is available in a Flip-Chip Land Grid Array (FC-LGA) package, consisting of processor mounted on a land grid array substrate with an integrated heat spreader (IHS).
- **DDR3** — Double Data Rate 3 synchronous dynamic random access memory (SDRAM) is the name of the new DDR memory standard that is being developed as the successor to DDR2 SDRAM.
- **Enhanced Intel SpeedStep Technology** — Enhanced Intel SpeedStep Technology allows the operating system to reduce power consumption when performance is not needed.
- **Intel Turbo Boost Technology** — Intel Turbo Boost Technology is a way to automatically run the processor core faster than the marked frequency if the part is operating under power, temperature, and current specifications limits of the Thermal Design Power (TDP). This results in increased performance of both single and multi-threaded applications.
- **Execute Disable Bit** — Execute Disable allows memory to be marked as executable or non-executable, when combined with a supporting operating system. If code attempts to run in non-executable memory the processor raises an error to the operating system. This feature can prevent some classes of viruses or worms that exploit buffer over run vulnerabilities and can thus help improve the overall security of the system. See the *Intel® 64 and IA-32 Architecture Software Developer's Manuals* for more detailed information.
- **Functional Operation** — Refers to the normal operating conditions in which all processor specifications, including DC, AC, signal quality, mechanical, and thermal, are satisfied.



- **Intel Xeon Processor 5500 Series** — Includes processor substrate and integrated heat spreader (IHS).
- **Integrated Memory Controller (IMC)** — As the term implies, the Memory Controller is integrated on the processor die.
- **Intel QuickPath Interconnect (Intel® QPI)** — A cache-coherent, link-based Interconnect specification for Intel processors, chipsets, and I/O bridge components.
- **Intel® 64 Architecture** — An enhancement to Intel's IA-32 architecture, allowing the processor to execute operating systems and applications written to take advantage of Intel® 64.
- **Intel Virtualization Technology (Intel® VT)** — A set of hardware enhancements to Intel server and client platforms that can improve virtualization solutions. VT provides a foundation for widely-deployed virtualization solutions and enables more robust hardware assisted virtualization solution.
- **Integrated Heat Spreader (IHS)** — A component of the processor package used to enhance the thermal performance of the package. Component thermal solutions interface with the processor at the IHS surface.
- **Jitter** — Any timing variation of a transition edge or edges from the defined Unit Interval (UI).
- **LGA1366 Socket** — The 1366-land FC-LGA package mates with the system board through this surface mount, 1366-contact socket.
- **Server SKU** — A processor Stock Keeping Unit (SKU) to be installed in either server or workstation platforms. Electrical, power and thermal specifications for these SKU's are based on specific use condition assumptions. Server processors may be further categorized as Advanced, Standard/Basic, and Low Power SKUs. For further details on use condition assumptions, please refer to the latest Product Release Qualification (PRQ) Report available via your Customer Quality Engineer (CQE) contact.
- **Storage Conditions** — Refers to a non-operational state. The processor may be installed in a platform, in a tray, or loose. Processors may be sealed in packaging or exposed to free air. Under these conditions, processor lands should not be connected to any supply voltages, have any I/Os biased, or receive any clocks.
- **Unit Interval (UI)** — Signaling convention that is binary and unidirectional. In this binary signaling, one bit is sent for every edge of the forwarded clock, whether it be a rising edge or a falling edge. If a number of edges are collected at instances  $t_1, t_2, t_n, \dots, t_k$  then the UI at instance "n" is defined as:

$$UI_n = t_n - t_{n-1}$$

- **Workstation SKU** — A processor SKU to be installed in workstation platforms only. Electrical, power and thermal specifications for these processors have been developed based on Intel's reliability goals at a reference use condition. In addition, the processor validation and production test conditions have been optimized based on these conditions. Operating "Workstation" processors in a server environment or other application, could impact reliability performance, which means Intel's reliability goals may not be met. For further details on use condition assumptions or reliability performance, please refer to the latest Product Release Qualification (PRQ) Report available via your Customer Quality Engineer (CQE) contact.
- **NEBS** — Network Equipment Building System. NEBS is the most common set of environmental design guidelines applied to telecommunications equipment in the United States.



## 1.2 References

Platform designers are strongly encouraged to maintain familiarity with the most up-to-date revisions of processor and platform collateral.

Table 1-2. References

Document	Location	Notes
<i>AP-485, Intel® Processor Identification and the CPUID Instruction</i>	241618	1
<i>Intel® 64 and IA-32 Architecture Software Developer's Manual</i> <ul style="list-style-type: none"><li>• <i>Volume 1: Basic Architecture</i></li><li>• <i>Volume 2A: Instruction Set Reference, A-M</i></li><li>• <i>Volume 2B: Instruction Set Reference, N-Z</i></li><li>• <i>Volume 3A: System Programming Guide, Part 1</i></li><li>• <i>Volume 3B: Systems Programming Guide, Part 2</i></li></ul>	253665 253666 253667 253668 253669	1
<i>Intel® 64 and IA-32 Architectures Optimization Reference Manual</i>	248966	1
<i>Intel® Virtualization Technology Specification for Directed I/O Architecture Specification</i>	D51397-001	1
<i>Intel® Xeon® Processor 5500 Series Datasheet, Volume 2</i>	321322	1
<i>Intel® Xeon® Processor 5500/5600 Series Thermal/Mechanical Design Guide</i>	321323	1
<i>Intel® Xeon® Processor 5500 Series Specification Update</i>	321324	1
<i>Entry-Level Electronics-Bay Specifications: A Server System Infrastructure (SSI) Specification for Entry Pedestal Servers and Workstations</i>	<a href="http://www.ssiforum.org">www.ssiforum.org</a>	
<i>ACPI Specifications</i>	<a href="http://www.acpi.info">www.acpi.info</a>	

**Notes:**

1. Document is available publicly at <http://www.intel.com>.

## 1.3 Statement of Volatility

No Intel Xeon processor 5500 series product family processors retain any end user data when powered down and/or when the parts are physically removed from the socket.





## 2 Intel® Xeon® Processors 5500 Series Electrical Specifications

### 2.1 Processor Signaling

Intel Xeon processor 5500 series include 1366 lands, which utilize various signaling technologies. Signals are grouped by electrical characteristics and buffer type into various signal groups. These include Intel QuickPath Interconnect, DDR3 (Reference Clock, Command, Control and Data), Platform Environmental Control Interface (PECI), Processor Sideband, System Reference Clock, Test Access Port (TAP), and Power/Other signals. Refer to [Table 2-5](#) for details.

Detailed layout, routing, and termination guidelines corresponding to these signal groups can be found in the applicable platform design guide (Refer to [Section 1.2](#)).

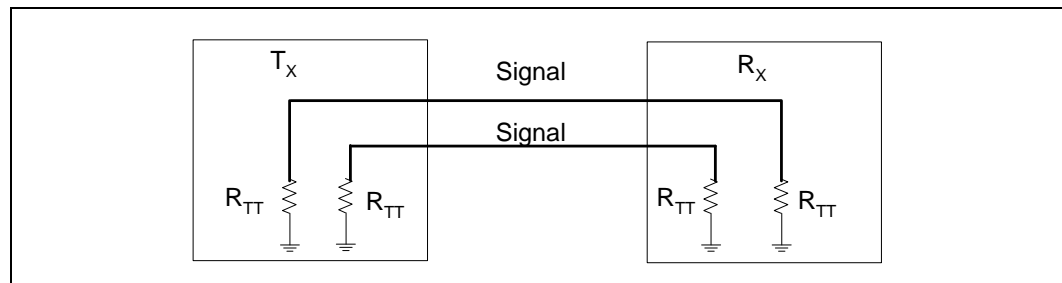
Intel strongly recommends performing analog simulations of all interfaces. Please refer to [Section 1.2](#) for signal integrity model availability.

#### 2.1.1 Intel® QuickPath Interconnect

Intel Xeon processor 5500 series provide two Intel QuickPath Interconnect ports for high speed serial transfer between other enabled components. Each port consists of two uni-directional links (for transmit and receive). A differential signaling scheme is utilized, which consists of opposite-polarity (D<sub>P</sub>, D<sub>N</sub>) signal pairs.

On-die termination (ODT) is included on the processor silicon and terminated to V<sub>SS</sub>. Intel chipsets also provide ODT, thus eliminating the need to terminate on the system board. [Figure 2-1](#) illustrates the active ODT.

**Figure 2-1. Active ODT for a Differential Link Example**



#### 2.1.2 DDR3 Signal Groups

The memory interface utilizes DDR3 technology, which consists of numerous signal groups. These include: Reference Clocks, Command Signals, Control Signals, and Data Signals. Each group consists of numerous signals, which may utilize various signaling technologies. Please refer to [Table 2-5](#) for further details.

### 2.1.3 Platform Environmental Control Interface (PECI)

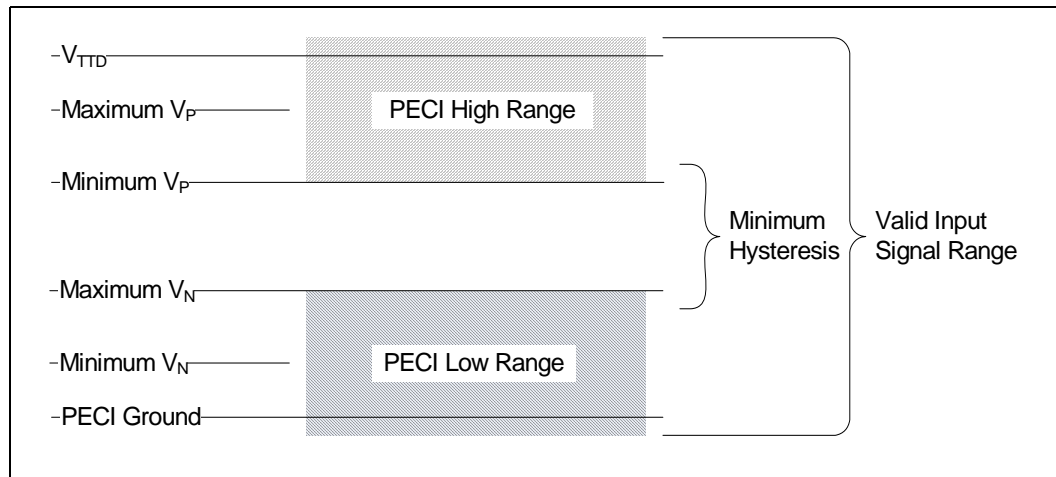
PECI is an Intel proprietary interface that provides a communication channel between Intel processors and chipset components to external thermal monitoring devices. The Intel Xeon Processor 5500 Series contains a Digital Thermal Sensor (DTS) that reports a relative die temperature as an offset from Thermal Control Circuit (TCC) activation temperature. Temperature sensors located throughout the die are implemented as analog-to-digital converters calibrated at the factory. PECI provides an interface for external devices to read processor temperature, perform processor manageability functions, and manage processor interface tuning and diagnostics. Please refer to [Section 6](#) for processor specific implementation details for PECI.

The PECI interface operates at a nominal voltage set by  $V_{TTD}$ . The set of DC electrical specifications shown in [Table 2-13](#) is used with devices normally operating from a  $V_{TTD}$  interface supply.

#### 2.1.3.1 Input Device Hysteresis

The PECI client and host input buffers must use a Schmitt-triggered input design for improved noise immunity. Please refer to [Figure 2-2](#) and [Table 2-13](#).

Figure 2-2. Input Device Hysteresis



### 2.1.4 Processor Sideband Signals

Intel Xeon processor 5500 series include sideband signals that provide a variety of functions. Details can be found in [Table 2-5](#) and the applicable platform design guide.

All Asynchronous Processor Sideband signals are required to be asserted/deasserted for at least eight BCLKs in order for the processor to recognize the proper signal state. See [Table 2-17](#) for DC specifications.

### 2.1.5 System Reference Clock

The processor core, processor uncore, Intel QuickPath Interconnect link, and DDR3 memory interface frequencies are generated from BCLK\_DP and BCLK\_DN signals. There is no direct link between core frequency and Intel QuickPath Interconnect link frequency (for example, no core frequency to Intel QuickPath Interconnect multiplier). The processor maximum core frequency, Intel QuickPath Interconnect link frequency



and DDR3 memory frequency are set during manufacturing. It is possible to override the processor core frequency setting using software. This permits operation at lower core frequencies than the factory set maximum core frequency.

The processor core frequency is configured during reset by using values stored within the device during manufacturing. The stored value sets the lowest core multiplier at which the particular processor can operate. If higher speeds are desired, the appropriate ratio can be configured via the IA32\_PERF\_CTL MSR.

Clock multiplying within the processor is provided by the internal phase locked loop (PLL), which requires a constant frequency BCLK\_DP, BCLK\_DN input, with exceptions for spread spectrum clocking.

### 2.1.6 Test Access Port (TAP) Signals

Due to the voltage levels supported by other components in the Test Access Port (TAP) logic, it is recommended that the processor(s) be first in the TAP chain and followed by any other components within the system. A translation buffer should be used to connect to the rest of the chain unless one of the other components is capable of accepting an input of the appropriate voltage. Similar considerations must be made for TCK, TDO, TMS, and TRST#. Two copies of each signal may be required with each driving a different voltage level.

Processor TAP signal DC specifications can be found in [Table 2-17](#).

**Note:** While TDI, TMS and TRST# do not include On-Die Termination (ODT), these signals are weakly pulled-up via a 1-5 kΩ resistor to  $V_{TT}$ .

**Note:** While TCK does not include ODT, this signal is weakly pulled-down via a 1-5 kΩ resistor to  $V_{SS}$ .

### 2.1.7 Power / Other Signals

Processors also include various other signals including power/ground, sense points, and analog inputs. Details can be found in [Table 2-5](#) and the applicable platform design guide.

[Table 2-1](#) outlines the required voltage supplies necessary to support Intel Xeon processor 5500 series.

**Table 2-1. Processor Power Supply Voltages<sup>1</sup>**

Power Rail	Nominal Voltage	Notes
$V_{CC}$	See <a href="#">Table 2-9</a> ; <a href="#">Figure 2-3</a>	Each processor includes a dedicated VR11.1 regulator.
$V_{CCPLL}$	1.80 V	Each processor includes dedicated $V_{CCPLL}$ and PLL circuits.
$V_{DDQ}$	1.50 V	Each processor and DDR3 stack shares a dedicated voltage regulator.
$V_{TTA}$ , $V_{TTD}$	See <a href="#">Table 2-11</a> ; <a href="#">Figure 2-10</a>	Each processor includes a dedicated VR11.0 regulator. $V_{TT} = V_{TTA} + V_{TTD}$ ; P1V1_Vtt is VID[4:2] controlled, VID range is 1.0255-1.2000 V; 20 mV offset (see <a href="#">Table 2-4</a> ); $V_{TT}$ represents a typical voltage. $V_{TT\_MIN}$ and $V_{TT\_MAX}$ loadlines represent a 31.5 mV offset from $V_{TT}$ (typ).

**Note:**  
1. Refer to [Table 2-8](#) for voltage and current specifications.

Further platform and processor power delivery details can be found in the *Intel® Xeon® Processor 5500 Platform Design Guide (PDG)*.



### 2.1.7.1 Power and Ground Lands

For clean on-chip power distribution, processors include lands for all required voltage supplies. These include:

- 210 each  $V_{CC}$  (271 ea.  $V_{SS}$ ) lands must be supplied with the voltage determined by the VID[7:0] signals. Table 2-2 defines the voltage level associated with each core VID pattern. Table 2-9 and Figure 2-3 represent  $V_{CC}$  static and transient limits.
- 3 each  $V_{CCPLL}$  lands, connected to a 1.8 V supply, power the Phase Lock Loop (PLL) clock generation circuitry. An on-die PLL filter solution is implemented within the Intel Xeon processor 5500 series.
- 45 each  $V_{DDQ}$  (17 ea.  $V_{SS}$ ) lands, connected to a 1.50 V supply, provide power to the processor DDR3 interface. This supply also powers the DDR3 memory subsystem.
- 7 each  $V_{TTA}$  (5 ea.  $V_{SS}$ ) and 26 ea.  $V_{TTD}$  (17 ea.  $V_{SS}$ ) lands must be supplied with the voltage determined by the VTT\_VID[4:2] signals. Coupled with a 20 mV offset, this corresponds to a VTT\_VID pattern of '010xxx10'. Table 2-4 specifies the voltage levels associated with each VTT\_VID pattern. Table 2-11 and Figure 2-10 represent  $V_{TT}$  static and transient limits.

All  $V_{CC}$ ,  $V_{CCPLL}$ ,  $V_{DDQ}$ ,  $V_{TTA}$ , and  $V_{TTD}$  lands must be connected to their respective processor power planes, while all  $V_{SS}$  lands must be connected to the system ground plane. Refer to the *Intel® Xeon® Processor 5500 Platform Design Guide (PDG)* for decoupling, voltage plane and routing guidelines for each power supply voltage.

### 2.1.7.2 Decoupling Guidelines

Due to its large number of transistors and high internal clock speeds, the Intel Xeon processor 5500 series is capable of generating large current swings between low and full power states. This may cause voltages on power planes to sag below their minimum values if bulk decoupling is not adequate. Larger bulk storage ( $C_{BULK}$ ), such as electrolytic capacitors, supply current during longer lasting changes in current demand, for example coming out of an idle condition. Similarly, they act as a storage well for current when entering an idle condition from a running condition. Care must be taken in the baseboard design to ensure that the voltages provided to the processor remains within the specifications listed in Table 2-8. Failure to do so can result in timing violations or reduced lifetime of the processor.

### 2.1.7.3 Processor $V_{CC}$ Voltage Identification (VID) Signals

The voltage set by the VID signals is the maximum reference voltage regulator (VR) output to be delivered to the processor  $V_{CC}$  lands. VID signals are CMOS push/pull outputs. Please refer to Table 2-17 for the DC specifications for these and other processor sideband signals.

Individual processor VID values may be calibrated during manufacturing such that two processor units with the same core frequency may have different default VID settings.

The Intel Xeon processor 5500 series uses eight voltage identification signals, VID[7:0], to support automatic selection of core power supply voltages. Table 2-2 specifies the voltage level corresponding to the state of VID[7:0]. A '1' in this table refers to a high voltage level and a '0' refers to a low voltage level. If the processor socket is empty (SKTOCC# high), or the voltage regulation circuit cannot supply the voltage that is requested, the voltage regulator must disable itself.





The Intel Xeon processor 5500 series provides the ability to operate while transitioning to an adjacent VID and its associated processor core voltage ( $V_{CC}$ ). This is represented by a DC shift in the loadline. It should be noted that a low-to-high or high-to-low voltage state change may result in as many VID transitions as necessary to reach the target core voltage. Transitions above the maximum specified VID are not permitted. [Table 2-8](#) includes VID step sizes and DC shift ranges. Minimum and maximum voltages must be maintained as shown in [Table 2-9](#).

The VRM or EVRD utilized must be capable of regulating its output to the value defined by the new VID. DC specifications for dynamic VID transitions are included in [Table 2-8](#) and [Table 2-9](#).

Power source characteristics must be guaranteed to be stable whenever the supply to the voltage regulator is stable.

**Table 2-2. Voltage Identification Definition (Sheet 1 of 5)**

VID7	VID6	VID5	VID4	VID3	VID2	VID1	VID0	$V_{CC\_MAX}$
0	0	0	0	0	0	0	0	OFF
0	0	0	0	0	0	0	1	OFF
0	0	0	0	0	0	1	0	1.60000
0	0	0	0	0	0	1	1	1.59375
0	0	0	0	0	1	0	0	1.58750
0	0	0	0	0	1	0	1	1.58125
0	0	0	0	0	1	1	0	1.57500
0	0	0	0	0	1	1	1	1.56875
0	0	0	0	1	0	0	0	1.56250
0	0	0	0	1	0	0	1	1.55625
0	0	0	0	1	0	1	0	1.55000
0	0	0	0	1	0	1	1	1.54375
0	0	0	0	1	1	0	0	1.53750
0	0	0	0	1	1	0	1	1.53125
0	0	0	0	1	1	1	0	1.52500
0	0	0	0	1	1	1	1	1.51875
0	0	0	1	0	0	0	0	1.51250
0	0	0	1	0	0	0	1	1.50625
0	0	0	1	0	0	1	0	1.50000
0	0	0	1	0	0	1	1	1.49375
0	0	0	1	0	1	0	0	1.48750
0	0	0	1	0	1	0	1	1.48125
0	0	0	1	0	1	1	0	1.47500
0	0	0	1	0	1	1	1	1.46875
0	0	0	1	1	0	0	0	1.46250
0	0	0	1	1	0	0	1	1.45625
0	0	0	1	1	0	1	0	1.45000
0	0	0	1	1	0	1	1	1.44375
0	0	0	1	1	1	0	0	1.43750
0	0	0	1	1	1	0	1	1.43125



Table 2-2. Voltage Identification Definition (Sheet 2 of 5)

VID7	VID6	VID5	VID4	VID3	VID2	VID1	VID0	V <sub>CC_MAX</sub>
0	0	0	1	1	1	1	0	1.42500
0	0	0	1	1	1	1	1	1.41875
0	0	1	0	0	0	0	0	1.41250
0	0	1	0	0	0	0	1	1.40625
0	0	1	0	0	0	1	0	1.40000
0	0	1	0	0	0	1	1	1.39375
0	0	1	0	0	1	0	0	1.38750
0	0	1	0	0	1	0	1	1.38125
0	0	1	0	0	1	1	0	1.37500
0	0	1	0	0	1	1	1	1.36875
0	0	1	0	1	0	0	0	1.36250
0	0	1	0	1	0	0	1	1.35625
0	0	1	0	1	0	1	0	1.35000
0	0	1	0	1	0	1	1	1.34375
0	0	1	0	1	1	0	0	1.33750
0	0	1	0	1	1	0	1	1.33125
0	0	1	0	1	1	1	0	1.32500
0	0	1	0	1	1	1	1	1.31875
0	0	1	1	0	0	0	0	1.31250
0	0	1	1	0	0	0	1	1.30625
0	0	1	1	0	0	1	0	1.30000
0	0	1	1	0	0	1	1	1.29375
0	0	1	1	0	1	0	0	1.28750
0	0	1	1	0	1	0	1	1.28125
0	0	1	1	0	1	1	0	1.27500
0	0	1	1	0	1	1	1	1.26875
0	0	1	1	1	0	0	0	1.26250
0	0	1	1	1	0	0	1	1.25625
0	0	1	1	1	0	1	0	1.25000
0	0	1	1	1	0	1	1	1.24375
0	0	1	1	1	1	0	0	1.23750
0	0	1	1	1	1	0	1	1.23125
0	0	1	1	1	1	1	0	1.22500
0	0	1	1	1	1	1	1	1.21875
0	1	0	0	0	0	0	0	1.21250
0	1	0	0	0	0	0	1	1.20625
0	1	0	0	0	0	1	0	1.20000
0	1	0	0	0	0	1	1	1.19375
0	1	0	0	0	1	0	0	1.18750
0	1	0	0	0	1	0	1	1.18125
0	1	0	0	0	1	1	0	1.17500
0	1	0	0	0	1	1	1	1.16875



Table 2-2. Voltage Identification Definition (Sheet 3 of 5)

VID7	VID6	VID5	VID4	VID3	VID2	VID1	VID0	V <sub>CC_MAX</sub>
0	1	0	0	1	0	0	0	1.16250
0	1	0	0	1	0	0	1	1.15625
0	1	0	0	1	0	1	0	1.15000
0	1	0	0	1	0	1	1	1.14375
0	1	0	0	1	1	0	0	1.13750
0	1	0	0	1	1	0	1	1.13125
0	1	0	0	1	1	1	0	1.12500
0	1	0	0	1	1	1	1	1.11875
0	1	0	1	0	0	0	0	1.11250
0	1	0	1	0	0	0	1	1.10625
0	1	0	1	0	0	1	0	1.10000
0	1	0	1	0	0	1	1	1.09375
0	1	0	1	0	1	0	0	1.08750
0	1	0	1	0	1	0	1	1.08125
0	1	0	1	0	1	1	0	1.07500
0	1	0	1	0	1	1	1	1.06875
0	1	0	1	1	0	0	0	1.06250
0	1	0	1	1	0	0	1	1.05625
0	1	0	1	1	0	1	0	1.05000
0	1	0	1	1	0	1	1	1.04375
0	1	0	1	1	1	0	0	1.03750
0	1	0	1	1	1	0	1	1.03125
0	1	0	1	1	1	1	0	1.02500
0	1	0	1	1	1	1	1	1.01875
0	1	1	0	0	0	0	0	1.01250
0	1	1	0	0	0	0	1	1.00625
0	1	1	0	0	0	1	0	1.00000
0	1	1	0	0	0	1	1	0.99375
0	1	1	0	0	1	0	0	0.98750
0	1	1	0	0	1	0	1	0.98125
0	1	1	0	0	1	1	0	0.97500
0	1	1	0	0	1	1	1	0.96875
0	1	1	0	1	0	0	0	0.96250
0	1	1	0	1	0	0	1	0.95625
0	1	1	0	1	0	1	0	0.95000
0	1	1	0	1	0	1	1	0.94375
0	1	1	0	1	1	0	0	0.93750
0	1	1	0	1	1	0	1	0.93125
0	1	1	0	1	1	1	0	0.92500
0	1	1	0	1	1	1	1	0.91875
0	1	1	1	0	0	0	0	0.91250
0	1	1	1	0	0	0	1	0.90625



Table 2-2. Voltage Identification Definition (Sheet 4 of 5)

VID7	VID6	VID5	VID4	VID3	VID2	VID1	VID0	V <sub>CC_MAX</sub>
0	1	1	1	0	0	1	0	0.90000
0	1	1	1	0	0	1	1	0.89375
0	1	1	1	0	1	0	0	0.88750
0	1	1	1	0	1	0	1	0.88125
0	1	1	1	0	1	1	0	0.87500
0	1	1	1	0	1	1	1	0.86875
0	1	1	1	1	0	0	0	0.86250
0	1	1	1	1	0	0	1	0.85625
0	1	1	1	1	0	1	0	0.85000
0	1	1	1	1	0	1	1	0.84375
0	1	1	1	1	1	0	0	0.83750
0	1	1	1	1	1	0	1	0.83125
0	1	1	1	1	1	1	0	0.82500
0	1	1	1	1	1	1	1	0.81875
1	0	0	0	0	0	0	0	0.81250
1	0	0	0	0	0	0	1	0.80625
1	0	0	0	0	0	1	0	0.80000
1	0	0	0	0	0	1	1	0.79375
1	0	0	0	0	1	0	0	0.78750
1	0	0	0	0	1	0	1	0.78125
1	0	0	0	0	1	1	0	0.77500
1	0	0	0	0	1	1	1	0.76875
1	0	0	0	1	0	0	0	0.76250
1	0	0	0	1	0	0	1	0.75625
1	0	0	0	1	0	1	0	0.75000
1	0	0	0	1	0	1	1	0.74375
1	0	0	0	1	1	0	0	0.73750
1	0	0	0	1	1	0	1	0.73125
1	0	0	0	1	1	1	0	0.72500
1	0	0	0	1	1	1	1	0.71875
1	0	0	1	0	0	0	0	0.71250
1	0	0	1	0	0	0	1	0.70625
1	0	0	1	0	0	1	0	0.70000
1	0	0	1	0	0	1	1	0.69375
1	0	0	1	0	1	0	0	0.68750
1	0	0	1	0	1	0	1	0.68125
1	0	0	1	0	1	1	0	0.67500
1	0	0	1	0	1	1	1	0.66875
1	0	0	1	1	0	0	0	0.66250
1	0	0	1	1	0	0	1	0.65625
1	0	0	1	1	0	1	0	0.65000
1	0	0	1	1	0	1	1	0.64375



Table 2-2. Voltage Identification Definition (Sheet 5 of 5)

VID7	VID6	VID5	VID4	VID3	VID2	VID1	VID0	V <sub>CC_MAX</sub>
1	0	0	1	1	1	0	0	0.63750
1	0	0	1	1	1	0	1	0.63125
1	0	0	1	1	1	1	0	0.62500
1	0	0	1	1	1	1	1	0.61875
1	0	1	0	0	0	0	0	0.61250
1	0	1	0	0	0	0	1	0.60625
1	0	1	0	0	0	1	0	0.60000
1	0	1	0	0	0	1	1	0.59375
1	0	1	0	0	1	0	0	0.58750
1	0	1	0	0	1	0	1	0.58125
1	0	1	0	0	1	1	0	0.57500
1	0	1	0	0	1	1	1	0.56875
1	0	1	0	1	0	0	0	0.56250
1	0	1	0	1	0	0	1	0.55625
1	0	1	0	1	0	1	0	0.55000
1	0	1	0	1	0	1	1	0.54375
1	0	1	0	1	1	0	0	0.53750
1	0	1	0	1	1	0	1	0.53125
1	0	1	0	1	1	1	0	0.52500
1	0	1	0	1	1	1	1	0.51875
1	0	1	1	0	0	0	0	0.51250
1	0	1	1	0	0	0	1	0.50625
1	0	1	1	0	0	1	0	0.50000
1	1	1	1	1	1	1	0	OFF
1	1	1	1	1	1	1	1	OFF

**Notes:**

1. When the "11111111" VID pattern is observed, or when the SKTOCC# pin is high, the voltage regulator output should be disabled.
2. Shading denotes the expected VID range of the Intel Xeon processor 5500 series.
3. The VID range includes VID transitions that may be initiated by thermal events, Extended HALT state transitions (see [Section 7.2](#)), higher C-States (see [Section 7.2](#)) or Enhanced Intel SpeedStep® Technology transitions (see [Section 7.5](#)). **The Extended HALT state must be enabled for the processor to remain within its specifications.**
4. Once the VRM/EVRD is operating after power-up, if either the Output Enable signal is de-asserted or a specific VID off code is received, the VRM/EVRD must turn off its output (the output should go to high impedance) within 500 ms and latch off until power is cycled.

### 2.1.7.3.1 Power-On Configuration (POC) Logic

VID[7:0] signals also serve a second function. During power-up, Power-On Configuration POC[7:0] functionality is multiplexed onto these signals via 1-5 kΩ pull-up or pull down resistors located on the baseboard. These values provide voltage regulator keying (VID[7]), inform the processor of the platforms power delivery capabilities (MSID[2:0]), and program the gain applied to the ISENSE input (CSC[2:0]). [Table 2-3](#) maps VID signals to the corresponding POC functionality.



**Table 2-3. Power-On Configuration (POC[7:0]) Decode**

Function	Bits	POC Settings		Description
VR_Key	VID[7]	0b for VR11.1		Electronic safety key distinguishing VR11.1
Spare	VID[6]	0b (default)		Reserved for future use
CSC[2:0]	VID[5:3]	-000 -001 -010 -011 -100 -101 -111	Feature Disabled ICC_MAX = 40A ICC_MAX = 50A <sup>1</sup> ICC_MAX = 80A ICC_MAX = 100A ICC_MAX = 120A ICC_MAX = 150A <sup>2</sup>	Current Sensor Configuration (CSC) programs the gain applied to the ISENSE A/D output. ISENSE data is then used to dynamically calculate current and power.
MSID[2:0]	VID[2:0]	-001 -011 -100 -101 -110	38W TDP / 40A ICC_MAX 60W TDP / 80A ICC_MAX 80W TDP / 100A ICC_MAX 95W TDP / 120A ICC_MAX 130W TDP / 150A ICC_MAX	MSID[2:0] signals are provided to indicate the Market Segment for the processor and may be used for future processor compatibility or keying. See <a href="#">Figure 7-1</a> for platform timing requirements of the MSID[2:0] signals.

**Notes:**

1. This setting is defined for future use; no specific Intel Xeon processor 5500 series SKU is defined with ICC\_MAX = 50A
2. General rule: Set PWM IMON slope to: 900 mV=IMAX, where IMAX = IccMAX with one exception: for Intel Xeon Processor W5580 set IMON slope to 900 mV=180A, but for all other SKUs they have to match, as shown above. Consult your PWM data sheet for the IMON slope setting.

Some POC signals include specific timing requirements. Please refer to [Section 7.1](#) for further details.

**2.1.7.4 Processor V<sub>TT</sub> Voltage Identification (VTT\_VID) Signals**

The voltage set by the VTT\_VID signals is the typical reference voltage regulator (VR) output to be delivered to the processor V<sub>TTA</sub> and V<sub>TTD</sub> lands. It is expected that one regulator will supply all V<sub>TTA</sub> and V<sub>TTD</sub> lands. VTT\_VID signals are CMOS push/pull outputs. Please refer to [Table 2-17](#) for the DC specifications for these signals.

Individual processor VTT\_VID values may be calibrated during manufacturing such that two processor units with the same core frequency may have different default VTT\_VID settings.

The Intel Xeon processor 5500 series utilizes three voltage identification signals to support automatic selection of power supply voltages. These correspond to VTT\_VID[4:2]. The V<sub>TT</sub> voltage level delivered to the processor lands must also encompass a 20 mV offset (See [Table 2-4](#); V<sub>TT\_TYP</sub>) above the voltage level corresponding to the state of the VTT\_VID[7:0] signals (See [Table 2-4](#); VR 11.0 Voltage). [Table 2-11](#) and [Figure 2-10](#) provide the resulting static and transient tolerances. Please note that the maximum and minimum electrical loadlines are defined by a 31.5 mV tolerance band above and below V<sub>TT\_TYP</sub> values.

Power source characteristics must be guaranteed to be stable whenever the supply to the voltage regulator is stable.

Table 2-4.  $V_{TT}$  Voltage Identification Definition

VID7	VID6	VID5	VID4	VID3	VID2	VID1	VID0	VR 11.0 Voltage	$V_{TT\_TYP}$ (Voltage + Offset)
0	1	0	0	0	0	1	0	1.200 V	1.220 V
0	1	0	0	0	1	1	0	1.175 V	1.195 V
0	1	0	0	1	0	1	0	1.150 V	1.170 V
0	1	0	0	1	1	1	0	1.125 V	1.145 V
0	1	0	1	0	0	1	0	1.100 V	1.120 V
0	1	0	1	0	1	1	0	1.075 V	1.095 V
0	1	0	1	1	0	1	0	1.050 V	1.070 V
0	1	0	1	1	1	1	0	1.025 V	1.045 V

## 2.1.8 Reserved or Unused Signals

All Reserved (RSVD) signals must remain unconnected. Connection of these signals to  $V_{CC}$ ,  $V_{TTA}$ ,  $V_{TTD}$ ,  $V_{DDQ}$ ,  $V_{SS}$ , or any other signal (including each other) can result in component malfunction or incompatibility with future processors. See [Section 4](#) for the land listing and the location of all Reserved signals.

For reliable operation, connect unused inputs or bidirectional signals to an appropriate signal level. Unused Intel QuickPath Interconnect input and output pins can be left floating. Unused active high inputs should be connected through a resistor to ground ( $V_{SS}$ ). Unused outputs can be left unconnected; however, this may interfere with some TAP functions, complicate debug probing, and prevent boundary scan testing. A resistor must be used when tying bidirectional signals to power or ground. When tying any signal to power or ground, including a resistor will also allow for system testability. Resistor values should be within  $\pm 20\%$  of the impedance of the baseboard trace, unless otherwise noted in the appropriate platform design guidelines.

TAP signals do not include on-die termination, however they may include resistors on package (refer to [Section 2.1.6](#) for details). Inputs and utilized outputs must be terminated on the baseboard. Unused outputs may be terminated on the baseboard or left unconnected. Note that leaving unused outputs unterminated may interfere with some TAP functions, complicate debug probing, and prevent boundary scan testing.

## 2.2 Signal Group Summary

Signals are combined in [Table 2-5](#) by buffer type and characteristics. “Buffer Type” denotes the applicable signaling technology and specifications.

Table 2-5. Signal Groups (Sheet 1 of 2)

Signal Group	Buffer Type	Signals <sup>1</sup>
<b>Intel QuickPath Interconnect Signals</b>		
Differential	Intel QuickPath Interconnect Input	QPI[0/1]_DRX_D[N/P][19:0], QPI[0/1]_CLKRX_DP, QPI[0/1]_CLKRX_DN
Differential	Intel QuickPath Interconnect Output	QPI[0/1]_DTX_D[N/P][19:0], QPI[0/1]_CLKTX_DP, QPI[0/1]_CLKTX_DN
Single ended	Analog Input	QPI[0/1]_COMP
<b>DDR3 Reference Clocks<sup>2</sup></b>		
Differential	Output	DDR{0/1/2}_CLK_[P/N][3:0]



Table 2-5. Signal Groups (Sheet 2 of 2)

Signal Group	Buffer Type	Signals <sup>1</sup>
<b>DDR3 Command Signals<sup>2</sup></b>		
Single ended	CMOS Output	DDR{0/1/2}_RAS#, DDR{0/1/2}_CAS#, DDR{0/1/2}_WE#, DDR{0/1/2}_MA[15:0], DDR{0/1/2}_BA[2:0], DDR{0/1/2}_MA_PAR
Single ended	Asynchronous Output	DDR{0/1/2}_RESET#
<b>DDR3 Control Signals<sup>2</sup></b>		
Single ended	CMOS Output	DDR{0/1/2}_CS#[7:0], DDR{0/1/2}_ODT[5:0], DDR{0/1/2}_CKE[3:0]
Single ended	Analog Input	DDR_VREF, DDR_COMP[2:0]
<b>DDR3 Data Signals<sup>2</sup></b>		
Single ended	CMOS Input/Output	DDR{0/1/2}_DQ[63:0], DDR{0/1/2}_ECC[7:0]
Differential	CMOS Input/Output	DDR{0/1/2}_DQS_[N/P][17:0]
Single ended	Asynchronous Input	DDR{0/1/2}_PAR_ERR#[2:0], DDR_THERM#
<b>Platform Environmental Control Interface (PECI)</b>		
Single ended	Asynchronous Input/Output	PECI
<b>Processor Sideband Signals</b>		
Single ended	GTL Input/Output	BPM#[7:0], CAT_ERR#
Single ended	Asynchronous Input	PECI_ID#
Single ended	Asynchronous GTL Output	PRDY#, THERMTRIP#
Single ended	Asynchronous GTL Input	PREQ#
Single ended	Asynchronous GTL Input/Output	PROCHOT#
Single ended	Asynchronous CMOS Output	PSI#
Single ended	CMOS Output	VID[7:6], VID[5:3]/CSC[2:0], VID[2:0]/MSID[2:0], VTT_VID[4:2]
<b>System Reference Clock</b>		
Differential	Input	BCLK_DP, BCLK_DN
<b>Test Access Port (TAP) Signals</b>		
Differential	CMOS Output	BCLK_ITP_DP, BCLK_ITP_DN
Single ended	Input	TCK, TDI, TMS, TRST#
Single ended	GTL Output	TDO
<b>PWRGOOD Signals</b>		
Single ended	Asynchronous Input	CCPWRGOOD, VDDPWRGOOD, VTPWRGOOD
<b>RESET Signal</b>		
Single ended	Asynchronous Input	RESET#
<b>Power/Other Signals</b>		
	Power / Ground	V <sub>CC</sub> , V <sub>CCPLL</sub> , V <sub>DDQ</sub> , V <sub>TTA</sub> , V <sub>TTD</sub> , V <sub>SS</sub>
	Analog Input	COMPO, ISENSE
	Sense Points	V <sub>CCSENSE</sub> , V <sub>SSSENSE</sub> , V <sub>SS_SENSE_VTTD</sub> , V <sub>TTD_SENSE</sub>
	Other	SKTOCC#, DBR#



**Notes:**

1. Refer to [Section 4](#) for land assignments and [Section 5](#) for signal definitions.
2. DDR{0/1/2} refers to DDR3 Channel 0, DDR3 Channel1 and DDR3 Channel 2.

Signals that include on-die termination (ODT) are listed in [Table 2-6](#).

**Table 2-6. Signals With On-Die Termination (ODT)**

<b>Intel QuickPath Interface Signal Group<sup>1</sup></b>
QPI[1:0]_DRX_DP[19:0], QPI[1:0]_DRX_DN[19:0], QPI[1:0]_TRX_DP[19:0], QPI[1:0]_TRX_DN[19:0], QPI[0/1]_CLKRX_D[N/P], QPI[0/1]_CLKTX_D[N/P]
<b>DDR3 Signal Group<sup>2</sup></b>
DDR{0/1/2}_DQ[63:0], DDR{0/1/2}_DQS_[N/P][17:0], DDR{0/1/2}_ECC[7:0], DDR{0/1/2}_PAR_ERR#[2:0] <sup>3</sup>
<b>Processor Sideband Signal Group</b>
BPM#[7:0] <sup>6</sup> , PECL_ID# <sup>7</sup> , PREQ# <sup>6</sup>
<b>Test Access Port (TAP) Signal Group</b>
TCK <sup>4</sup> , TDI <sup>5</sup> , TMS <sup>5</sup> , TRST# <sup>5</sup>
<b>Power/Other Signal Group<sup>8</sup></b>
VCCPWRGOOD, VDDPWRGOOD, VTTPWRGOOD

**Notes:**

1. Unless otherwise specified, signals have ODT in the package with a 50  $\Omega$  pull-down to  $V_{SS}$ .
2. Unless otherwise specified, all DDR3 signals are terminated to  $V_{DDQ}/2$ .
3. DDR{0/1/2}\_PAR\_ERR#[2:0] are terminated to  $V_{DDQ}$ .
4. TCK does not include ODT, this signal is weakly pulled-down via a 1-5 k $\Omega$  resistor to  $V_{SS}$ .
5. TDI, TMS, TRST# do not include ODT, these signals are weakly pulled-up via 1-5k $\Omega$  resistor to  $V_{TT}$ .
6. BPM[7:0]# and PREQ# signals have ODT in package with 35  $\Omega$  pull-ups to  $V_{TT}$ .
7. PECL\_ID# has ODT in package with a 1-5 k $\Omega$  pull-up to  $V_{TT}$ .
8. VCCPWRGOOD, VDDPWRGOOD, and VTTPWRGOOD have ODT in package with a 5-20 k $\Omega$  pull-down to  $V_{SS}$ .

## 2.3 Mixing Processors

Intel supports dual processor (DP) configurations consisting of processors:

1. from the same power optimization segment
2. that support the same maximum Intel QuickPath Interconnect and DDR3 memory speeds
3. that share symmetry across physical packages with respect to the number of logical processor per package, number of cores per package, number of Intel QuickPath interfaces, and cache topology
4. that have identical Extended Family, Extended Model, Processor Type, Family Code and Model Number as indicated by the function 1 of the CPUID instruction

**Note:** Processors must operate with the same Intel QuickPath Interconnect, DDR3 memory, and core frequency.

While Intel does nothing to prevent processors from operating together, some combinations may not be supported due to limited validation, which may result in uncharacterized errata. Coupling this fact with the large number of Intel Xeon processor 5500 series attributes, the following population rules and stepping matrix have been developed to clearly define supported configurations.

1. Processors must be of the same power-optimization segment. This insures processors include the same maximum Intel QuickPath Interconnect and DDR3 operating speeds and cache sizes.



- Processors must operate at the same core frequency. Note, processors within the same power-optimization segment supporting different maximum core frequencies (for example, a 2.93 GHz / 95 W and 2.66 GHz / 95 W) can be operated within a system. However, both must operate at the highest frequency rating commonly supported. Mixing components operating at different internal clock frequencies is not supported and will not be validated by Intel.
- Processors must share symmetry across physical packages with respect to the number of logical processors per package, number of cores per package (but not necessarily the same subset of cores within the packages), number of Intel QuickPath Interconnect interfaces, and cache topology.
- Mixing dissimilar steppings is only supported with processors that have identical Extended Family, Extended Model, Processor Type, Family Code and Model Number as indicated by the function 1 of the CPUID instruction. Mixing processors of different steppings but the same model (as per CPUID instruction) is supported. Details regarding the CPUID instruction are provided in the *AP-485, Intel® Processor Identification and the CPUID Instruction application note* and the *Intel® 64 and IA-32 Architectures Software Developer's Manual, Volume 2A*.
- After AND'ing the feature flag and extended feature flags from the installed processors, any processor whose set of feature flags exactly matches the AND'ed feature flags can be selected by the BIOS as the BSP. If no processor exactly matches the AND'ed feature flag values, then the processor with the numerically lower CPUID should be selected as the BSP.
- Intel requires that the proper microcode update be loaded on each processor operating within the system. Any processor that does not have the proper microcode update loaded is considered by Intel to be operating out of specification.
- Customers are fully responsible for the validation of their system configuration.

## 2.4 Flexible Motherboard Guidelines (FMB)

The Flexible Motherboard (FMB) guidelines are estimates of the maximum values the Intel Xeon processor 5500 series will have over certain time periods. The values are only estimates and actual specifications for future processors may differ. Processors may or may not have specifications equal to the FMB value in the foreseeable future. System designers should meet the FMB values to ensure their systems will be compatible with future Intel Xeon processor 5500 series.

## 2.5 Absolute Maximum and Minimum Ratings

Table 2-7 specifies absolute maximum and minimum ratings which lie outside the functional limits of the processor. Only within specified operation limits, can functionality and long-term reliability be expected.

At conditions outside functional operation condition limits, but within absolute maximum and minimum ratings, neither functionality nor long-term reliability can be expected. If a device is returned to conditions within functional operation limits after having been subjected to conditions outside these limits, but within the absolute maximum and minimum ratings, the device may be functional, but with its lifetime degraded depending on exposure to conditions exceeding the functional operation condition limits.



At conditions exceeding absolute maximum and minimum ratings, neither functionality nor long-term reliability can be expected. Moreover, if a device is subjected to these conditions for any length of time then, when returned to conditions within the functional operating condition limits, it will either not function or its reliability will be severely degraded.

Although the processor contains protective circuitry to resist damage from static electric discharge, precautions should always be taken to avoid high static voltages or electric fields.

**Table 2-7. Processor Absolute Minimum and Maximum Ratings**

Symbol	Parameter	Min	Nominal	Max	Unit	Notes <sup>1,2</sup>
V <sub>CC</sub>	Processor core voltage with respect to V <sub>SS</sub>	-0.300		1.350	V	
V <sub>CCPLL</sub>	Processor PLL voltage with respect to V <sub>SS</sub>		1.800		V	4
V <sub>DDQ</sub>	Processor I/O supply voltage for DDR3 with respect to V <sub>SS</sub>		1.500		V	4
V <sub>TTA</sub>	Processor uncore analog voltage with respect to V <sub>SS</sub>	0.825		1.350	V	3
V <sub>TTD</sub>	Processor uncore digital voltage with respect to V <sub>SS</sub>	0.825		1.350	V	3
T <sub>CASE</sub>	Processor case temperature	See Section 6		See Section 6	°C	
T <sub>STORAGE</sub>	Storage temperature	-40		85	°C	5,6,7
V <sub>ISENSE</sub>	Analog input voltage with respect to V <sub>SS</sub> for sensing Core current consumption	-0.30		1.150	V	

**Notes:**

1. For functional operation, all processor electrical, signal quality, mechanical and thermal specifications must be satisfied.
2. Excessive overshoot or undershoot on any signal will likely result in permanent damage to the processor.
3. V<sub>TTA</sub> and V<sub>TTD</sub> should be derived from the same voltage regulator (VR).
4. ±5% tolerance.
5. Storage temperature is applicable to storage conditions only. In this scenario, the processor must not receive a clock, and no lands can be connected to a voltage bias. Storage within these limits will not affect the long-term reliability of the device. For functional operation, please refer to the processor case temperature specifications.
6. This rating applies to the processor and does not include any tray or packaging.
7. Failure to adhere to this specification can affect the long-term reliability of the processor.

## 2.6 Processor DC Specifications

**DC specifications are defined at the processor pads, unless otherwise noted.**

DC specifications are only valid while meeting specifications for case temperature (T<sub>CASE</sub> specified in Section 6), clock frequency, and input voltages. Care should be taken to read all notes associated with each specification.

**Table 2-8. Voltage and Current Specifications (Sheet 1 of 3)**

Symbol	Parameter	Voltage Plane	Min	Typ	Max	Unit	Notes <sup>1</sup>
VID	V <sub>CC</sub> VID Range	-	0.750		1.350	V	2,3
V <sub>CC</sub>	Core Voltage (Launch - FMB)	V <sub>CC</sub>	See Table 2-9 and Figure 2-3			V	3,4,6,7,11
V <sub>VID_STEP</sub>	VID step size during a transition	-			± 6.250	mV	9
V <sub>CCPLL</sub>	PLL Voltage (DC + AC specification)	V <sub>CCPLL</sub>	0.95*V <sub>CCPLL</sub> (Typ)	1.800	1.05*V <sub>CCPLL</sub> (Typ)	V	10



Table 2-8. Voltage and Current Specifications (Sheet 2 of 3)

Symbol	Parameter	Voltage Plane	Min	Typ	Max	Unit	Notes <sup>1</sup>
V <sub>DDQ</sub>	I/O Voltage for DDR3 (DC + AC specification)	V <sub>DDQ</sub>	0.95*V <sub>DDQ</sub> (Typ)	1.500	1.05*V <sub>DDQ</sub> (Typ)	V	10
VTT_VID	V <sub>TT</sub> VID Range	-	1.045		1.220	V	2,3
V <sub>TT</sub>	Uncore Voltage (Launch - FMB)	V <sub>TT</sub>	See Table 2-11 and Figure 2-10			V	3,5,8,11
I <sub>CC_MAX</sub> I <sub>CCPLL_MAX</sub> I <sub>DDQ_MAX</sub> I <sub>TT_MAX</sub>	Max. Processor Current: Intel® Xeon® Processor W5580 (TDP = 130W) (Launch - FMB)	V <sub>CC</sub> V <sub>CCPLL</sub> V <sub>DDQ</sub> V <sub>TTA</sub> V <sub>TTD</sub>			150 1.1 9 6 22	A A A A A	11
	Max. Processor Current: Intel Xeon Processor 5500 Series Advanced SKU (TDP = 95W) (Launch - FMB)	V <sub>CC</sub> V <sub>CCPLL</sub> V <sub>DDQ</sub> V <sub>TTA</sub> V <sub>TTD</sub>			120 1.1 9 6 22	A A A A A	11
	Max. Processor Current: Intel Xeon Processor 5500 Series Standard/Basic SKU (TDP = 80W) (Launch - FMB)	V <sub>CC</sub> V <sub>CCPLL</sub> V <sub>DDQ</sub> V <sub>TTA</sub> V <sub>TTD</sub>			100 1.1 9 6 22	A A A A A	11
	Max. Processor Current: Intel Xeon Processor 5500 Series Low Power SKU (TDP = 60W) (Launch - FMB)	V <sub>CC</sub> V <sub>CCPLL</sub> V <sub>DDQ</sub> V <sub>TTA</sub> V <sub>TTD</sub>			80 1.1 9 6 20	A A A A A	11
	Max. Processor Current: Intel® Xeon® Processor L5518 (TDP = 60W) (Launch - FMB)	V <sub>CC</sub> V <sub>CCPLL</sub> V <sub>DDQ</sub> V <sub>TTA</sub> V <sub>TTD</sub>			80 1.1 9 6 20	A A A A A	11
	Max. Processor Current: Intel® Xeon® Processor L5508 (TDP = 38W) (Launch - FMB)	V <sub>CC</sub> V <sub>CCPLL</sub> V <sub>DDQ</sub> V <sub>TTA</sub> V <sub>TTD</sub>			40 1.1 9 6 20	A A A A A	11



Table 2-8. Voltage and Current Specifications (Sheet 3 of 3)

Symbol	Parameter	Voltage Plane	Min	Typ	Max	Unit	Notes <sup>1</sup>
I <sub>CC_TDC</sub> I <sub>CCPLL_TDC</sub> I <sub>DDQ_TDC</sub> I <sub>TT_TDC</sub>	Thermal Design Current: Intel Xeon Processor W5580 (TDP = 130W) (Launch - FMB)	V <sub>CC</sub> V <sub>CCPLL</sub> V <sub>DDQ</sub> V <sub>TTA</sub> V <sub>TTD</sub>			110 1.1 9 6 22	A A A A A	11,12
	Thermal Design Current: Intel Xeon Processor 5500 Series Advanced SKU (TDP = 95W) (Launch - FMB)	V <sub>CC</sub> V <sub>CCPLL</sub> V <sub>DDQ</sub> V <sub>TTA</sub> V <sub>TTD</sub>			85 1.1 9 6 22	A A A A A	11,12
	Thermal Design Current: Intel Xeon Processor 5500 Series Standard/Basic SKU (TDP = 80W) (Launch - FMB)	V <sub>CC</sub> V <sub>CCPLL</sub> V <sub>DDQ</sub> V <sub>TTA</sub> V <sub>TTD</sub>			70 1.1 9 6 22	A A A A A	11,12
	Thermal Design Current: Intel Xeon Processor 5500 Series Low Power SKU (TDP = 60W) (Launch - FMB)	V <sub>CC</sub> V <sub>CCPLL</sub> V <sub>DDQ</sub> V <sub>TTA</sub> V <sub>TTD</sub>			60 1.1 9 6 20	A A A A A	11,12
	Thermal Design Current: Intel Xeon Processor L5518 (TDP = 60W) (Launch - FMB)	V <sub>CC</sub> V <sub>CCPLL</sub> V <sub>DDQ</sub> V <sub>TTA</sub> V <sub>TTD</sub>			60 1.1 9 6 20	A A A A A	11,12
	Thermal Design Current: Intel Xeon Processor L5508 (TDP = 38W) (Launch - FMB)	V <sub>CC</sub> V <sub>CCPLL</sub> V <sub>DDQ</sub> V <sub>TTA</sub> V <sub>TTD</sub>			28 1.1 9 6 20	A A A A A	11,12
	I <sub>DDQ_S3</sub>	DDR3 System Memory Interface Supply Current in Standby State	V <sub>DDQ</sub>			1.0	A

**Notes:**

1. Unless otherwise noted, all specifications in this table apply to all processors. These specifications are based on pre-silicon characterization and will be updated as further data becomes available.
2. Individual processor VID and/or VTT\_VID values may be calibrated during manufacturing such that two devices at the same speed may have different settings.
3. These voltages are targets only. A variable voltage source should exist on systems in the event that a different voltage is required.
4. The V<sub>CC</sub> voltage specification requirements are measured across vias on the platform for the VCCSENSE and VSSSENSE pins close to the socket with a 100 MHz bandwidth oscilloscope, 1.5 pF maximum probe capacitance, and 1 MΩ minimum impedance. The maximum length of ground wire on the probe should be less than 5 mm. Ensure external noise from the system is not coupled in the scope probe.
5. The V<sub>TT</sub> voltage specification requirements are measured across vias on the platform for the VTTD\_SENSE and VSS\_SENSE\_VTTD lands close to the socket with a 100 MHz bandwidth oscilloscope, 1.5 pF maximum probe capacitance, and 1 MΩ minimum impedance. The maximum length of ground wire on the probe should be less than 5 mm. Ensure external noise from the system is not coupled in the scope probe.
6. Refer to Table 2-9 and corresponding Figure 2-3. The processor should not be subjected to any static V<sub>CC</sub> level that exceeds the V<sub>CC\_MAX</sub> associated with any particular current. Failure to adhere to this specification can shorten processor lifetime.
7. Minimum V<sub>CC</sub> and maximum I<sub>CC</sub> are specified at the maximum processor case temperature (T<sub>CASE</sub>) shown in Table 6-1. I<sub>CC\_MAX</sub> is specified at the relative V<sub>CC\_MAX</sub> point on the V<sub>CC</sub> load line. The processor is capable of



- drawing  $I_{CC\_MAX}$  for up to 10 ms. Refer to Figure 2-5 through Figure 2-8 for further details on the average processor current draw over various time durations.
8. Refer to Table 2-11 and corresponding Figure 2-10. The processor should not be subjected to any static  $V_{TT}$  level that exceeds the  $V_{TT\_MAX}$  associated with any particular current. Failure to adhere to this specification can shorten processor lifetime.
  9. This specification represents the  $V_{CC}$  reduction due to each VID transition. See Section 2.1.7.3.
  10. Baseboard bandwidth is limited to 20 MHz.
  11. FMB is the flexible motherboard guidelines. See Section 2.4 for FMB details.
  12.  $ICC\_TDC$  (Thermal Design Current) is the sustained (DC equivalent) current that the processor is capable of drawing indefinitely and should be used for the voltage regulator temperature assessment. The voltage regulator is responsible for monitoring its temperature and asserting the necessary signal to inform the processor of a thermal excursion.
  13. Specification is at  $T_{CASE} = 50^{\circ}C$ .
  14. Characterized by design (not tested).

**Table 2-9.  $V_{CC}$  Static and Transient Tolerance**

$I_{CC}$ (A)	$V_{CC\_MAX}$ (V)	$V_{CC\_TYP}$ (V)	$V_{CC\_MIN}$ (V)	Notes <sup>1,2,3,4</sup>
0	VID - 0.000	VID - 0.015	VID - 0.030	
5	VID - 0.004	VID - 0.019	VID - 0.034	
10	VID - 0.008	VID - 0.023	VID - 0.038	
15	VID - 0.012	VID - 0.027	VID - 0.042	
20	VID - 0.016	VID - 0.031	VID - 0.046	
25	VID - 0.020	VID - 0.035	VID - 0.050	
30	VID - 0.024	VID - 0.039	VID - 0.054	
35	VID - 0.028	VID - 0.043	VID - 0.058	
40	VID - 0.032	VID - 0.047	VID - 0.062	
45	VID - 0.036	VID - 0.051	VID - 0.066	
50	VID - 0.040	VID - 0.055	VID - 0.070	
55	VID - 0.044	VID - 0.059	VID - 0.074	
60	VID - 0.048	VID - 0.063	VID - 0.078	
65	VID - 0.052	VID - 0.067	VID - 0.082	
70	VID - 0.056	VID - 0.071	VID - 0.086	
75	VID - 0.060	VID - 0.075	VID - 0.090	
80	VID - 0.064	VID - 0.079	VID - 0.094	
85	VID - 0.068	VID - 0.083	VID - 0.098	
90	VID - 0.072	VID - 0.087	VID - 0.102	
95	VID - 0.076	VID - 0.091	VID - 0.106	
100	VID - 0.080	VID - 0.095	VID - 0.110	
105	VID - 0.084	VID - 0.099	VID - 0.114	
110	VID - 0.088	VID - 0.103	VID - 0.118	
115	VID - 0.092	VID - 0.107	VID - 0.122	
120	VID - 0.096	VID - 0.111	VID - 0.126	
125	VID - 0.100	VID - 0.115	VID - 0.130	
130	VID - 0.104	VID - 0.119	VID - 0.134	
135	VID - 0.108	VID - 0.123	VID - 0.138	
140	VID - 0.112	VID - 0.127	VID - 0.142	
145	VID - 0.116	VID - 0.131	VID - 0.146	
150	VID - 0.120	VID - 0.135	VID - 0.150	

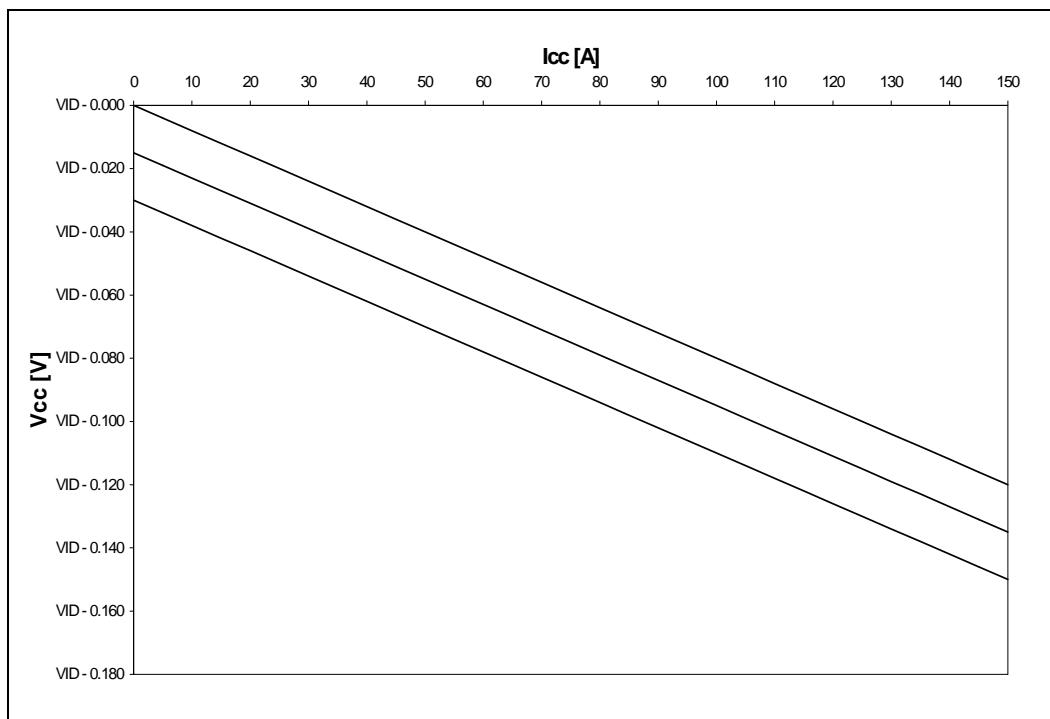
**Notes:**

1. The  $V_{CC\_MIN}$  and  $V_{CC\_MAX}$  loadlines represent static and transient limits. Please see Section 2.6.1 for  $V_{CC}$  overshoot specifications.



2. This table is intended to aid in reading discrete points on [Figure 2-3](#).
3. The loadlines specify voltage limits at the die measured at the VCC\_SENSE and VSS\_SENSE lands. Voltage regulation feedback for voltage regulator circuits must also be taken from processor VCC\_SENSE and VSS\_SENSE lands. Please refer to the appropriate platform design guide for further details on regulator and decoupling implementations.
4. Processor core current ( $I_{CC}$ ) ranges are valid up to  $I_{CC\_MAX}$  of the processor SKU as defined in [Table 2-8](#), "Voltage and Current Specifications".

**Figure 2-3. V<sub>CC</sub> Static and Transient Tolerance Loadlines<sup>1,2,3,4</sup>**



**Notes:**

1. The  $V_{CC\_MIN}$  and  $V_{CC\_MAX}$  loadlines represent static and transient limits. Please see [Section 2.6.1](#) for  $V_{CC}$  overshoot specifications.
2. Refer to [Table 2-9](#) for  $V_{CC}$  Static and Transient Tolerance.
3. The loadlines specify voltage limits at the die measured at the VCC\_SENSE and VSS\_SENSE lands. Voltage regulation feedback for voltage regulator circuits must also be taken from processor VCC\_SENSE and VSS\_SENSE lands. Please refer to the appropriate platform design guide for further details on regulator and decoupling implementations.
4. Processor core current ( $I_{CC}$ ) ranges are valid up to  $I_{CC\_MAX}$  of the processor SKU as defined in [Table 2-8](#).

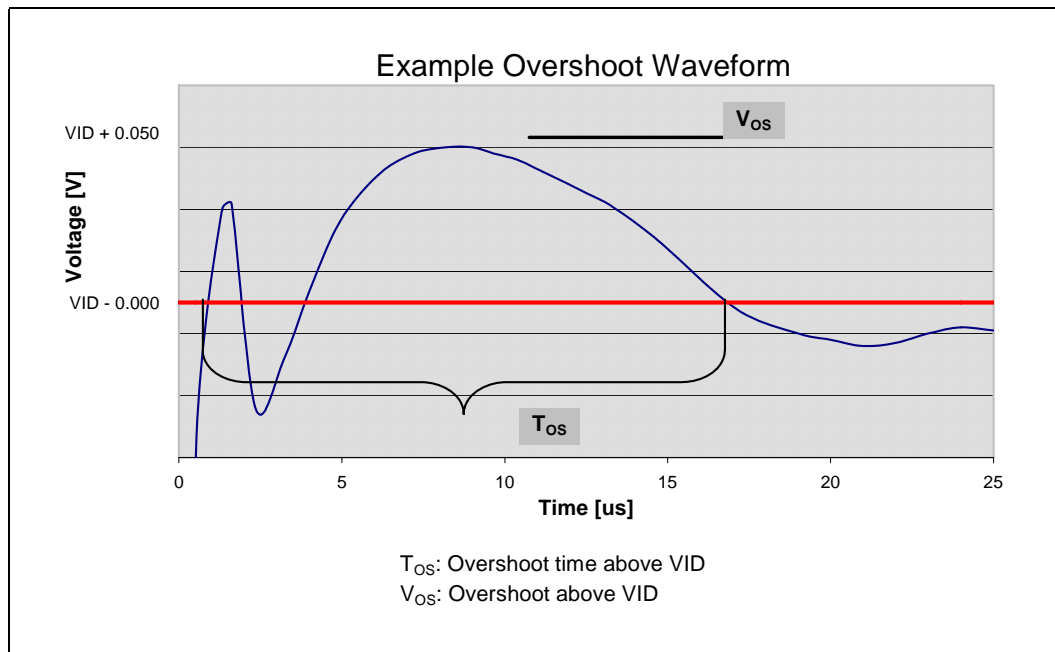
## 2.6.1 V<sub>CC</sub> Overshoot Specifications

The Intel Xeon Processor 5500 Series can tolerate short transient overshoot events where  $V_{CC}$  exceeds the VID voltage when transitioning from a high-to-low current load condition. This overshoot cannot exceed  $VID + V_{OS\_MAX}$  ( $V_{OS\_MAX}$  is the maximum allowable overshoot above VID). These specifications apply to the processor die voltage as measured across the VCC\_SENSE and VSS\_SENSE lands.

**Table 2-10. V<sub>CC</sub> Overshoot Specifications**

Symbol	Parameter	Min	Max	Units	Figure	Notes
$V_{OS\_MAX}$	Magnitude of $V_{CC}$ overshoot above VID	-	50	mV	2-4	
$T_{OS\_MAX}$	Time duration of $V_{CC}$ overshoot above VID	-	25	µs	2-4	

Figure 2-4.  $V_{CC}$  Overshoot Example Waveform



**Notes:**

1.  $V_{OS}$  is the measured overshoot voltage.
2.  $T_{OS}$  is the measured time duration above VID.

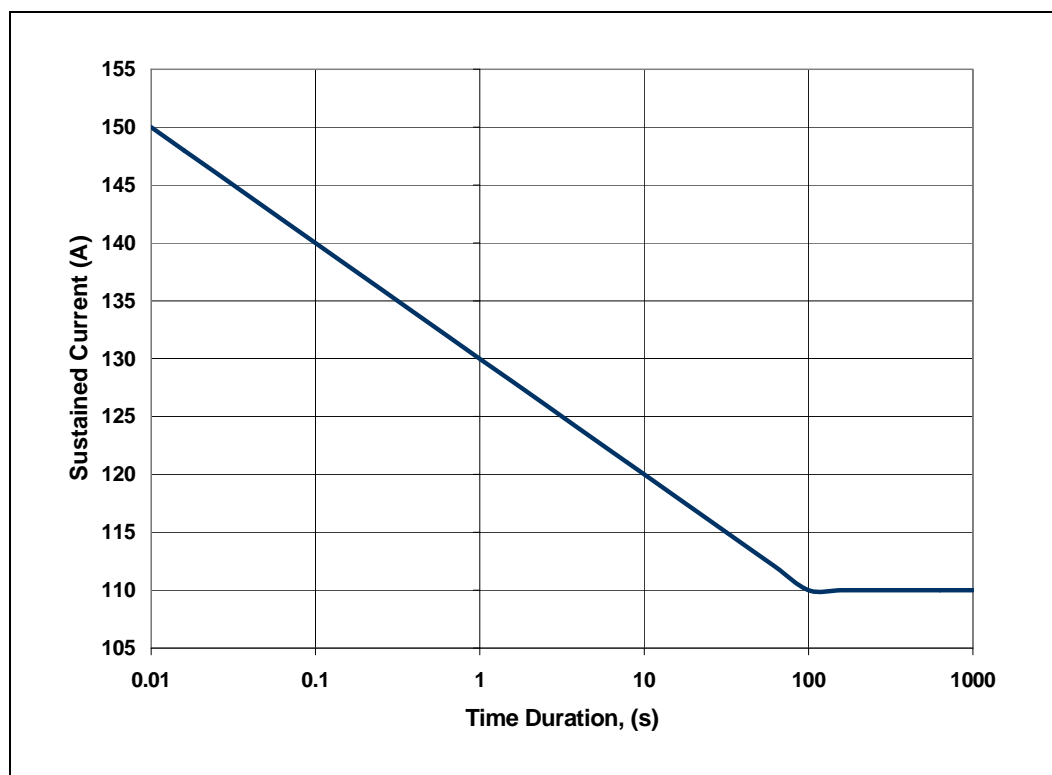
## 2.6.2 Die Voltage Validation

Core voltage ( $V_{CC}$ ) overshoot events at the processor must meet the specifications in [Table 2-10](#) when measured across the VCC\_SENSE and VSS\_SENSE lands. Overshoot events that are < 10 ns in duration may be ignored. These measurements of processor die level overshoot should be taken with a 100 MHz bandwidth limited oscilloscope.





Figure 2-5. Load Current Versus Time (130W TDP Processor)<sup>1,2</sup>



**Notes:**

1. Processor or voltage regulator thermal protection circuitry should not trip for load currents greater than  $I_{CC\_TDC}$ .
2. Not 100% tested. Specified by design characterization.

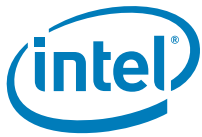
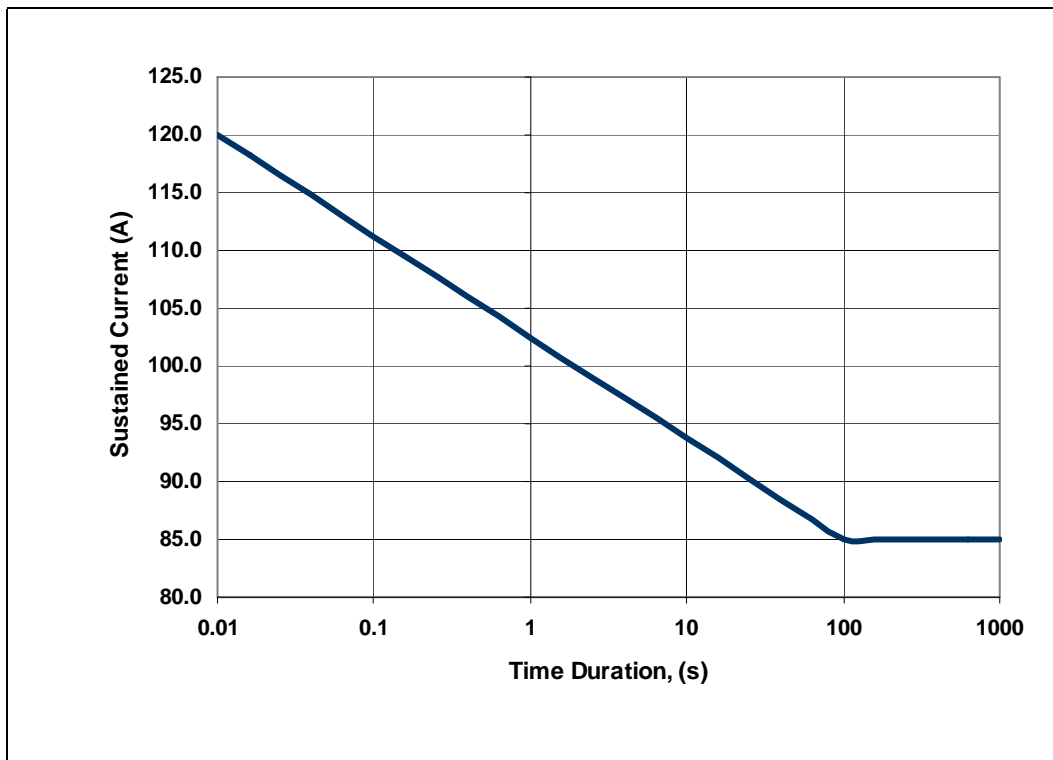


Figure 2-6. Load Current Versus Time (95W TDP Processor)<sup>1,2</sup>

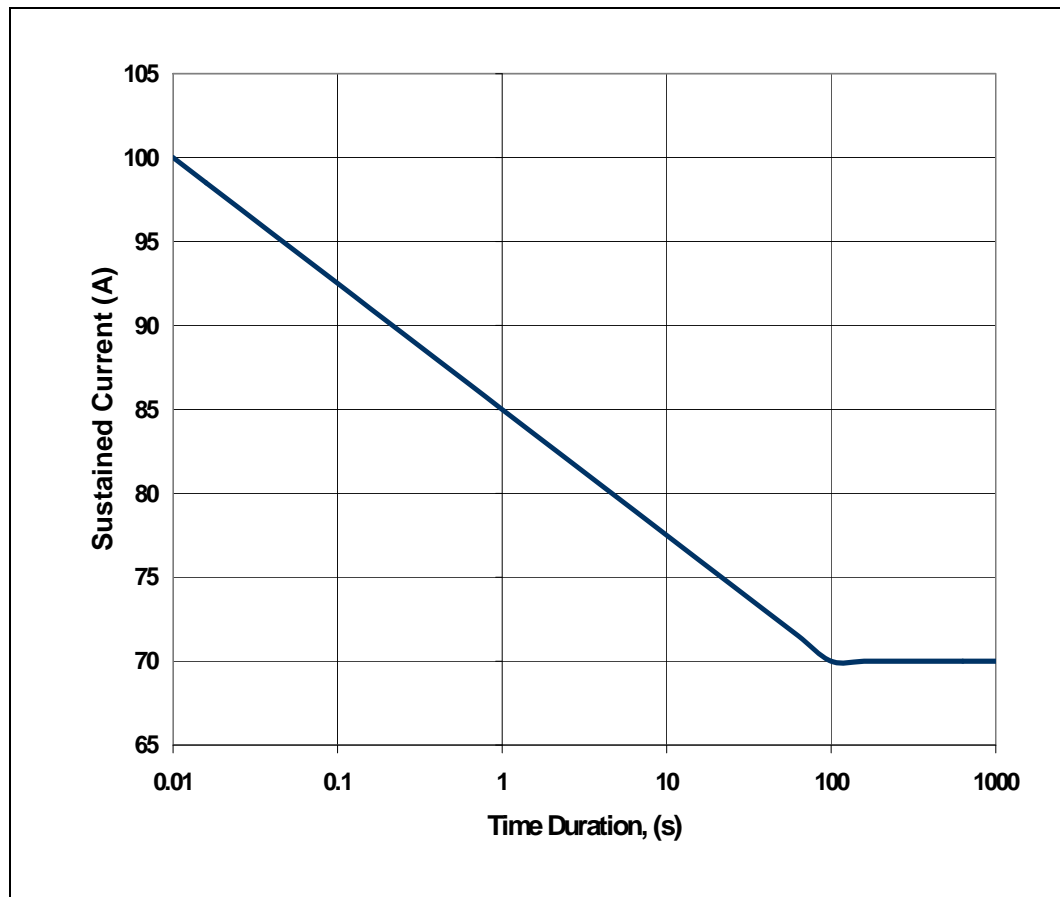


Notes:

1. Processor or voltage regulator thermal protection circuitry should not trip for load currents greater than  $I_{CC\_TDC}$ .
2. Not 100% tested. Specified by design characterization.



Figure 2-7. Load Current Versus Time (80W TDP Processor)<sup>1,2</sup>

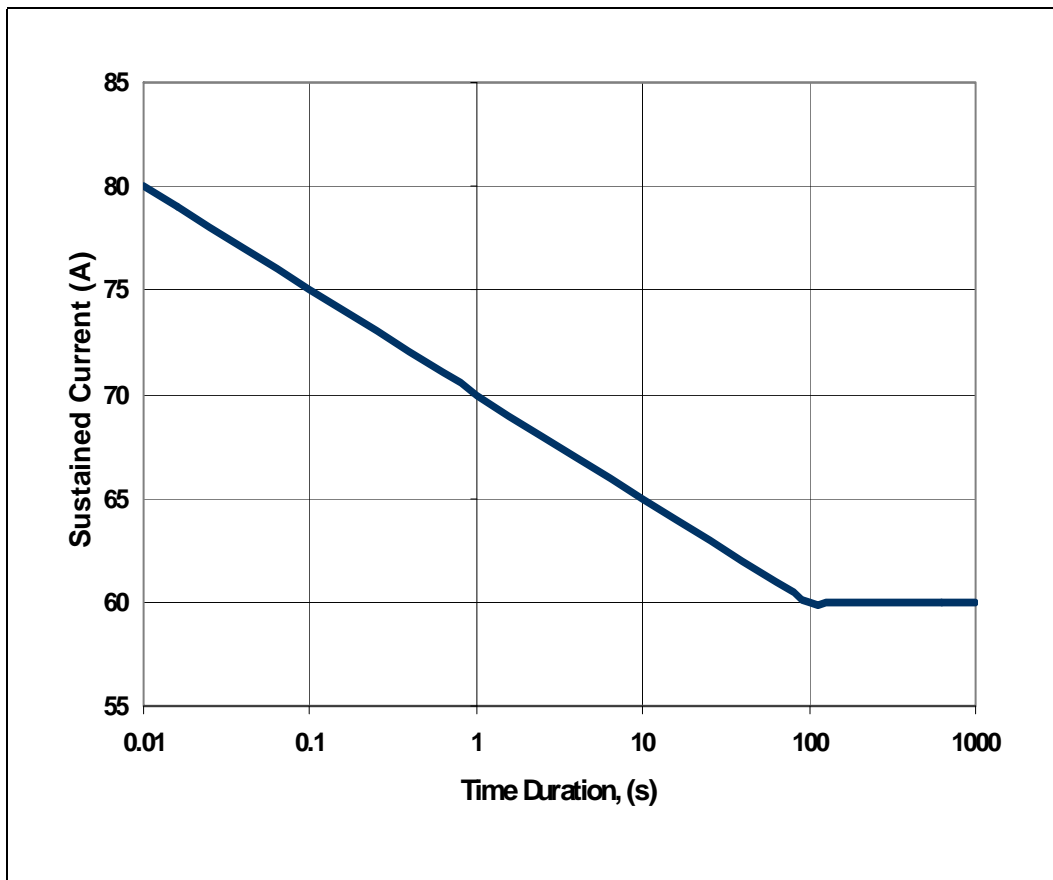


**Notes:**

1. Processor or voltage regulator thermal protection circuitry should not trip for load currents greater than  $I_{CC\_TDC}$ .
2. Not 100% tested. Specified by design characterization.

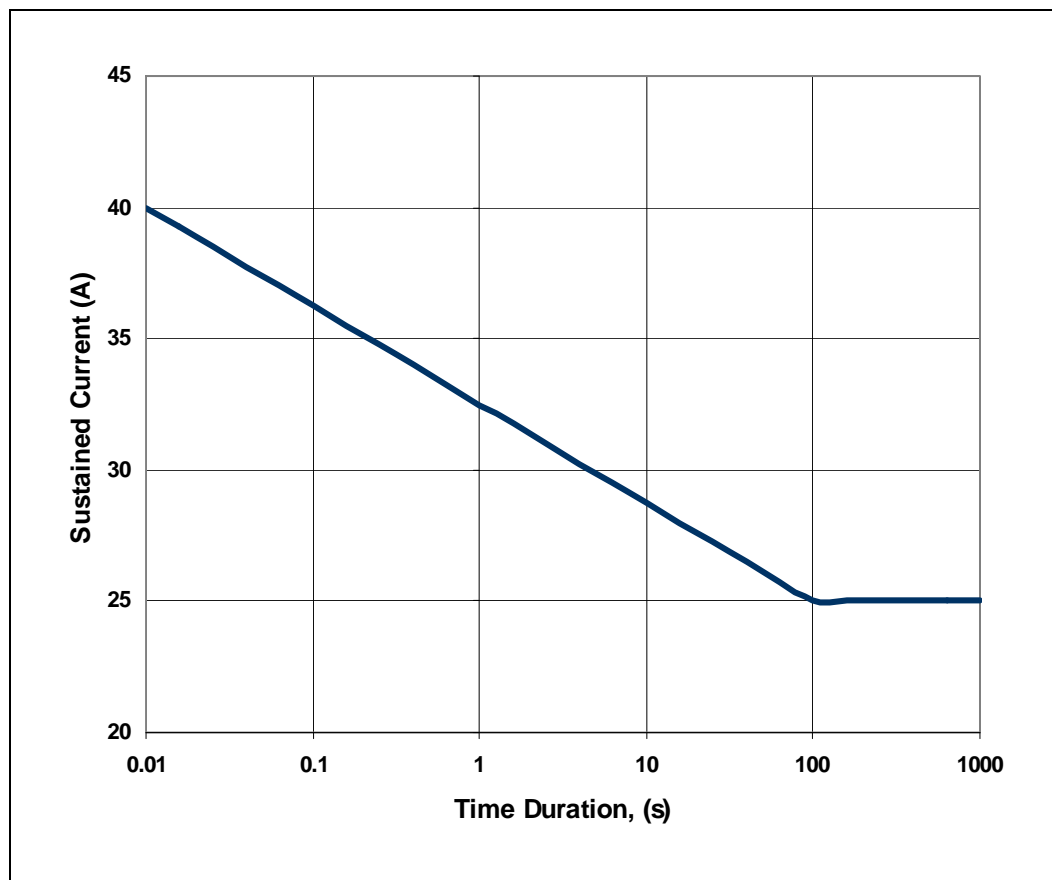


Figure 2-8. Load Current Versus Time (60W TDP Processor)<sup>1,2</sup>



**Notes:**

1. Processor or voltage regulator thermal protection circuitry should not trip for load currents greater than  $I_{CC\_TDC}$ .
2. Not 100% tested. Specified by design characterization.

Figure 2-9. Load Current Versus Time (38W TDP Processor)<sup>1,2</sup>**Notes:**

- Processor or voltage regulator thermal protection circuitry should not trip for load currents greater than  $I_{CC\_TDC}$ .
- Not 100% tested. Specified by design characterization.

Table 2-11.  $V_{TT}$  Static and Transient Tolerance (Sheet 1 of 2)

$I_{TT}$ (A)	$V_{TT\_Max}$ (V)	$V_{TT\_Typ}$ (V)	$V_{TT\_Min}$ (V)	Notes <sup>1,2,3,4</sup>
0	$V_{TT\_VID} + 0.0315$	$V_{TT\_VID} - 0.0000$	$V_{TT\_VID} - 0.0315$	
1	$V_{TT\_VID} + 0.0255$	$V_{TT\_VID} - 0.0060$	$V_{TT\_VID} - 0.0375$	
2	$V_{TT\_VID} + 0.0195$	$V_{TT\_VID} - 0.0120$	$V_{TT\_VID} - 0.0435$	
3	$V_{TT\_VID} + 0.0135$	$V_{TT\_VID} - 0.0180$	$V_{TT\_VID} - 0.0495$	
4	$V_{TT\_VID} + 0.0075$	$V_{TT\_VID} - 0.0240$	$V_{TT\_VID} - 0.0555$	
5	$V_{TT\_VID} + 0.0015$	$V_{TT\_VID} - 0.0300$	$V_{TT\_VID} - 0.0615$	
6	$V_{TT\_VID} - 0.0045$	$V_{TT\_VID} - 0.0360$	$V_{TT\_VID} - 0.0675$	
7	$V_{TT\_VID} - 0.0105$	$V_{TT\_VID} - 0.0420$	$V_{TT\_VID} - 0.0735$	
8	$V_{TT\_VID} - 0.0165$	$V_{TT\_VID} - 0.0480$	$V_{TT\_VID} - 0.0795$	
9	$V_{TT\_VID} - 0.0225$	$V_{TT\_VID} - 0.0540$	$V_{TT\_VID} - 0.0855$	
10	$V_{TT\_VID} - 0.0285$	$V_{TT\_VID} - 0.0600$	$V_{TT\_VID} - 0.0915$	
11	$V_{TT\_VID} - 0.0345$	$V_{TT\_VID} - 0.0660$	$V_{TT\_VID} - 0.0975$	
12	$V_{TT\_VID} - 0.0405$	$V_{TT\_VID} - 0.0720$	$V_{TT\_VID} - 0.1035$	



Table 2-11.  $V_{TT}$  Static and Transient Tolerance (Sheet 2 of 2)

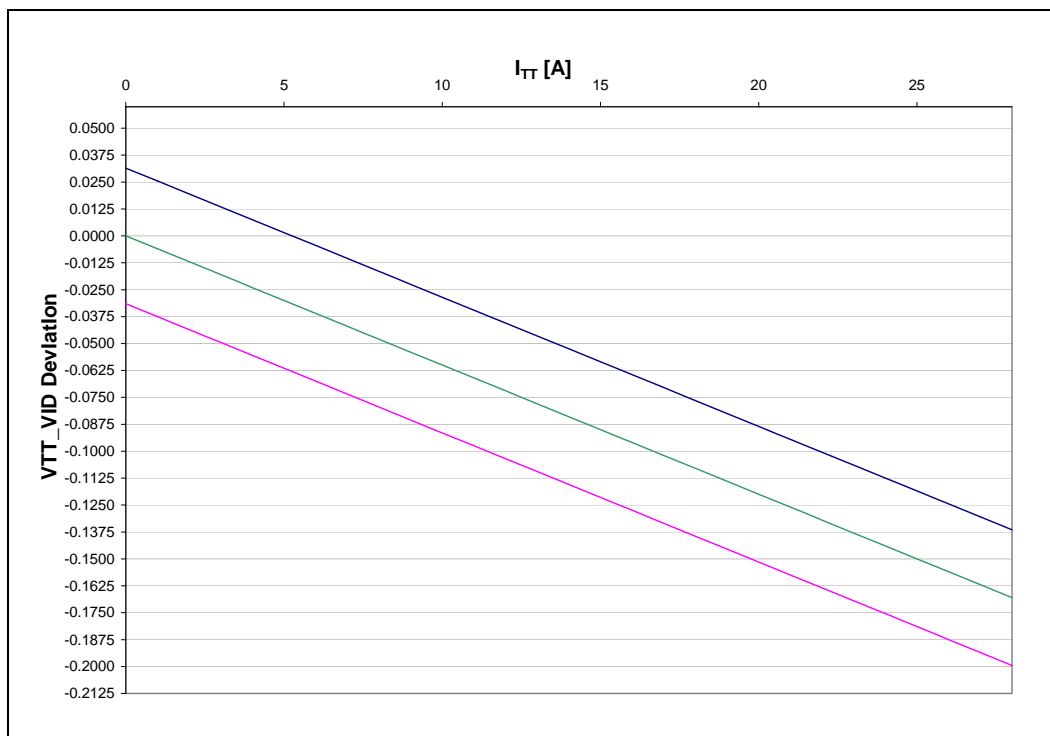
$I_{TT}$ (A)	$V_{TT\_Max}$ (V)	$V_{TT\_Typ}$ (V)	$V_{TT\_Min}$ (V)	Notes <sup>1,2,3,4</sup>
13	VTT_VID - 0.0465	VTT_VID - 0.0780	VTT_VID - 0.1095	
14	VTT_VID - 0.0525	VTT_VID - 0.0840	VTT_VID - 0.1155	
15	VTT_VID - 0.0585	VTT_VID - 0.0900	VTT_VID - 0.1215	
16	VTT_VID - 0.0645	VTT_VID - 0.0960	VTT_VID - 0.1275	
17	VTT_VID - 0.0705	VTT_VID - 0.1020	VTT_VID - 0.1335	
18	VTT_VID - 0.0765	VTT_VID - 0.1080	VTT_VID - 0.1395	
19	VTT_VID - 0.0825	VTT_VID - 0.1140	VTT_VID - 0.1455	
20	VTT_VID - 0.0885	VTT_VID - 0.1200	VTT_VID - 0.1515	
21	VTT_VID - 0.0945	VTT_VID - 0.1260	VTT_VID - 0.1575	
22	VTT_VID - 0.1005	VTT_VID - 0.1320	VTT_VID - 0.1635	
23	VTT_VID - 0.1065	VTT_VID - 0.1380	VTT_VID - 0.1695	
24	VTT_VID - 0.1125	VTT_VID - 0.1440	VTT_VID - 0.1755	
25	VTT_VID - 0.1185	VTT_VID - 0.1500	VTT_VID - 0.1815	
26	VTT_VID - 0.1245	VTT_VID - 0.1560	VTT_VID - 0.1875	
27	VTT_VID - 0.1305	VTT_VID - 0.1620	VTT_VID - 0.1935	
28	VTT_VID - 0.1365	VTT_VID - 0.1680	VTT_VID - 0.1995	

**Note:**

1.  $I_{TT}$  listed in this table is the sum of  $I_{TTA}$  and  $I_{TTD}$ .
2. This table is intended to aid in reading discrete points on [Figure 2-10](#).
3. The  $V_{TT\_MIN}$  and  $V_{TT\_MAX}$  loadlines represent static and transient limits. Each is characterized by a  $\pm 31.5$  mV offset from  $V_{TT\_TYP}$ .
4. The loadlines specify voltage limits at the die measured at the VTTD\_SENSE and VSS\_SENSE\_VTTD lands. Voltage regulation feedback for regulator circuits must also be taken from VTTD\_SENSE and VSS\_SENSE\_VTTD lands.



Figure 2-10.  $V_{TT}$  Static and Transient Tolerance Loadlines



**Notes:**

1. The  $V_{TT\_MIN}$  and  $V_{TT\_MAX}$  loadlines represent static and transient limits. Each is characterized by a  $\pm 31.5$  mV offset from  $V_{TT\_TYP}$ .
2. Refer to Table 2-4 for processor  $V_{TT\_VID}$  information.
3. Refer to Table 2-11 for  $V_{TT}$  Static and Transient Tolerance.

Table 2-12. DDR3 Signal Group DC Specifications (Sheet 1 of 2)

Symbol	Parameter	Min	Typ	Max	Units	Notes <sup>1</sup>
$V_{IL}$	Input Low Voltage			$0.43 * V_{DDQ}$	V	2,
$V_{IH}$	Input High Voltage	$0.57 * V_{DDQ}$			V	3, 4
$V_{OL}$	Output Low Voltage		$(V_{DDQ} / 2) * (R_{ON} / (R_{ON} + R_{VTT\_TERM}))$		V	6
$V_{OH}$	Output High Voltage		$V_{DDQ} - ((V_{DDQ} / 2) * (R_{ON} / (R_{ON} + R_{VTT\_TERM})))$		V	4,6
$R_{ON}$	DDR3 Clock Buffer On Resistance	21		31	$\Omega$	5
$R_{ON}$	DDR3 Command Buffer On Resistance	16		24	$\Omega$	5
$R_{ON}$	DDR3 Reset Buffer On Resistance	25		75	$\Omega$	5
$R_{ON}$	DDR3 Control Buffer On Resistance	21		31	$\Omega$	5
$R_{ON}$	DDR3 Data Buffer On Resistance	21		31	$\Omega$	5
Data ODT	On-Die Termination for Data Signals	45 90		55 110	$\Omega$	7



Table 2-12. DDR3 Signal Group DC Specifications (Sheet 2 of 2)

Symbol	Parameter	Min	Typ	Max	Units	Notes <sup>1</sup>
ParErr ODT	On-Die Termination for Parity Error bits	60		80	Ω	
I <sub>LI</sub>	Input Leakage Current	N/A	N/A	± 500	mA	
DDR_COMP0	COMP Resistance	99	100	101	Ω	8
DDR_COMP1	COMP Resistance	24.65	24.9	25.15	Ω	8
DDR_COMP2	COMP Resistance	128.7	130	131.3	Ω	8

**Notes:**

1. Unless otherwise noted, all specifications in this table apply to all processor frequencies.
2. V<sub>IL</sub> is the maximum voltage level at a receiving agent that will be interpreted as a logical low value.
3. V<sub>IH</sub> is the minimum voltage level at a receiving agent that will be interpreted as a logical high value.
4. V<sub>IH</sub> and V<sub>OH</sub> may experience excursions above V<sub>DDQ</sub>.
5. This is the pull down driver resistance. Refer to processor signal integrity models for I/V characteristics.
6. R<sub>VTT\_TERM</sub> is the termination on the DIMM and not controlled by the Intel Xeon Processor 5500 Series. Please refer to the applicable DIMM datasheet.
7. The minimum and maximum values for these signals are programmable by BIOS to one of the pairs.
8. COMP resistance must be provided on the system board with 1% resistors. DDR\_COMP[2:0] resistors are to V<sub>SS</sub>.

Table 2-13. PECl DC Electrical Limits

Symbol	Definition and Conditions	Min	Max	Units	Notes <sup>1</sup>
V <sub>In</sub>	Input Voltage Range	-0.150	V <sub>TTD</sub> + 0.150	V	
V <sub>Hysteresis</sub>	Hysteresis	0.100 * V <sub>TTD</sub>		V	
V <sub>N</sub>	Negative-edge threshold voltage	0.275 * V <sub>TTD</sub>	0.500 * V <sub>TTD</sub>	V	2,6
V <sub>P</sub>	Positive-edge threshold voltage	0.550 * V <sub>TTD</sub>	0.725 * V <sub>TTD</sub>	V	2,6
R <sub>Pullup</sub>	Pullup Resistance (V <sub>OH</sub> = 0.75 * V <sub>TTD</sub> )	N/A	50	Ω	
I <sub>Leak+</sub>	High impedance state leakage to V <sub>TTD</sub> (V <sub>leak</sub> = V <sub>OL</sub> )	N/A	50	μA	3
I <sub>Leak-</sub>	High impedance leakage to GND (V <sub>leak</sub> = V <sub>OH</sub> )	N/A	25	μA	3
C <sub>Bus</sub>	Bus capacitance per node	N/A	10	pF	4,5
V <sub>Noise</sub>	Signal noise immunity above 300 MHz	0.100 * V <sub>TTD</sub>	N/A	V <sub>p-p</sub>	

**Note:**

1. V<sub>TTD</sub> supplies the PECl interface. PECl behavior does not affect V<sub>TTD</sub> min/max specifications.
2. It is expected that the PECl driver will take into account, the variance in the receiver input thresholds and consequently, be able to drive its output within safe limits (-0.150 V to 0.275\*V<sub>TTD</sub> for the low level and 0.725\*V<sub>TTD</sub> to V<sub>TTD</sub>+0.150 for the high level).
3. The leakage specification applies to powered devices on the PECl bus.
4. One node is counted for each client and one node for the system host. Extended trace lengths might appear as additional nodes.
5. Excessive capacitive loading on the PECl line may slow down the signal rise/fall times and consequently limit the maximum bit rate at which the interface can operate.
6. Please refer to [Figure 2-2](#) for further information.





Table 2-14. RESET# Signal DC Specifications

Symbol	Parameter	Min	Typ	Max	Units	Notes <sup>1</sup>
V <sub>IL</sub>	Input Low Voltage			0.60 × V <sub>TTA</sub>	V	2,3
V <sub>IH</sub>	Input High Voltage	0.70 × V <sub>TTA</sub>			V	2,3,5
R <sub>ON</sub>	Processor Sideband Buffer On Resistance	10		18	Ω	
I <sub>LI</sub>	Input Leakage Current			± 200	μA	4

**Notes:**

1. Unless otherwise noted, all specifications in this table apply to all processor frequencies.
2. The V<sub>TTA</sub> referred to in these specifications refers to instantaneous V<sub>TTA</sub>.
3. Based on a test load of 50 Ω to V<sub>TTA</sub>.
4. For V<sub>IN</sub> between 0 V and V<sub>TTA</sub>. Measured when the driver is tristated.
5. V<sub>IH</sub> and V<sub>OH</sub> may experience excursions above V<sub>TT</sub>.

Table 2-15. TAP Signal Group DC Specifications

Symbol	Parameter	Min	Typ	Max	Units	Notes <sup>1</sup>
V <sub>IL</sub>	Input Low Voltage			0.40 × V <sub>TTA</sub>	V	2,3
V <sub>IH</sub>	Input High Voltage	0.60 × V <sub>TTA</sub>			V	2,3,5
V <sub>OL</sub>	Output Low Voltage			$\frac{V_{TTA} \times R_{ON}}{R_{ON} + R_{SYS\_TERM}}$	V	2,6
V <sub>OH</sub>	Output High Voltage	V <sub>TTA</sub>			V	2,5
R <sub>ON</sub>	Processor Sideband Buffer On Resistance	10		18	Ω	
I <sub>LI</sub>	Input Leakage Current			± 200	μA	4

**Notes:**

1. Unless otherwise noted, all specifications in this table apply to all processor frequencies.
2. The V<sub>TTA</sub> referred to in these specifications refers to instantaneous V<sub>TTA</sub>.
3. Based on a test load of 50 Ω to V<sub>TTA</sub>.
4. For V<sub>IN</sub> between 0 V and V<sub>TTA</sub>. Measured when the driver is tristated.
5. V<sub>IH</sub> and V<sub>OH</sub> may experience excursions above V<sub>TT</sub>.
6. R<sub>SYS\_TERM</sub> is the termination on the system and is not controlled by the Intel Xeon processor 5500 series

Table 2-16. PWRGOOD Signal Group DC Specifications

Symbol	Parameter	Min	Typ	Max	Units	Notes <sup>1</sup>
V <sub>IL</sub>	Input Low Voltage for V <sub>TPWRGOOD</sub> and V <sub>CCPWRGOOD</sub> signals			0.25 × V <sub>TTA</sub>	V	2,3
V <sub>IL</sub>	Input Low Voltage for V <sub>DDPWRGOOD</sub> signal			0.29	V	3
V <sub>IH</sub>	Input High Voltage for V <sub>TPWRGOOD</sub> and V <sub>CCPWRGOOD</sub> signals	0.75 × V <sub>TTA</sub>			V	2,3
V <sub>IH</sub>	Input High Voltage for V <sub>DDPWRGOOD</sub> signal	0.87			V	3
ODT	On-Die Termination	45		55		
R <sub>ON</sub>	Processor Sideband Buffer On Resistance	10		18	Ω	
I <sub>LI</sub>	Input Leakage Current			± 200	μA	4

**Notes:**

1. Unless otherwise noted, all specifications in this table apply to all processor frequencies.
2. The V<sub>TTA</sub> referred to in these specifications refers to instantaneous V<sub>TTA</sub>.
3. Based on a test load of 50 Ω to V<sub>TTA</sub>.
4. For V<sub>IN</sub> between 0 V and V<sub>TTA</sub>. Measured when the driver is tristated.
5. V<sub>IH</sub> and V<sub>OH</sub> may experience excursions above V<sub>TT</sub>.



Table 2-17. Control Sideband Signal Group DC Specifications

Symbol	Parameter	Min	Typ	Max	Units	Notes <sup>1</sup>
V <sub>IL</sub>	Input Low Voltage			0.64 * V <sub>TTA</sub>	V	2,3
V <sub>IL</sub>	Input Low Voltage for PECl_ID signal			0.15 * V <sub>TTA</sub>	V	2,3
V <sub>IH</sub>	Input High Voltage	0.76 * V <sub>TTA</sub>			V	2,3
V <sub>IH</sub>	Input High Voltage for PECl_ID signal	0.85 * V <sub>TTA</sub>			V	2,3
V <sub>OL</sub>	Output Low Voltage			$\frac{V_{TTA} * R_{ON}}{(R_{ON} + R_{SYS\_TERM})}$	V	2,4
V <sub>OH</sub>	Output High Voltage	V <sub>TTA</sub>			V	2
ODT	On-Die Termination	45		55		5
R <sub>ON</sub>	Processor Sideband Buffer On Resistance	10		18	Ω	
R <sub>ON</sub>	Buffer On Resistance for VID[7:0]		100		Ω	
I <sub>LI</sub>	Input Leakage Current			± 200	μA	6
I <sub>LI</sub>	Input Leakage Current for DDR_THERM# signal			± 50	μA	6
COMPO	COMP Resistance	49.4	49.9	50.4	Ω	7

**Notes:**

1. Unless otherwise noted, all specifications in this table apply to all processor frequencies.
2. The V<sub>TTA</sub> referred to in these specifications refers to instantaneous V<sub>TTA</sub>.
3. Based on a test load of 50 Ω to V<sub>TTA</sub>.
4. R<sub>SYS\_TERM</sub> is the termination on the system and is not controlled by the Intel Xeon processor 5500 series.
5. Applies to all Processor Sideband signals, unless otherwise mentioned in Table 2-5.
6. For V<sub>IN</sub> between 0 V and V<sub>TTA</sub>. Measured when the driver is tristated.
7. COMP resistance must be provided on the system board with 1% resistors. See the applicable platform design guide for implementation details. COMPO resistors are to VSS.

**§**



# 3 Package Mechanical Specifications

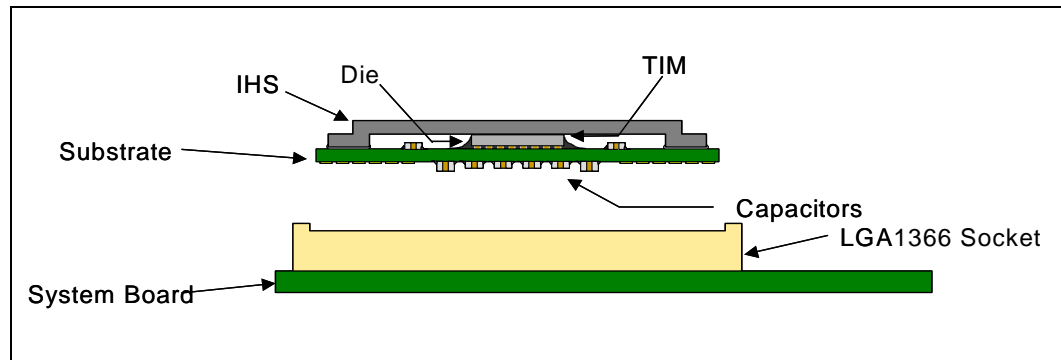
## 3.1 Package Mechanical Specifications

The processor is packaged in a Flip-Chip Land Grid Array (FC-LGA6) package that interfaces with the motherboard via an LGA1366 socket. The package consists of a processor mounted on a substrate land-carrier. An integrated heat spreader (IHS) is attached to the package substrate and core and serves as the mating surface for processor component thermal solutions, such as a heatsink. [Figure 3-1](#) shows a sketch of the processor package components and how they are assembled together. Refer to the Processors and Socket in the *Intel® Xeon® Processor 5500/5600 Series Thermal/Mechanical Design Guide* for complete details on the LGA1366 socket.

The package components shown in [Figure 3-1](#) include the following:

1. Integrated Heat Spreader (IHS)
2. Thermal Interface Material (TIM)
3. Processor core (die)
4. Package substrate
5. Capacitors

**Figure 3-1. Processor Package Assembly Sketch**



**Note:**

1. Socket and motherboard are included for reference and are not part of processor package.



### 3.1.1 Package Mechanical Drawing

The package mechanical drawings are shown in [Figure 3-2](#) and [Figure 3-3](#). The drawings include dimensions necessary to design a thermal solution for the processor. These dimensions include:

1. Package reference with tolerances (total height, length, width, and so forth)
2. IHS parallelism and tilt
3. Land dimensions
4. Top-side and back-side component keep-out dimensions
5. Reference datums
6. All drawing dimensions are in mm.
7. Guidelines on potential IHS flatness variation with socket load plate actuation and installation of the cooling solution is available in the TMDG.

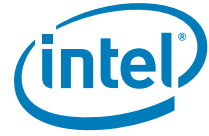


Figure 3-2. Processor Package Drawing (Sheet 1 of 2)

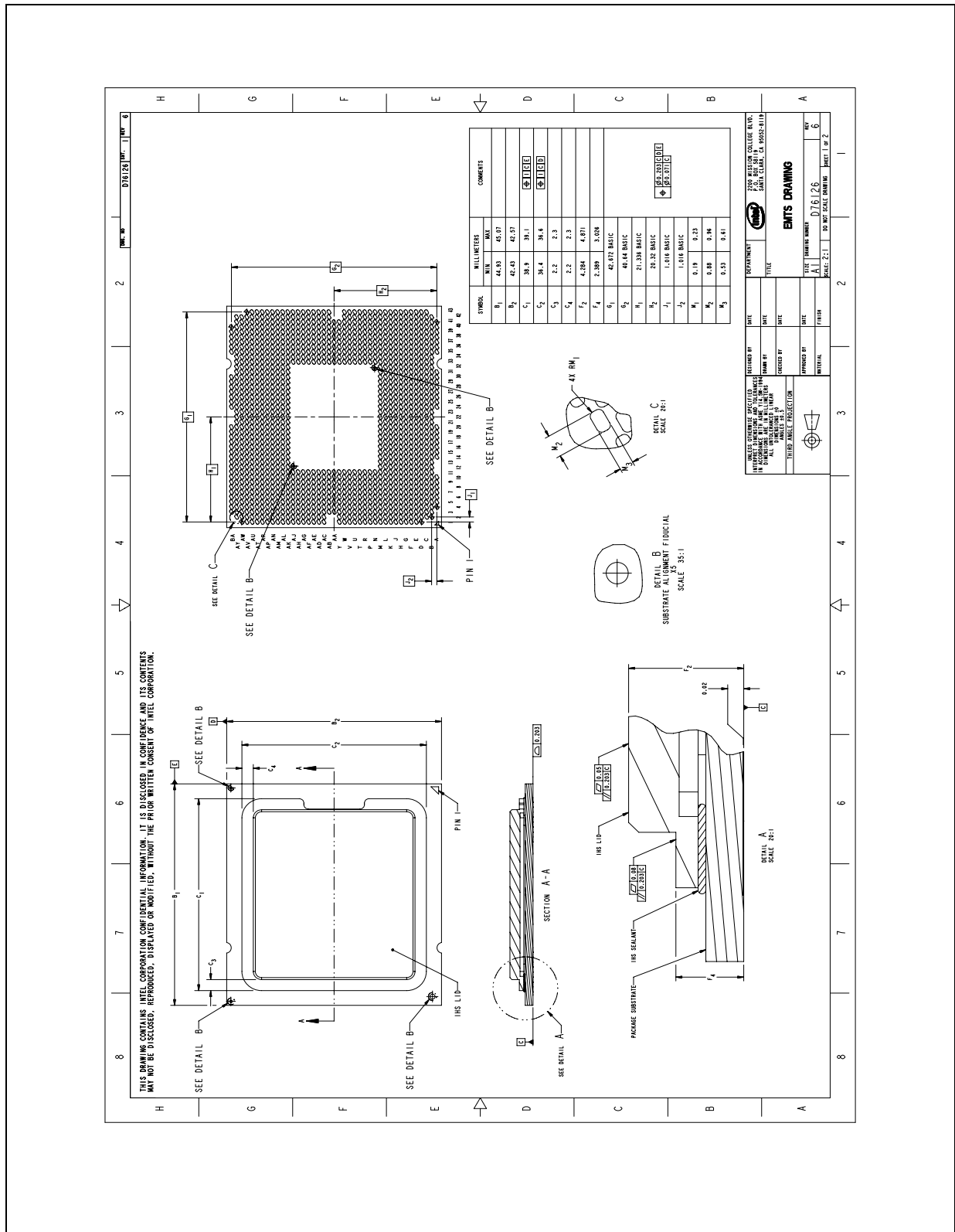
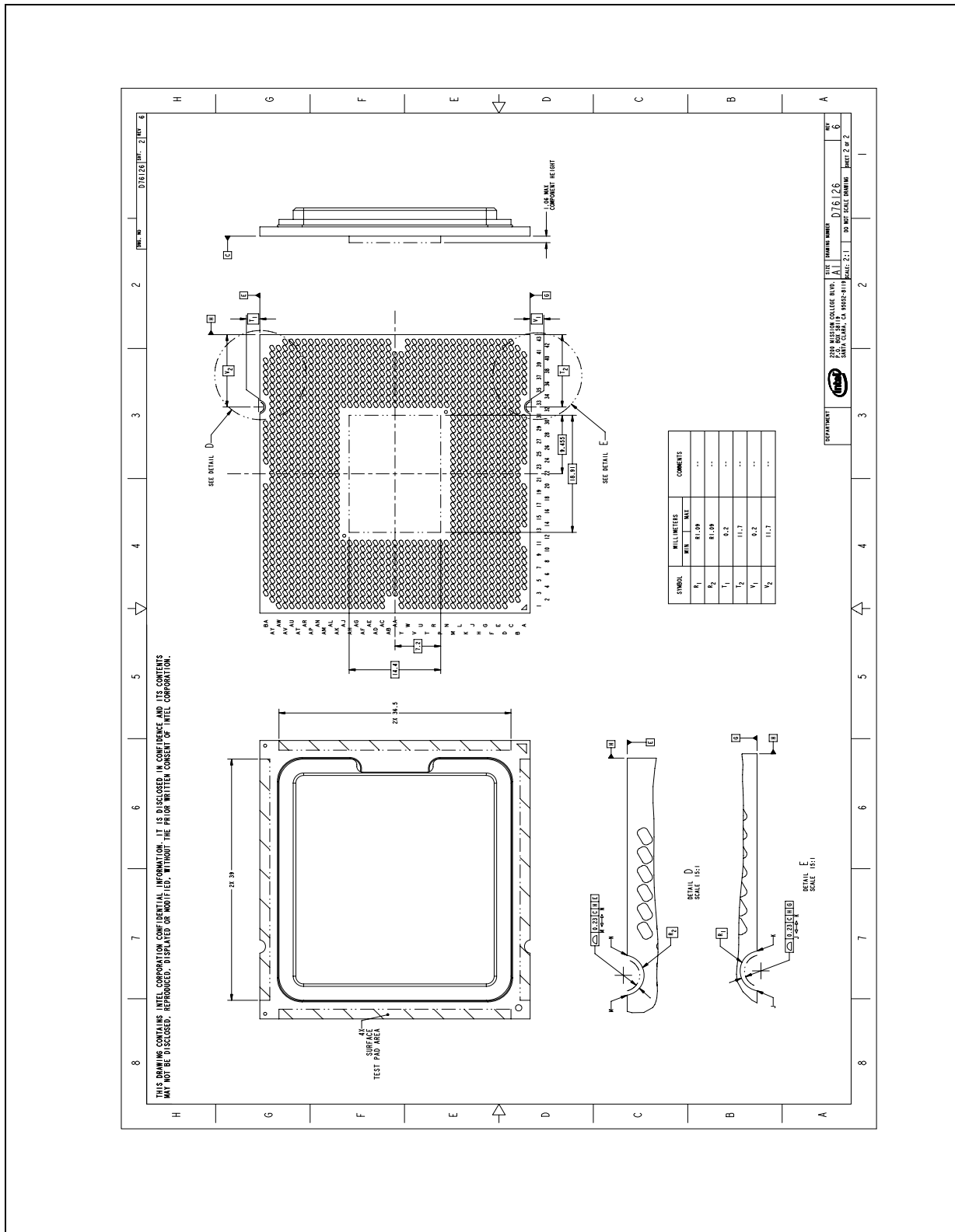


Figure 3-3. Processor Package Drawing (Sheet 2 of 2)





### 3.1.2 Processor Component Keep-Out Zones

The processor may contain components on the substrate that define component keep-out zone requirements. A thermal and mechanical solution design must not intrude into the required keep-out zones. Do not contact the Test Pad Area with conductive material. Decoupling capacitors are typically mounted to either the topside or land-side of the package substrate. See [Figure 3-2](#) and [Figure 3-3](#) for keep-out zones. The location and quantity of package capacitors may change due to manufacturing efficiencies but will remain within the component keep-in.

### 3.1.3 Package Loading Specifications

[Table 3-1](#) provides load specifications for the processor package. These maximum limits should not be exceeded during heatsink assembly, shipping conditions, or standard use condition. Exceeding these limits during test may result in component failure. The processor substrate should not be used as a mechanical reference or load-bearing surface for thermal solutions.

**Table 3-1. Processor Loading Specifications**

Parameter	Maximum	Notes
Static Compressive Load	890 N [200 lbf]	1, 2, 3, 5
Dynamic Compressive Load	1779 N [400 lbf] [max static compressive + dynamic load]	1, 3, 4, 5

**Notes:**

1. These specifications apply to uniform compressive loading in a direction normal to the processor IHS.
2. This is the maximum static force that can be applied by the heatsink and Independent Loading Mechanism (ILM).
3. These specifications are based on limited testing for design characterization. Loading limits are for the package constrained by the limits of the processor socket.
4. Dynamic loading is defined as an 11 ms duration average load superimposed on the static load requirement.
5. See *Intel® Xeon® Processor 5500/5600 Series Thermal/Mechanical Design Guide* for minimum socket load to engage processor within socket.

### 3.1.4 Package Handling Guidelines

[Table 3-2](#) includes a list of guidelines on package handling in terms of recommended maximum loading on the processor IHS relative to a fixed substrate. These package handling loads may be experienced during heatsink removal.

**Table 3-2. Package Handling Guidelines**

Parameter	Maximum Recommended	Notes
Shear	70 lbs	-
Tensile	25 lbs	-
Torque	35 in.lbs	-

### 3.1.5 Package Insertion Specifications

The processor can be inserted into and removed from a LGA1366 socket 15 times. The socket should meet the LGA1366 requirements detailed in the TMDG.

### 3.1.6 Processor Mass Specification

The typical mass of the processor is 35 grams. This mass [weight] includes all the components that are included in the package.

### 3.1.7 Processor Materials

Table 3-3 lists some of the package components and associated materials.

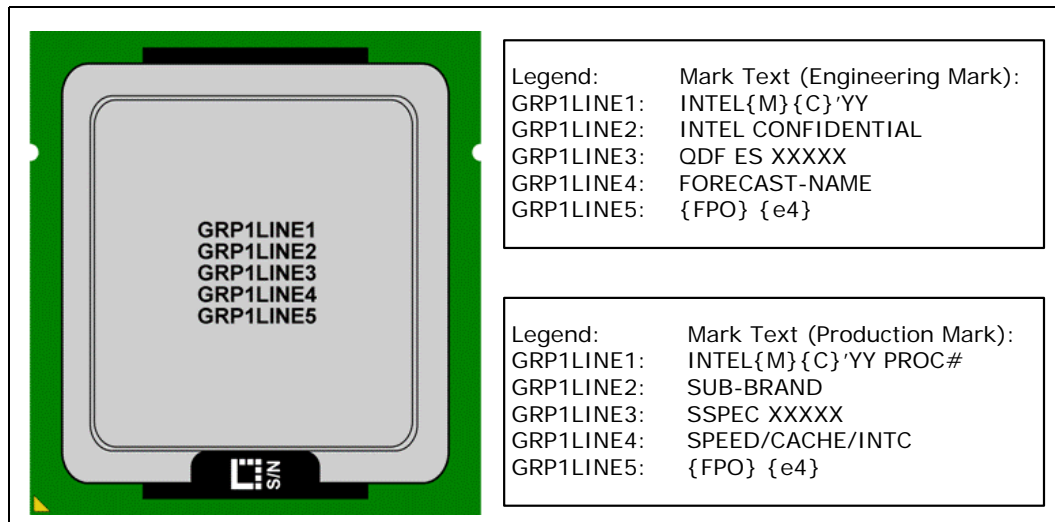
Table 3-3. Processor Materials

Component	Material
Integrated Heat Spreader (IHS)	Nickel Plated Copper
Substrate	Fiber Reinforced Resin
Substrate Lands	Gold Plated Copper

### 3.1.8 Processor Markings

Figure 3-4 shows the topside markings on the processor. This diagram is to aid in the identification of the processor.

Figure 3-4. Processor Top-Side Markings



### 3.1.9 Processor Land Coordinates

Please refer to Figure 3-3 which shows the bottom view of the processor land coordinates. The coordinates are referred to throughout the document to identify processor lands.

§





# 4 Land Listing

## 4.1 Intel® Xeon® Processors 5500 Series Pin Assignments

This section provides sorted land list in Table 4-1 and Table 4-2. Table 4-1 is a listing of all processor lands ordered alphabetically by land name. Table 4-2 is a listing of all processor lands ordered by land number.

**Note:** A land name prefixed with a FC denotes a Future Connect land.

### 4.1.1 Land Listing by Land Name

Table 4-1. Land Listing by Land Name (Sheet 1 of 36)

Land Name	Land No.	Buffer Type	Direction
BCLK_DN	AH35	CMOS	I
BCLK_DP	AJ35	CMOS	I
BCLK_ITP_DN	AA4	CMOS	O
BCLK_ITP_DP	AA5	CMOS	O
BPM#[0]	B3	GTL	I/O
BPM#[1]	A5	GTL	I/O
BPM#[2]	C2	GTL	I/O
BPM#[3]	B4	GTL	I/O
BPM#[4]	D1	GTL	I/O
BPM#[5]	C3	GTL	I/O
BPM#[6]	D2	GTL	I/O
BPM#[7]	E2	GTL	I/O
CAT_ERR#	AC37	GTL	I/O
COMPO	AB41	Analog	
QPI0_CLKRX_DN	AR42	QPI	I
QPI0_CLKRX_DP	AR41	QPI	I
QPI0_CLKTX_DN	AF42	QPI	O
QPI0_CLKTX_DP	AG42	QPI	O
QPI0_COMP	AL43	Analog	
QPI0_DRX_DN[0]	AU37	QPI	I
QPI0_DRX_DN[1]	AV38	QPI	I
QPI0_DRX_DN[10]	AT42	QPI	I
QPI0_DRX_DN[11]	AR43	QPI	I
QPI0_DRX_DN[12]	AR40	QPI	I
QPI0_DRX_DN[13]	AN42	QPI	I
QPI0_DRX_DN[14]	AM43	QPI	I
QPI0_DRX_DN[15]	AM40	QPI	I

Table 4-1. Land Listing by Land Name (Sheet 2 of 36)

Land Name	Land No.	Buffer Type	Direction
QPI0_DRX_DN[16]	AM41	QPI	I
QPI0_DRX_DN[17]	AP40	QPI	I
QPI0_DRX_DN[18]	AP39	QPI	I
QPI0_DRX_DN[19]	AR38	QPI	I
QPI0_DRX_DN[2]	AV37	QPI	I
QPI0_DRX_DN[3]	AY36	QPI	I
QPI0_DRX_DN[4]	BA37	QPI	I
QPI0_DRX_DN[5]	AW38	QPI	I
QPI0_DRX_DN[6]	AY38	QPI	I
QPI0_DRX_DN[7]	AT39	QPI	I
QPI0_DRX_DN[8]	AV40	QPI	I
QPI0_DRX_DN[9]	AU41	QPI	I
QPI0_DRX_DP[0]	AT37	QPI	I
QPI0_DRX_DP[1]	AU38	QPI	I
QPI0_DRX_DP[10]	AU42	QPI	I
QPI0_DRX_DP[11]	AT43	QPI	I
QPI0_DRX_DP[12]	AT40	QPI	I
QPI0_DRX_DP[13]	AP42	QPI	I
QPI0_DRX_DP[14]	AN43	QPI	I
QPI0_DRX_DP[15]	AN40	QPI	I
QPI0_DRX_DP[16]	AM42	QPI	I
QPI0_DRX_DP[17]	AP41	QPI	I
QPI0_DRX_DP[18]	AN39	QPI	I
QPI0_DRX_DP[19]	AP38	QPI	I
QPI0_DRX_DP[2]	AV36	QPI	I
QPI0_DRX_DP[3]	AW36	QPI	I
QPI0_DRX_DP[4]	BA36	QPI	I



**Table 4-1. Land Listing by Land Name (Sheet 3 of 36)**

Land Name	Land No.	Buffer Type	Direction
QPIO_DRX_DP[5]	AW37	QPI	I
QPIO_DRX_DP[6]	BA38	QPI	I
QPIO_DRX_DP[7]	AU39	QPI	I
QPIO_DRX_DP[8]	AW40	QPI	I
QPIO_DRX_DP[9]	AU40	QPI	I
QPIO_DTX_DN[0]	AH38	QPI	O
QPIO_DTX_DN[1]	AG39	QPI	O
QPIO_DTX_DN[10]	AE43	QPI	O
QPIO_DTX_DN[11]	AE41	QPI	O
QPIO_DTX_DN[12]	AC42	QPI	O
QPIO_DTX_DN[13]	AB43	QPI	O
QPIO_DTX_DN[14]	AD39	QPI	O
QPIO_DTX_DN[15]	AC40	QPI	O
QPIO_DTX_DN[16]	AC38	QPI	O
QPIO_DTX_DN[17]	AB38	QPI	O
QPIO_DTX_DN[18]	AE38	QPI	O
QPIO_DTX_DN[19]	AF40	QPI	O
QPIO_DTX_DN[2]	AK38	QPI	O
QPIO_DTX_DN[3]	AJ39	QPI	O
QPIO_DTX_DN[4]	AJ40	QPI	O
QPIO_DTX_DN[5]	AK41	QPI	O
QPIO_DTX_DN[6]	AH42	QPI	O
QPIO_DTX_DN[7]	AJ42	QPI	O
QPIO_DTX_DN[8]	AH43	QPI	O
QPIO_DTX_DN[9]	AG41	QPI	O
QPIO_DTX_DP[0]	AG38	QPI	O
QPIO_DTX_DP[1]	AF39	QPI	O
QPIO_DTX_DP[10]	AF43	QPI	O
QPIO_DTX_DP[11]	AE42	QPI	O
QPIO_DTX_DP[12]	AD42	QPI	O
QPIO_DTX_DP[13]	AC43	QPI	O
QPIO_DTX_DP[14]	AD40	QPI	O
QPIO_DTX_DP[15]	AC41	QPI	O
QPIO_DTX_DP[16]	AC39	QPI	O
QPIO_DTX_DP[17]	AB39	QPI	O
QPIO_DTX_DP[18]	AD38	QPI	O
QPIO_DTX_DP[19]	AE40	QPI	O
QPIO_DTX_DP[2]	AK37	QPI	O
QPIO_DTX_DP[3]	AJ38	QPI	O
QPIO_DTX_DP[4]	AH40	QPI	O

**Table 4-1. Land Listing by Land Name (Sheet 4 of 36)**

Land Name	Land No.	Buffer Type	Direction
QPIO_DTX_DP[5]	AK40	QPI	O
QPIO_DTX_DP[6]	AH41	QPI	O
QPIO_DTX_DP[7]	AK42	QPI	O
QPIO_DTX_DP[8]	AJ43	QPI	O
QPIO_DTX_DP[9]	AG40	QPI	O
QPI1_CLKRX_DN	AR6	QPI	I
QPI1_CLKRX_DP	AT6	QPI	I
QPI1_CLKTX_DN	AE6	QPI	O
QPI1_CLKTX_DP	AF6	QPI	O
QPI1_COMP	AL6	Analog	
QPI1_DRX_DN[0]	AV8	QPI	I
QPI1_DRX_DN[1]	AW7	QPI	I
QPI1_DRX_DN[10]	AR1	QPI	I
QPI1_DRX_DN[11]	AR5	QPI	I
QPI1_DRX_DN[12]	AN2	QPI	I
QPI1_DRX_DN[13]	AM1	QPI	I
QPI1_DRX_DN[14]	AM3	QPI	I
QPI1_DRX_DN[15]	AP4	QPI	I
QPI1_DRX_DN[16]	AN4	QPI	I
QPI1_DRX_DN[17]	AN6	QPI	I
QPI1_DRX_DN[18]	AM7	QPI	I
QPI1_DRX_DN[19]	AL8	QPI	I
QPI1_DRX_DN[2]	BA8	QPI	I
QPI1_DRX_DN[3]	AW5	QPI	I
QPI1_DRX_DN[4]	BA6	QPI	I
QPI1_DRX_DN[5]	AY5	QPI	I
QPI1_DRX_DN[6]	AU6	QPI	I
QPI1_DRX_DN[7]	AW3	QPI	I
QPI1_DRX_DN[8]	AU3	QPI	I
QPI1_DRX_DN[9]	AT2	QPI	I
QPI1_DRX_DP[0]	AU8	QPI	I
QPI1_DRX_DP[1]	AV7	QPI	I
QPI1_DRX_DP[10]	AT1	QPI	I
QPI1_DRX_DP[11]	AR4	QPI	I
QPI1_DRX_DP[12]	AP2	QPI	I
QPI1_DRX_DP[13]	AN1	QPI	I
QPI1_DRX_DP[14]	AM2	QPI	I
QPI1_DRX_DP[15]	AP3	QPI	I
QPI1_DRX_DP[16]	AM4	QPI	I
QPI1_DRX_DP[17]	AN5	QPI	I



**Table 4-1. Land Listing by Land Name  
(Sheet 5 of 36)**

Land Name	Land No.	Buffer Type	Direction
QPI1_DRX_DP[18]	AM6	QPI	I
QPI1_DRX_DP[19]	AM8	QPI	I
QPI1_DRX_DP[2]	AY8	QPI	I
QPI1_DRX_DP[3]	AV5	QPI	I
QPI1_DRX_DP[4]	BA7	QPI	I
QPI1_DRX_DP[5]	AY6	QPI	I
QPI1_DRX_DP[6]	AU7	QPI	I
QPI1_DRX_DP[7]	AW4	QPI	I
QPI1_DRX_DP[8]	AU4	QPI	I
QPI1_DRX_DP[9]	AT3	QPI	I
QPI1_DTX_DN[0]	AH8	QPI	O
QPI1_DTX_DN[1]	AJ7	QPI	O
QPI1_DTX_DN[10]	AF3	QPI	O
QPI1_DTX_DN[11]	AD1	QPI	O
QPI1_DTX_DN[12]	AD3	QPI	O
QPI1_DTX_DN[13]	AB3	QPI	O
QPI1_DTX_DN[14]	AE4	QPI	O
QPI1_DTX_DN[15]	AD4	QPI	O
QPI1_DTX_DN[16]	AC6	QPI	O
QPI1_DTX_DN[17]	AD7	QPI	O
QPI1_DTX_DN[18]	AE5	QPI	O
QPI1_DTX_DN[19]	AD8	QPI	O
QPI1_DTX_DN[2]	AJ6	QPI	O
QPI1_DTX_DN[3]	AK5	QPI	O
QPI1_DTX_DN[4]	AK4	QPI	O
QPI1_DTX_DN[5]	AG6	QPI	O
QPI1_DTX_DN[6]	AJ2	QPI	O
QPI1_DTX_DN[7]	AJ1	QPI	O
QPI1_DTX_DN[8]	AH4	QPI	O
QPI1_DTX_DN[9]	AG2	QPI	O
QPI1_DTX_DP[0]	AG8	QPI	O
QPI1_DTX_DP[1]	AJ8	QPI	O
QPI1_DTX_DP[10]	AF2	QPI	O
QPI1_DTX_DP[11]	AE1	QPI	O
QPI1_DTX_DP[12]	AD2	QPI	O
QPI1_DTX_DP[13]	AC3	QPI	O
QPI1_DTX_DP[14]	AE3	QPI	O
QPI1_DTX_DP[15]	AC4	QPI	O
QPI1_DTX_DP[16]	AB6	QPI	O
QPI1_DTX_DP[17]	AD6	QPI	O

**Table 4-1. Land Listing by Land Name  
(Sheet 6 of 36)**

Land Name	Land No.	Buffer Type	Direction
QPI1_DTX_DP[18]	AD5	QPI	O
QPI1_DTX_DP[19]	AC8	QPI	O
QPI1_DTX_DP[2]	AH6	QPI	O
QPI1_DTX_DP[3]	AK6	QPI	O
QPI1_DTX_DP[4]	AJ4	QPI	O
QPI1_DTX_DP[5]	AG7	QPI	O
QPI1_DTX_DP[6]	AJ3	QPI	O
QPI1_DTX_DP[7]	AK1	QPI	O
QPI1_DTX_DP[8]	AH3	QPI	O
QPI1_DTX_DP[9]	AH2	QPI	O
DBR#	AF10	Asynch	I
DDR_COMP[0]	AA8	Analog	
DDR_COMP[1]	Y7	Analog	
DDR_COMP[2]	AC1	Analog	
DDR_THERM#	AB5	CMOS	I
DDR_VREF	L23	Analog	I
DDR0_BA[0]	B16	CMOS	O
DDR0_BA[1]	A16	CMOS	O
DDR0_BA[2]	C28	CMOS	O
DDR0_CAS#	C12	CMOS	O
DDR0_CKE[0]	C29	CMOS	O
DDR0_CKE[1]	A30	CMOS	O
DDR0_CKE[2]	B30	CMOS	O
DDR0_CKE[3]	B31	CMOS	O
DDR0_CLK_N[0]	K19	CLOCK	O
DDR0_CLK_N[1]	C19	CLOCK	O
DDR0_CLK_N[2]	E18	CLOCK	O
DDR0_CLK_N[3]	E19	CLOCK	O
DDR0_CLK_P[0]	J19	CLOCK	O
DDR0_CLK_P[1]	D19	CLOCK	O
DDR0_CLK_P[2]	F18	CLOCK	O
DDR0_CLK_P[3]	E20	CLOCK	O
DDR0_CS#[0]	G15	CMOS	O
DDR0_CS#[1]	B10	CMOS	O
DDR0_CS#[2]	C13	CMOS	O
DDR0_CS#[3]	B9	CMOS	O
DDR0_CS#[4]	B15	CMOS	O
DDR0_CS#[5]	A7	CMOS	O
DDR0_CS#[6]/ DDR0_ODT[4]	C11	CMOS	O



**Table 4-1. Land Listing by Land Name (Sheet 7 of 36)**

Land Name	Land No.	Buffer Type	Direction
DDR0_CS#[7]/DDR0_ODT[5]	B8	CMOS	O
DDR0_DQ[0]	W41	CMOS	I/O
DDR0_DQ[1]	V41	CMOS	I/O
DDR0_DQ[10]	K42	CMOS	I/O
DDR0_DQ[11]	K43	CMOS	I/O
DDR0_DQ[12]	P42	CMOS	I/O
DDR0_DQ[13]	P41	CMOS	I/O
DDR0_DQ[14]	L43	CMOS	I/O
DDR0_DQ[15]	L42	CMOS	I/O
DDR0_DQ[16]	H41	CMOS	I/O
DDR0_DQ[17]	H43	CMOS	I/O
DDR0_DQ[18]	E42	CMOS	I/O
DDR0_DQ[19]	E43	CMOS	I/O
DDR0_DQ[2]	R43	CMOS	I/O
DDR0_DQ[20]	J42	CMOS	I/O
DDR0_DQ[21]	J41	CMOS	I/O
DDR0_DQ[22]	F43	CMOS	I/O
DDR0_DQ[23]	F42	CMOS	I/O
DDR0_DQ[24]	D40	CMOS	I/O
DDR0_DQ[25]	C41	CMOS	I/O
DDR0_DQ[26]	A38	CMOS	I/O
DDR0_DQ[27]	D37	CMOS	I/O
DDR0_DQ[28]	D41	CMOS	I/O
DDR0_DQ[29]	D42	CMOS	I/O
DDR0_DQ[3]	R42	CMOS	I/O
DDR0_DQ[30]	C38	CMOS	I/O
DDR0_DQ[31]	B38	CMOS	I/O
DDR0_DQ[32]	B5	CMOS	I/O
DDR0_DQ[33]	C4	CMOS	I/O
DDR0_DQ[34]	F1	CMOS	I/O
DDR0_DQ[35]	G3	CMOS	I/O
DDR0_DQ[36]	B6	CMOS	I/O
DDR0_DQ[37]	C6	CMOS	I/O
DDR0_DQ[38]	F3	CMOS	I/O
DDR0_DQ[39]	F2	CMOS	I/O
DDR0_DQ[4]	W40	CMOS	I/O
DDR0_DQ[40]	H2	CMOS	I/O
DDR0_DQ[41]	H1	CMOS	I/O
DDR0_DQ[42]	L1	CMOS	I/O
DDR0_DQ[43]	M1	CMOS	I/O

**Table 4-1. Land Listing by Land Name (Sheet 8 of 36)**

Land Name	Land No.	Buffer Type	Direction
DDR0_DQ[44]	G1	CMOS	I/O
DDR0_DQ[45]	H3	CMOS	I/O
DDR0_DQ[46]	L3	CMOS	I/O
DDR0_DQ[47]	L2	CMOS	I/O
DDR0_DQ[48]	N1	CMOS	I/O
DDR0_DQ[49]	N2	CMOS	I/O
DDR0_DQ[5]	W42	CMOS	I/O
DDR0_DQ[50]	T1	CMOS	I/O
DDR0_DQ[51]	T2	CMOS	I/O
DDR0_DQ[52]	M3	CMOS	I/O
DDR0_DQ[53]	N3	CMOS	I/O
DDR0_DQ[54]	R4	CMOS	I/O
DDR0_DQ[55]	T3	CMOS	I/O
DDR0_DQ[56]	U4	CMOS	I/O
DDR0_DQ[57]	V1	CMOS	I/O
DDR0_DQ[58]	Y2	CMOS	I/O
DDR0_DQ[59]	Y3	CMOS	I/O
DDR0_DQ[6]	U41	CMOS	I/O
DDR0_DQ[60]	U1	CMOS	I/O
DDR0_DQ[61]	U3	CMOS	I/O
DDR0_DQ[62]	V4	CMOS	I/O
DDR0_DQ[63]	W4	CMOS	I/O
DDR0_DQ[7]	T42	CMOS	I/O
DDR0_DQ[8]	N41	CMOS	I/O
DDR0_DQ[9]	N43	CMOS	I/O
DDR0_DQS_N[0]	U43	CMOS	I/O
DDR0_DQS_N[1]	M41	CMOS	I/O
DDR0_DQS_N[10]	M43	CMOS	I/O
DDR0_DQS_N[11]	G43	CMOS	I/O
DDR0_DQS_N[12]	C39	CMOS	I/O
DDR0_DQS_N[13]	D4	CMOS	I/O
DDR0_DQS_N[14]	J1	CMOS	I/O
DDR0_DQS_N[15]	P1	CMOS	I/O
DDR0_DQS_N[16]	V3	CMOS	I/O
DDR0_DQS_N[17]	B35	CMOS	I/O
DDR0_DQS_N[2]	G41	CMOS	I/O
DDR0_DQS_N[3]	B40	CMOS	I/O
DDR0_DQS_N[4]	E4	CMOS	I/O
DDR0_DQS_N[5]	K3	CMOS	I/O
DDR0_DQS_N[6]	R3	CMOS	I/O



**Table 4-1. Land Listing by Land Name  
(Sheet 9 of 36)**

Land Name	Land No.	Buffer Type	Direction
DDR0_DQS_N[7]	W1	CMOS	I/O
DDR0_DQS_N[8]	D35	CMOS	I/O
DDR0_DQS_N[9]	V42	CMOS	I/O
DDR0_DQS_P[0]	T43	CMOS	I/O
DDR0_DQS_P[1]	L41	CMOS	I/O
DDR0_DQS_P[10]	N42	CMOS	I/O
DDR0_DQS_P[11]	H42	CMOS	I/O
DDR0_DQS_P[12]	D39	CMOS	I/O
DDR0_DQS_P[13]	D5	CMOS	I/O
DDR0_DQS_P[14]	J2	CMOS	I/O
DDR0_DQS_P[15]	P2	CMOS	I/O
DDR0_DQS_P[16]	V2	CMOS	I/O
DDR0_DQS_P[17]	B36	CMOS	I/O
DDR0_DQS_P[2]	F41	CMOS	I/O
DDR0_DQS_P[3]	B39	CMOS	I/O
DDR0_DQS_P[4]	E3	CMOS	I/O
DDR0_DQS_P[5]	K2	CMOS	I/O
DDR0_DQS_P[6]	R2	CMOS	I/O
DDR0_DQS_P[7]	W2	CMOS	I/O
DDR0_DQS_P[8]	D34	CMOS	I/O
DDR0_DQS_P[9]	V43	CMOS	I/O
DDR0_ECC[0]	C36	CMOS	I/O
DDR0_ECC[1]	A36	CMOS	I/O
DDR0_ECC[2]	F32	CMOS	I/O
DDR0_ECC[3]	C33	CMOS	I/O
DDR0_ECC[4]	C37	CMOS	I/O
DDR0_ECC[5]	A37	CMOS	I/O
DDR0_ECC[6]	B34	CMOS	I/O
DDR0_ECC[7]	C34	CMOS	I/O
DDR0_MA[0]	A20	CMOS	O
DDR0_MA[1]	B21	CMOS	O
DDR0_MA[10]	B19	CMOS	O
DDR0_MA[11]	A26	CMOS	O
DDR0_MA[12]	B26	CMOS	O
DDR0_MA[13]	A10	CMOS	O
DDR0_MA[14]	A28	CMOS	O
DDR0_MA[15]	B29	CMOS	O
DDR0_MA[2]	C23	CMOS	O
DDR0_MA[3]	D24	CMOS	O
DDR0_MA[4]	B23	CMOS	O

**Table 4-1. Land Listing by Land Name  
(Sheet 10 of 36)**

Land Name	Land No.	Buffer Type	Direction
DDR0_MA[5]	B24	CMOS	O
DDR0_MA[6]	C24	CMOS	O
DDR0_MA[7]	A25	CMOS	O
DDR0_MA[8]	B25	CMOS	O
DDR0_MA[9]	C26	CMOS	O
DDR0_MA_PAR	B20	CMOS	O
DDR0_ODT[0]	F12	CMOS	O
DDR0_ODT[1]	C9	CMOS	O
DDR0_ODT[2]	B11	CMOS	O
DDR0_ODT[3]	C7	CMOS	O
DDR0_PAR_ERR#[0]	D25	Asynch	I
DDR0_PAR_ERR#[1]	B28	Asynch	I
DDR0_PAR_ERR#[2]	A27	Asynch	I
DDR0_RAS#	A15	CMOS	O
DDR0_RESET#	D32	CMOS	O
DDR0_WE#	B13	CMOS	O
DDR1_BA[0]	C18	CMOS	O
DDR1_BA[1]	K13	CMOS	O
DDR1_BA[2]	H27	CMOS	O
DDR1_CAS#	E14	CMOS	O
DDR1_CKE[0]	H28	CMOS	O
DDR1_CKE[1]	E27	CMOS	O
DDR1_CKE[2]	D27	CMOS	O
DDR1_CKE[3]	C27	CMOS	O
DDR1_CLK_N[0]	D21	CLOCK	O
DDR1_CLK_N[1]	G20	CLOCK	O
DDR1_CLK_N[2]	L18	CLOCK	O
DDR1_CLK_N[3]	H19	CLOCK	O
DDR1_CLK_P[0]	C21	CLOCK	O
DDR1_CLK_P[1]	G19	CLOCK	O
DDR1_CLK_P[2]	K18	CLOCK	O
DDR1_CLK_P[3]	H18	CLOCK	O
DDR1_CS#[0]	D12	CMOS	O
DDR1_CS#[1]	A8	CMOS	O
DDR1_CS#[2]	E15	CMOS	O
DDR1_CS#[3]	E13	CMOS	O
DDR1_CS#[4]	C17	CMOS	O
DDR1_CS#[5]	E10	CMOS	O
DDR1_CS#[6]/ DDR1_ODT[4]	C14	CMOS	O



**Table 4-1. Land Listing by Land Name (Sheet 11 of 36)**

Land Name	Land No.	Buffer Type	Direction
DDR1_CS#[7]/DDR1_ODT[5]	E12	CMOS	O
DDR1_DQ[0]	AA37	CMOS	I/O
DDR1_DQ[1]	AA36	CMOS	I/O
DDR1_DQ[10]	P39	CMOS	I/O
DDR1_DQ[11]	N39	CMOS	I/O
DDR1_DQ[12]	R34	CMOS	I/O
DDR1_DQ[13]	R35	CMOS	I/O
DDR1_DQ[14]	N37	CMOS	I/O
DDR1_DQ[15]	N38	CMOS	I/O
DDR1_DQ[16]	M35	CMOS	I/O
DDR1_DQ[17]	M34	CMOS	I/O
DDR1_DQ[18]	K35	CMOS	I/O
DDR1_DQ[19]	J35	CMOS	I/O
DDR1_DQ[2]	Y35	CMOS	I/O
DDR1_DQ[20]	N34	CMOS	I/O
DDR1_DQ[21]	M36	CMOS	I/O
DDR1_DQ[22]	J36	CMOS	I/O
DDR1_DQ[23]	H36	CMOS	I/O
DDR1_DQ[24]	H33	CMOS	I/O
DDR1_DQ[25]	L33	CMOS	I/O
DDR1_DQ[26]	K32	CMOS	I/O
DDR1_DQ[27]	J32	CMOS	I/O
DDR1_DQ[28]	J34	CMOS	I/O
DDR1_DQ[29]	H34	CMOS	I/O
DDR1_DQ[3]	Y34	CMOS	I/O
DDR1_DQ[30]	L32	CMOS	I/O
DDR1_DQ[31]	K30	CMOS	I/O
DDR1_DQ[32]	E9	CMOS	I/O
DDR1_DQ[33]	E8	CMOS	I/O
DDR1_DQ[34]	E5	CMOS	I/O
DDR1_DQ[35]	F5	CMOS	I/O
DDR1_DQ[36]	F10	CMOS	I/O
DDR1_DQ[37]	G8	CMOS	I/O
DDR1_DQ[38]	D6	CMOS	I/O
DDR1_DQ[39]	F6	CMOS	I/O
DDR1_DQ[4]	AA35	CMOS	I/O
DDR1_DQ[40]	H8	CMOS	I/O
DDR1_DQ[41]	J6	CMOS	I/O
DDR1_DQ[42]	G4	CMOS	I/O
DDR1_DQ[43]	H4	CMOS	I/O

**Table 4-1. Land Listing by Land Name (Sheet 12 of 36)**

Land Name	Land No.	Buffer Type	Direction
DDR1_DQ[44]	G9	CMOS	I/O
DDR1_DQ[45]	H9	CMOS	I/O
DDR1_DQ[46]	G5	CMOS	I/O
DDR1_DQ[47]	J5	CMOS	I/O
DDR1_DQ[48]	K4	CMOS	I/O
DDR1_DQ[49]	K5	CMOS	I/O
DDR1_DQ[5]	AB36	CMOS	I/O
DDR1_DQ[50]	R5	CMOS	I/O
DDR1_DQ[51]	T5	CMOS	I/O
DDR1_DQ[52]	J4	CMOS	I/O
DDR1_DQ[53]	M6	CMOS	I/O
DDR1_DQ[54]	R8	CMOS	I/O
DDR1_DQ[55]	R7	CMOS	I/O
DDR1_DQ[56]	W6	CMOS	I/O
DDR1_DQ[57]	W7	CMOS	I/O
DDR1_DQ[58]	Y10	CMOS	I/O
DDR1_DQ[59]	W10	CMOS	I/O
DDR1_DQ[6]	Y40	CMOS	I/O
DDR1_DQ[60]	V9	CMOS	I/O
DDR1_DQ[61]	W5	CMOS	I/O
DDR1_DQ[62]	AA7	CMOS	I/O
DDR1_DQ[63]	W9	CMOS	I/O
DDR1_DQ[7]	Y39	CMOS	I/O
DDR1_DQ[8]	P34	CMOS	I/O
DDR1_DQ[9]	P35	CMOS	I/O
DDR1_DQS_N[0]	Y37	CMOS	I/O
DDR1_DQS_N[1]	R37	CMOS	I/O
DDR1_DQS_N[10]	P37	CMOS	I/O
DDR1_DQS_N[11]	K37	CMOS	I/O
DDR1_DQS_N[12]	K33	CMOS	I/O
DDR1_DQS_N[13]	F7	CMOS	I/O
DDR1_DQS_N[14]	J7	CMOS	I/O
DDR1_DQS_N[15]	M4	CMOS	I/O
DDR1_DQS_N[16]	Y5	CMOS	I/O
DDR1_DQS_N[17]	E35	CMOS	I/O
DDR1_DQS_N[2]	L36	CMOS	I/O
DDR1_DQS_N[3]	L31	CMOS	I/O
DDR1_DQS_N[4]	D7	CMOS	I/O
DDR1_DQS_N[5]	G6	CMOS	I/O
DDR1_DQS_N[6]	L5	CMOS	I/O



**Table 4-1. Land Listing by Land Name  
(Sheet 13 of 36)**

Land Name	Land No.	Buffer Type	Direction
DDR1_DQS_N[7]	Y9	CMOS	I/O
DDR1_DQS_N[8]	G34	CMOS	I/O
DDR1_DQS_N[9]	AA41	CMOS	I/O
DDR1_DQS_P[0]	Y38	CMOS	I/O
DDR1_DQS_P[1]	R38	CMOS	I/O
DDR1_DQS_P[10]	P36	CMOS	I/O
DDR1_DQS_P[11]	L37	CMOS	I/O
DDR1_DQS_P[12]	K34	CMOS	I/O
DDR1_DQS_P[13]	F8	CMOS	I/O
DDR1_DQS_P[14]	H7	CMOS	I/O
DDR1_DQS_P[15]	M5	CMOS	I/O
DDR1_DQS_P[16]	Y4	CMOS	I/O
DDR1_DQS_P[17]	F35	CMOS	I/O
DDR1_DQS_P[2]	L35	CMOS	I/O
DDR1_DQS_P[3]	L30	CMOS	I/O
DDR1_DQS_P[4]	E7	CMOS	I/O
DDR1_DQS_P[5]	H6	CMOS	I/O
DDR1_DQS_P[6]	L6	CMOS	I/O
DDR1_DQS_P[7]	Y8	CMOS	I/O
DDR1_DQS_P[8]	G33	CMOS	I/O
DDR1_DQS_P[9]	AA40	CMOS	I/O
DDR1_ECC[0]	D36	CMOS	I/O
DDR1_ECC[1]	F36	CMOS	I/O
DDR1_ECC[2]	E33	CMOS	I/O
DDR1_ECC[3]	G36	CMOS	I/O
DDR1_ECC[4]	E37	CMOS	I/O
DDR1_ECC[5]	F37	CMOS	I/O
DDR1_ECC[6]	E34	CMOS	I/O
DDR1_ECC[7]	G35	CMOS	I/O
DDR1_MA[0]	J14	CMOS	O
DDR1_MA[1]	J16	CMOS	O
DDR1_MA[10]	H14	CMOS	O
DDR1_MA[11]	E23	CMOS	O
DDR1_MA[12]	E24	CMOS	O
DDR1_MA[13]	B14	CMOS	O
DDR1_MA[14]	H26	CMOS	O
DDR1_MA[15]	F26	CMOS	O
DDR1_MA[2]	J17	CMOS	O
DDR1_MA[3]	L28	CMOS	O
DDR1_MA[4]	K28	CMOS	O

**Table 4-1. Land Listing by Land Name  
(Sheet 14 of 36)**

Land Name	Land No.	Buffer Type	Direction
DDR1_MA[5]	F22	CMOS	O
DDR1_MA[6]	J27	CMOS	O
DDR1_MA[7]	D22	CMOS	O
DDR1_MA[8]	E22	CMOS	O
DDR1_MA[9]	G24	CMOS	O
DDR1_MA_PAR	D20	CMOS	O
DDR1_ODT[0]	D11	CMOS	O
DDR1_ODT[1]	C8	CMOS	O
DDR1_ODT[2]	D14	CMOS	O
DDR1_ODT[3]	F11	CMOS	O
DDR1_PAR_ERR#[0]	C22	Asynch	I
DDR1_PAR_ERR#[1]	E25	Asynch	I
DDR1_PAR_ERR#[2]	F25	Asynch	I
DDR1_RAS#	G14	CMOS	O
DDR1_RESET#	D29	CMOS	O
DDR1_WE#	G13	CMOS	O
DDR2_BA[0]	A17	CMOS	O
DDR2_BA[1]	F17	CMOS	O
DDR2_BA[2]	L26	CMOS	O
DDR2_CAS#	F16	CMOS	O
DDR2_CKE[0]	J26	CMOS	O
DDR2_CKE[1]	G26	CMOS	O
DDR2_CKE[2]	D26	CMOS	O
DDR2_CKE[3]	L27	CMOS	O
DDR2_CLK_N[0]	J21	CLOCK	O
DDR2_CLK_N[1]	K20	CLOCK	O
DDR2_CLK_N[2]	G21	CLOCK	O
DDR2_CLK_N[3]	L21	CLOCK	O
DDR2_CLK_P[0]	J22	CLOCK	O
DDR2_CLK_P[1]	L20	CLOCK	O
DDR2_CLK_P[2]	H21	CLOCK	O
DDR2_CLK_P[3]	L22	CLOCK	O
DDR2_CS#[0]	G16	CMOS	O
DDR2_CS#[1]	K14	CMOS	O
DDR2_CS#[2]	D16	CMOS	O
DDR2_CS#[3]	H16	CMOS	O
DDR2_CS#[4]	E17	CMOS	O
DDR2_CS#[5]	D9	CMOS	O
DDR2_CS#[6]/ DDR2_ODT[4]	L17	CMOS	O



**Table 4-1. Land Listing by Land Name (Sheet 15 of 36)**

Land Name	Land No.	Buffer Type	Direction
DDR2_CS#[7]/DDR2_ODT[5]	J15	CMOS	O
DDR2_DQ[0]	W34	CMOS	I/O
DDR2_DQ[1]	W35	CMOS	I/O
DDR2_DQ[10]	R39	CMOS	I/O
DDR2_DQ[11]	T36	CMOS	I/O
DDR2_DQ[12]	W39	CMOS	I/O
DDR2_DQ[13]	V39	CMOS	I/O
DDR2_DQ[14]	T41	CMOS	I/O
DDR2_DQ[15]	R40	CMOS	I/O
DDR2_DQ[16]	M39	CMOS	I/O
DDR2_DQ[17]	M40	CMOS	I/O
DDR2_DQ[18]	J40	CMOS	I/O
DDR2_DQ[19]	J39	CMOS	I/O
DDR2_DQ[2]	V36	CMOS	I/O
DDR2_DQ[20]	P40	CMOS	I/O
DDR2_DQ[21]	N36	CMOS	I/O
DDR2_DQ[22]	L40	CMOS	I/O
DDR2_DQ[23]	K38	CMOS	I/O
DDR2_DQ[24]	G40	CMOS	I/O
DDR2_DQ[25]	F40	CMOS	I/O
DDR2_DQ[26]	J37	CMOS	I/O
DDR2_DQ[27]	H37	CMOS	I/O
DDR2_DQ[28]	H39	CMOS	I/O
DDR2_DQ[29]	G39	CMOS	I/O
DDR2_DQ[3]	U36	CMOS	I/O
DDR2_DQ[30]	F38	CMOS	I/O
DDR2_DQ[31]	E38	CMOS	I/O
DDR2_DQ[32]	K12	CMOS	I/O
DDR2_DQ[33]	J12	CMOS	I/O
DDR2_DQ[34]	H13	CMOS	I/O
DDR2_DQ[35]	L13	CMOS	I/O
DDR2_DQ[36]	G11	CMOS	I/O
DDR2_DQ[37]	G10	CMOS	I/O
DDR2_DQ[38]	H12	CMOS	I/O
DDR2_DQ[39]	L12	CMOS	I/O
DDR2_DQ[4]	U34	CMOS	I/O
DDR2_DQ[40]	L10	CMOS	I/O
DDR2_DQ[41]	K10	CMOS	I/O
DDR2_DQ[42]	M9	CMOS	I/O
DDR2_DQ[43]	N9	CMOS	I/O

**Table 4-1. Land Listing by Land Name (Sheet 16 of 36)**

Land Name	Land No.	Buffer Type	Direction
DDR2_DQ[44]	L11	CMOS	I/O
DDR2_DQ[45]	M10	CMOS	I/O
DDR2_DQ[46]	L8	CMOS	I/O
DDR2_DQ[47]	M8	CMOS	I/O
DDR2_DQ[48]	P7	CMOS	I/O
DDR2_DQ[49]	N6	CMOS	I/O
DDR2_DQ[5]	V34	CMOS	I/O
DDR2_DQ[50]	P9	CMOS	I/O
DDR2_DQ[51]	P10	CMOS	I/O
DDR2_DQ[52]	N8	CMOS	I/O
DDR2_DQ[53]	N7	CMOS	I/O
DDR2_DQ[54]	R10	CMOS	I/O
DDR2_DQ[55]	R9	CMOS	I/O
DDR2_DQ[56]	U5	CMOS	I/O
DDR2_DQ[57]	U6	CMOS	I/O
DDR2_DQ[58]	T10	CMOS	I/O
DDR2_DQ[59]	U10	CMOS	I/O
DDR2_DQ[6]	V37	CMOS	I/O
DDR2_DQ[60]	T6	CMOS	I/O
DDR2_DQ[61]	T7	CMOS	I/O
DDR2_DQ[62]	V8	CMOS	I/O
DDR2_DQ[63]	U9	CMOS	I/O
DDR2_DQ[7]	V38	CMOS	I/O
DDR2_DQ[8]	U38	CMOS	I/O
DDR2_DQ[9]	U39	CMOS	I/O
DDR2_DQS_N[0]	W36	CMOS	I/O
DDR2_DQS_N[1]	T38	CMOS	I/O
DDR2_DQS_N[10]	T40	CMOS	I/O
DDR2_DQS_N[11]	L38	CMOS	I/O
DDR2_DQS_N[12]	G38	CMOS	I/O
DDR2_DQS_N[13]	J11	CMOS	I/O
DDR2_DQS_N[14]	K8	CMOS	I/O
DDR2_DQS_N[15]	P4	CMOS	I/O
DDR2_DQS_N[16]	V7	CMOS	I/O
DDR2_DQS_N[17]	G31	CMOS	I/O
DDR2_DQS_N[2]	K39	CMOS	I/O
DDR2_DQS_N[3]	E40	CMOS	I/O
DDR2_DQS_N[4]	J9	CMOS	I/O
DDR2_DQS_N[5]	K7	CMOS	I/O
DDR2_DQS_N[6]	P5	CMOS	I/O





**Table 4-1. Land Listing by Land Name  
(Sheet 17 of 36)**

Land Name	Land No.	Buffer Type	Direction
DDR2_DQS_N[7]	T8	CMOS	I/O
DDR2_DQS_N[8]	G30	CMOS	I/O
DDR2_DQS_N[9]	T35	CMOS	I/O
DDR2_DQS_P[0]	W37	CMOS	I/O
DDR2_DQS_P[1]	T37	CMOS	I/O
DDR2_DQS_P[10]	U40	CMOS	I/O
DDR2_DQS_P[11]	M38	CMOS	I/O
DDR2_DQS_P[12]	H38	CMOS	I/O
DDR2_DQS_P[13]	H11	CMOS	I/O
DDR2_DQS_P[14]	K9	CMOS	I/O
DDR2_DQS_P[15]	N4	CMOS	I/O
DDR2_DQS_P[16]	V6	CMOS	I/O
DDR2_DQS_P[17]	H31	CMOS	I/O
DDR2_DQS_P[2]	K40	CMOS	I/O
DDR2_DQS_P[3]	E39	CMOS	I/O
DDR2_DQS_P[4]	J10	CMOS	I/O
DDR2_DQS_P[5]	L7	CMOS	I/O
DDR2_DQS_P[6]	P6	CMOS	I/O
DDR2_DQS_P[7]	U8	CMOS	I/O
DDR2_DQS_P[8]	G29	CMOS	I/O
DDR2_DQS_P[9]	U35	CMOS	I/O
DDR2_ECC[0]	H32	CMOS	I/O
DDR2_ECC[1]	F33	CMOS	I/O
DDR2_ECC[2]	E29	CMOS	I/O
DDR2_ECC[3]	E30	CMOS	I/O
DDR2_ECC[4]	J31	CMOS	I/O
DDR2_ECC[5]	J30	CMOS	I/O
DDR2_ECC[6]	F31	CMOS	I/O
DDR2_ECC[7]	F30	CMOS	I/O
DDR2_MA[0]	A18	CMOS	O
DDR2_MA[1]	K17	CMOS	O
DDR2_MA[10]	H17	CMOS	O
DDR2_MA[11]	H23	CMOS	O
DDR2_MA[12]	G23	CMOS	O
DDR2_MA[13]	F15	CMOS	O
DDR2_MA[14]	H24	CMOS	O
DDR2_MA[15]	G25	CMOS	O
DDR2_MA[2]	G18	CMOS	O
DDR2_MA[3]	J20	CMOS	O
DDR2_MA[4]	F20	CMOS	O

**Table 4-1. Land Listing by Land Name  
(Sheet 18 of 36)**

Land Name	Land No.	Buffer Type	Direction
DDR2_MA[5]	K23	CMOS	O
DDR2_MA[6]	K22	CMOS	O
DDR2_MA[7]	J24	CMOS	O
DDR2_MA[8]	L25	CMOS	O
DDR2_MA[9]	H22	CMOS	O
DDR2_MA_PAR	B18	CMOS	O
DDR2_ODT[0]	L16	CMOS	O
DDR2_ODT[1]	F13	CMOS	O
DDR2_ODT[2]	D15	CMOS	O
DDR2_ODT[3]	D10	CMOS	O
DDR2_PAR_ERR#[0]	F21	Asynch	I
DDR2_PAR_ERR#[1]	J25	Asynch	I
DDR2_PAR_ERR#[2]	F23	Asynch	I
DDR2_RAS#	D17	CMOS	O
DDR2_RESET#	E32	CMOS	O
DDR2_WE#	C16	CMOS	O
FC_AH5	AH5		
GTLREF	AJ37	Analog	I
ISENSE	AK8	Analog	I
PECI	AH36	Asynch	I/O
PECI_ID#	AK35	Asynch	I
PRDY#	B41	GTL	O
PREQ#	C42	GTL	I
PROCHOT#	AG35	GTL	I/O
PSI#	AP7	CMOS	O
RESET#	AL39	Asynch	I
RSVD	A31		
RSVD	A40		
RSVD	AF1		
RSVD	AF4		
RSVD	AG1		
RSVD	AG4		
RSVD	AG5		
RSVD	AK2		
RSVD	AK7		
RSVD	AK36		
RSVD	AL3		
RSVD	AL38		
RSVD	AL4		
RSVD	AL40		



**Table 4-1. Land Listing by Land Name  
(Sheet 19 of 36)**

Land Name	Land No.	Buffer Type	Direction
RSVD	AL41		
RSVD	AL5		
RSVD	AM36		
RSVD	AM38		
RSVD	AN36		
RSVD	AN38		
RSVD	AR36		
RSVD	AR37		
RSVD	AT36		
RSVD	AT4		
RSVD	AT5		
RSVD	AU2		
RSVD	AV1		
RSVD	AV2		
RSVD	AV35		
RSVD	AV42		
RSVD	AV43		
RSVD	AW2		
RSVD	AW39		
RSVD	AW41		
RSVD	AW42		
RSVD	AY3		
RSVD	AY35		
RSVD	AY39		
RSVD	AY4		
RSVD	AY40		
RSVD	AY41		
RSVD	B33		
RSVD	BA4		
RSVD	BA40		
RSVD	C31		
RSVD	C32		
RSVD	D30		
RSVD	D31		
RSVD	E28		
RSVD	F27		
RSVD	F28		
RSVD	G28		
RSVD	H29		
RSVD	J29		

**Table 4-1. Land Listing by Land Name  
(Sheet 20 of 36)**

Land Name	Land No.	Buffer Type	Direction
RSVD	K15		
RSVD	K24		
RSVD	K25		
RSVD	K27		
RSVD	K29		
RSVD	L15		
RSVD	U11		
RSVD	V11		
SKTOCC#	AG36	GTL	O
TCK	AH10	TAP	I
TDI	AJ9	TAP	I
TDO	AJ10	TAP	O
THERMTRIP#	AG37	GTL	O
TMS	AG10	TAP	I
TRST#	AH9	TAP	I
VCC	AH11	PWR	
VCC	AH33	PWR	
VCC	AJ11	PWR	
VCC	AJ33	PWR	
VCC	AK11	PWR	
VCC	AK12	PWR	
VCC	AK13	PWR	
VCC	AK15	PWR	
VCC	AK16	PWR	
VCC	AK18	PWR	
VCC	AK19	PWR	
VCC	AK21	PWR	
VCC	AK24	PWR	
VCC	AK25	PWR	
VCC	AK27	PWR	
VCC	AK28	PWR	
VCC	AK30	PWR	
VCC	AK31	PWR	
VCC	AK33	PWR	
VCC	AL12	PWR	
VCC	AL13	PWR	
VCC	AL15	PWR	
VCC	AL16	PWR	
VCC	AL18	PWR	
VCC	AL19	PWR	



**Table 4-1. Land Listing by Land Name  
(Sheet 21 of 36)**

Land Name	Land No.	Buffer Type	Direction
VCC	AL21	PWR	
VCC	AL24	PWR	
VCC	AL25	PWR	
VCC	AL27	PWR	
VCC	AL28	PWR	
VCC	AL30	PWR	
VCC	AL31	PWR	
VCC	AL33	PWR	
VCC	AL34	PWR	
VCC	AM12	PWR	
VCC	AM13	PWR	
VCC	AM15	PWR	
VCC	AM16	PWR	
VCC	AM18	PWR	
VCC	AM19	PWR	
VCC	AM21	PWR	
VCC	AM24	PWR	
VCC	AM25	PWR	
VCC	AM27	PWR	
VCC	AM28	PWR	
VCC	AM30	PWR	
VCC	AM31	PWR	
VCC	AM33	PWR	
VCC	AM34	PWR	
VCC	AN12	PWR	
VCC	AN13	PWR	
VCC	AN15	PWR	
VCC	AN16	PWR	
VCC	AN18	PWR	
VCC	AN19	PWR	
VCC	AN21	PWR	
VCC	AN24	PWR	
VCC	AN25	PWR	
VCC	AN27	PWR	
VCC	AN28	PWR	
VCC	AN30	PWR	
VCC	AN31	PWR	
VCC	AN33	PWR	
VCC	AN34	PWR	
VCC	AP12	PWR	

**Table 4-1. Land Listing by Land Name  
(Sheet 22 of 36)**

Land Name	Land No.	Buffer Type	Direction
VCC	AP13	PWR	
VCC	AP15	PWR	
VCC	AP16	PWR	
VCC	AP18	PWR	
VCC	AP19	PWR	
VCC	AP21	PWR	
VCC	AP24	PWR	
VCC	AP25	PWR	
VCC	AP27	PWR	
VCC	AP28	PWR	
VCC	AP30	PWR	
VCC	AP31	PWR	
VCC	AP33	PWR	
VCC	AP34	PWR	
VCC	AR10	PWR	
VCC	AR12	PWR	
VCC	AR13	PWR	
VCC	AR15	PWR	
VCC	AR16	PWR	
VCC	AR18	PWR	
VCC	AR19	PWR	
VCC	AR21	PWR	
VCC	AR24	PWR	
VCC	AR25	PWR	
VCC	AR27	PWR	
VCC	AR28	PWR	
VCC	AR30	PWR	
VCC	AR31	PWR	
VCC	AR33	PWR	
VCC	AR34	PWR	
VCC	AT10	PWR	
VCC	AT12	PWR	
VCC	AT13	PWR	
VCC	AT15	PWR	
VCC	AT16	PWR	
VCC	AT18	PWR	
VCC	AT19	PWR	
VCC	AT21	PWR	
VCC	AT24	PWR	
VCC	AT25	PWR	



**Table 4-1. Land Listing by Land Name  
(Sheet 23 of 36)**

Land Name	Land No.	Buffer Type	Direction
VCC	AT27	PWR	
VCC	AT28	PWR	
VCC	AT30	PWR	
VCC	AT31	PWR	
VCC	AT33	PWR	
VCC	AT34	PWR	
VCC	AT9	PWR	
VCC	AU10	PWR	
VCC	AU12	PWR	
VCC	AU13	PWR	
VCC	AU15	PWR	
VCC	AU16	PWR	
VCC	AU18	PWR	
VCC	AU19	PWR	
VCC	AU21	PWR	
VCC	AU24	PWR	
VCC	AU25	PWR	
VCC	AU27	PWR	
VCC	AU28	PWR	
VCC	AU30	PWR	
VCC	AU31	PWR	
VCC	AU33	PWR	
VCC	AU34	PWR	
VCC	AU9	PWR	
VCC	AV10	PWR	
VCC	AV12	PWR	
VCC	AV13	PWR	
VCC	AV15	PWR	
VCC	AV16	PWR	
VCC	AV18	PWR	
VCC	AV19	PWR	
VCC	AV21	PWR	
VCC	AV24	PWR	
VCC	AV25	PWR	
VCC	AV27	PWR	
VCC	AV28	PWR	
VCC	AV30	PWR	
VCC	AV31	PWR	
VCC	AV33	PWR	
VCC	AV34	PWR	

**Table 4-1. Land Listing by Land Name  
(Sheet 24 of 36)**

Land Name	Land No.	Buffer Type	Direction
VCC	AV9	PWR	
VCC	AW10	PWR	
VCC	AW12	PWR	
VCC	AW13	PWR	
VCC	AW15	PWR	
VCC	AW16	PWR	
VCC	AW18	PWR	
VCC	AW19	PWR	
VCC	AW21	PWR	
VCC	AW24	PWR	
VCC	AW25	PWR	
VCC	AW27	PWR	
VCC	AW28	PWR	
VCC	AW30	PWR	
VCC	AW31	PWR	
VCC	AW33	PWR	
VCC	AW34	PWR	
VCC	AW9	PWR	
VCC	AY10	PWR	
VCC	AY12	PWR	
VCC	AY13	PWR	
VCC	AY15	PWR	
VCC	AY16	PWR	
VCC	AY18	PWR	
VCC	AY19	PWR	
VCC	AY21	PWR	
VCC	AY24	PWR	
VCC	AY25	PWR	
VCC	AY27	PWR	
VCC	AY28	PWR	
VCC	AY30	PWR	
VCC	AY31	PWR	
VCC	AY33	PWR	
VCC	AY34	PWR	
VCC	AY9	PWR	
VCC	BA10	PWR	
VCC	BA12	PWR	
VCC	BA13	PWR	
VCC	BA15	PWR	
VCC	BA16	PWR	



**Table 4-1. Land Listing by Land Name  
(Sheet 25 of 36)**

Land Name	Land No.	Buffer Type	Direction
VCC	BA18	PWR	
VCC	BA19	PWR	
VCC	BA24	PWR	
VCC	BA25	PWR	
VCC	BA27	PWR	
VCC	BA28	PWR	
VCC	BA30	PWR	
VCC	BA9	PWR	
VCC	M11	PWR	
VCC	M13	PWR	
VCC	M15	PWR	
VCC	M19	PWR	
VCC	M21	PWR	
VCC	M23	PWR	
VCC	M25	PWR	
VCC	M29	PWR	
VCC	M31	PWR	
VCC	M33	PWR	
VCC	N11	PWR	
VCC	N33	PWR	
VCC	R11	PWR	
VCC	R33	PWR	
VCC	T11	PWR	
VCC	T33	PWR	
VCC	W11	PWR	
VCC_SENSE	AR9	Analog	
VCCPLL	U33	PWR	
VCCPLL	V33	PWR	
VCCPLL	W33	PWR	
VCCPWGOOD	AR7	Asynch	I
VDDPWGOOD	AA6	Asynch	I
VDDQ	A14	PWR	
VDDQ	A19	PWR	
VDDQ	A24	PWR	
VDDQ	A29	PWR	
VDDQ	A9	PWR	
VDDQ	B12	PWR	
VDDQ	B17	PWR	
VDDQ	B22	PWR	
VDDQ	B27	PWR	

**Table 4-1. Land Listing by Land Name  
(Sheet 26 of 36)**

Land Name	Land No.	Buffer Type	Direction
VDDQ	B32	PWR	
VDDQ	B7	PWR	
VDDQ	C10	PWR	
VDDQ	C15	PWR	
VDDQ	C20	PWR	
VDDQ	C25	PWR	
VDDQ	C30	PWR	
VDDQ	D13	PWR	
VDDQ	D18	PWR	
VDDQ	D23	PWR	
VDDQ	D28	PWR	
VDDQ	E11	PWR	
VDDQ	E16	PWR	
VDDQ	E21	PWR	
VDDQ	E26	PWR	
VDDQ	E31	PWR	
VDDQ	F14	PWR	
VDDQ	F19	PWR	
VDDQ	F24	PWR	
VDDQ	G17	PWR	
VDDQ	G22	PWR	
VDDQ	G27	PWR	
VDDQ	H15	PWR	
VDDQ	H20	PWR	
VDDQ	H25	PWR	
VDDQ	J18	PWR	
VDDQ	J23	PWR	
VDDQ	J28	PWR	
VDDQ	K16	PWR	
VDDQ	K21	PWR	
VDDQ	K26	PWR	
VDDQ	L14	PWR	
VDDQ	L19	PWR	
VDDQ	L24	PWR	
VDDQ	M17	PWR	
VDDQ	M27	PWR	
VID[0]/MSID[0]	AL10	CMOS	O
VID[1]/MSID[1]	AL9	CMOS	O
VID[2]/MSID[2]	AN9	CMOS	O
VID[3]/CSC[0]	AM10	CMOS	O



**Table 4-1. Land Listing by Land Name  
(Sheet 27 of 36)**

Land Name	Land No.	Buffer Type	Direction
VID[4]/CSC[1]	AN10	CMOS	O
VID[5]/CSC[2]	AP9	CSMO	O
VID[6]	AP8	CMOS	O
VID[7]	AN8	CMOS	O
VSS	A35	GND	
VSS	A39	GND	
VSS	A4	GND	
VSS	A41	GND	
VSS	A6	GND	
VSS	AA3	GND	
VSS	AA34	GND	
VSS	AA38	GND	
VSS	AA39	GND	
VSS	AA9	GND	
VSS	AB37	GND	
VSS	AB4	GND	
VSS	AB40	GND	
VSS	AB42	GND	
VSS	AB7	GND	
VSS	AC2	GND	
VSS	AC36	GND	
VSS	AC5	GND	
VSS	AC7	GND	
VSS	AC9	GND	
VSS	AD11	GND	
VSS	AD33	GND	
VSS	AD37	GND	
VSS	AD41	GND	
VSS	AD43	GND	
VSS	AE2	GND	
VSS	AE39	GND	
VSS	AE7	GND	
VSS	AF35	GND	
VSS	AF38	GND	
VSS	AF41	GND	
VSS	AF5	GND	
VSS	AG11	GND	
VSS	AG3	GND	
VSS	AG33	GND	
VSS	AG43	GND	

**Table 4-1. Land Listing by Land Name  
(Sheet 28 of 36)**

Land Name	Land No.	Buffer Type	Direction
VSS	AG9	GND	
VSS	AH1	GND	
VSS	AH34	GND	
VSS	AH37	GND	
VSS	AH39	GND	
VSS	AH7	GND	
VSS	AJ34	GND	
VSS	AJ36	GND	
VSS	AJ41	GND	
VSS	AJ5	GND	
VSS	AK10	GND	
VSS	AK14	GND	
VSS	AK17	GND	
VSS	AK20	GND	
VSS	AK22	GND	
VSS	AK23	GND	
VSS	AK26	GND	
VSS	AK29	GND	
VSS	AK3	GND	
VSS	AK32	GND	
VSS	AK34	GND	
VSS	AK39	GND	
VSS	AK43	GND	
VSS	AK9	GND	
VSS	AL1	GND	
VSS	AL11	GND	
VSS	AL14	GND	
VSS	AL17	GND	
VSS	AL2	GND	
VSS	AL20	GND	
VSS	AL22	GND	
VSS	AL23	GND	
VSS	AL26	GND	
VSS	AL29	GND	
VSS	AL32	GND	
VSS	AL35	GND	
VSS	AL36	GND	
VSS	AL37	GND	
VSS	AL42	GND	
VSS	AL7	GND	



**Table 4-1. Land Listing by Land Name  
(Sheet 29 of 36)**

Land Name	Land No.	Buffer Type	Direction
VSS	AM11	GND	
VSS	AM14	GND	
VSS	AM17	GND	
VSS	AM20	GND	
VSS	AM22	GND	
VSS	AM23	GND	
VSS	AM26	GND	
VSS	AM29	GND	
VSS	AM32	GND	
VSS	AM35	GND	
VSS	AM37	GND	
VSS	AM39	GND	
VSS	AM5	GND	
VSS	AM9	GND	
VSS	AN11	GND	
VSS	AN14	GND	
VSS	AN17	GND	
VSS	AN20	GND	
VSS	AN22	GND	
VSS	AN23	GND	
VSS	AN26	GND	
VSS	AN29	GND	
VSS	AN3	GND	
VSS	AN32	GND	
VSS	AN35	GND	
VSS	AN37	GND	
VSS	AN41	GND	
VSS	AN7	GND	
VSS	AP1	GND	
VSS	AP10	GND	
VSS	AP11	GND	
VSS	AP14	GND	
VSS	AP17	GND	
VSS	AP20	GND	
VSS	AP22	GND	
VSS	AP23	GND	
VSS	AP26	GND	
VSS	AP29	GND	
VSS	AP32	GND	
VSS	AP35	GND	

**Table 4-1. Land Listing by Land Name  
(Sheet 30 of 36)**

Land Name	Land No.	Buffer Type	Direction
VSS	AP36	GND	
VSS	AP37	GND	
VSS	AP43	GND	
VSS	AP5	GND	
VSS	AP6	GND	
VSS	AR11	GND	
VSS	AR14	GND	
VSS	AR17	GND	
VSS	AR2	GND	
VSS	AR20	GND	
VSS	AR22	GND	
VSS	AR23	GND	
VSS	AR26	GND	
VSS	AR29	GND	
VSS	AR3	GND	
VSS	AR32	GND	
VSS	AR35	GND	
VSS	AR39	GND	
VSS	AT11	GND	
VSS	AT14	GND	
VSS	AT17	GND	
VSS	AT20	GND	
VSS	AT22	GND	
VSS	AT23	GND	
VSS	AT26	GND	
VSS	AT29	GND	
VSS	AT32	GND	
VSS	AT35	GND	
VSS	AT38	GND	
VSS	AT41	GND	
VSS	AT7	GND	
VSS	AT8	GND	
VSS	AU1	GND	
VSS	AU11	GND	
VSS	AU14	GND	
VSS	AU17	GND	
VSS	AU20	GND	
VSS	AU22	GND	
VSS	AU23	GND	
VSS	AU26	GND	



**Table 4-1. Land Listing by Land Name  
(Sheet 31 of 36)**

Land Name	Land No.	Buffer Type	Direction
VSS	AU29	GND	
VSS	AU32	GND	
VSS	AU35	GND	
VSS	AU36	GND	
VSS	AU43	GND	
VSS	AU5	GND	
VSS	AV11	GND	
VSS	AV14	GND	
VSS	AV17	GND	
VSS	AV20	GND	
VSS	AV22	GND	
VSS	AV23	GND	
VSS	AV26	GND	
VSS	AV29	GND	
VSS	AV32	GND	
VSS	AV39	GND	
VSS	AV4	GND	
VSS	AV41	GND	
VSS	AW1	GND	
VSS	AW11	GND	
VSS	AW14	GND	
VSS	AW17	GND	
VSS	AW20	GND	
VSS	AW22	GND	
VSS	AW23	GND	
VSS	AW26	GND	
VSS	AW29	GND	
VSS	AW32	GND	
VSS	AW35	GND	
VSS	AW6	GND	
VSS	AW8	GND	
VSS	AY11	GND	
VSS	AY14	GND	
VSS	AY17	GND	
VSS	AY2	GND	
VSS	AY20	GND	
VSS	AY22	GND	
VSS	AY23	GND	
VSS	AY26	GND	
VSS	AY29	GND	

**Table 4-1. Land Listing by Land Name  
(Sheet 32 of 36)**

Land Name	Land No.	Buffer Type	Direction
VSS	AY32	GND	
VSS	AY37	GND	
VSS	AY42	GND	
VSS	AY7	GND	
VSS	B2	GND	
VSS	B37	GND	
VSS	B42	GND	
VSS	BA11	GND	
VSS	BA14	GND	
VSS	BA17	GND	
VSS	BA20	GND	
VSS	BA26	GND	
VSS	BA29	GND	
VSS	BA3	GND	
VSS	BA35	GND	
VSS	BA39	GND	
VSS	BA5	GND	
VSS	C35	GND	
VSS	C40	GND	
VSS	C43	GND	
VSS	C5	GND	
VSS	D3	GND	
VSS	D33	GND	
VSS	D38	GND	
VSS	D43	GND	
VSS	D8	GND	
VSS	E1	GND	
VSS	E36	GND	
VSS	E41	GND	
VSS	E6	GND	
VSS	F29	GND	
VSS	F34	GND	
VSS	F39	GND	
VSS	F4	GND	
VSS	F9	GND	
VSS	G12	GND	
VSS	G2	GND	
VSS	G32	GND	
VSS	G37	GND	
VSS	G42	GND	





**Table 4-1. Land Listing by Land Name  
(Sheet 33 of 36)**

Land Name	Land No.	Buffer Type	Direction
VSS	G7	GND	
VSS	H10	GND	
VSS	H30	GND	
VSS	H35	GND	
VSS	H40	GND	
VSS	H5	GND	
VSS	J13	GND	
VSS	J3	GND	
VSS	J33	GND	
VSS	J38	GND	
VSS	J43	GND	
VSS	J8	GND	
VSS	K1	GND	
VSS	K11	GND	
VSS	K31	GND	
VSS	K36	GND	
VSS	K41	GND	
VSS	K6	GND	
VSS	L29	GND	
VSS	L34	GND	
VSS	L39	GND	
VSS	L4	GND	
VSS	L9	GND	
VSS	M12	GND	
VSS	M14	GND	
VSS	M16	GND	
VSS	M18	GND	
VSS	M2	GND	
VSS	M20	GND	
VSS	M22	GND	
VSS	M24	GND	
VSS	M26	GND	
VSS	M28	GND	
VSS	M30	GND	
VSS	M32	GND	
VSS	M37	GND	
VSS	M42	GND	
VSS	M7	GND	
VSS	N10	GND	
VSS	N35	GND	

**Table 4-1. Land Listing by Land Name  
(Sheet 34 of 36)**

Land Name	Land No.	Buffer Type	Direction
VSS	N40	GND	
VSS	N5	GND	
VSS	P11	GND	
VSS	P3	GND	
VSS	P33	GND	
VSS	P38	GND	
VSS	P43	GND	
VSS	P8	GND	
VSS	R1	GND	
VSS	R36	GND	
VSS	R41	GND	
VSS	R6	GND	
VSS	T34	GND	
VSS	T39	GND	
VSS	T4	GND	
VSS	T9	GND	
VSS	U2	GND	
VSS	U37	GND	
VSS	U42	GND	
VSS	U7	GND	
VSS	V10	GND	
VSS	V35	GND	
VSS	V40	GND	
VSS	V5	GND	
VSS	W3	GND	
VSS	W38	GND	
VSS	W43	GND	
VSS	W8	GND	
VSS	Y1	GND	
VSS	Y11	GND	
VSS	Y33	GND	
VSS	Y36	GND	
VSS	Y41	GND	
VSS	Y6	GND	
VSS_SENSE	AR8	Analog	
VSS_SENSE_VTTD	AE37	Analog	
VTT_VID2	AV3	CMOS	O
VTT_VID3	AF7	CMOS	O
VTT_VID4	AV6	CMOS	O
VTTA	AD10	PWR	



**Table 4-1. Land Listing by Land Name  
(Sheet 35 of 36)**

Land Name	Land No.	Buffer Type	Direction
VTTA	AE10	PWR	
VTTA	AE11	PWR	
VTTA	AE33	PWR	
VTTA	AF11	PWR	
VTTA	AF33	PWR	
VTTA	AF34	PWR	
VTTA	AG34	PWR	
VTTD	AA10	PWR	
VTTD	AA11	PWR	
VTTD	AA33	PWR	
VTTD	AB10	PWR	
VTTD	AB11	PWR	
VTTD	AB33	PWR	
VTTD	AB34	PWR	
VTTD	AB8	PWR	
VTTD	AB9	PWR	
VTTD	AC10	PWR	

**Table 4-1. Land Listing by Land Name  
(Sheet 36 of 36)**

Land Name	Land No.	Buffer Type	Direction
VTTD	AC11	PWR	
VTTD	AC33	PWR	
VTTD	AC34	PWR	
VTTD	AC35	PWR	
VTTD	AD34	PWR	
VTTD	AD35	PWR	
VTTD	AD36	PWR	
VTTD	AD9	PWR	
VTTD	AE34	PWR	
VTTD	AE35	PWR	
VTTD	AE8	PWR	
VTTD	AE9	PWR	
VTTD	AF36	PWR	
VTTD	AF37	PWR	
VTTD	AF8	PWR	
VTTD	AF9	PWR	
VTTD_SENSE	AE36	Analog	
VTTPWGOOD	AB35	Asynch	I



### 4.1.2 Land Listing by Land Number

**Table 4-2. Land Listing by Land Number (Sheet 1 of 35)**

Land No.	Land Name	Buffer Type	Direction
A4	VSS	GND	
A5	BPM#[1]	GTL	I/O
A6	VSS	GND	
A7	DDR0_CS#[5]	CMOS	O
A8	DDR1_CS#[1]	CMOS	O
A9	VDDQ	PWR	
A10	DDR0_MA[13]	CMOS	O
A14	VDDQ	PWR	
A15	DDR0_RAS#	CMOS	O
A16	DDR0_BA[1]	CMOS	O
A17	DDR2_BA[0]	CMOS	O
A18	DDR2_MA[0]	CMOS	O
A19	VDDQ	PWR	
A20	DDR0_MA[0]	CMOS	O
A24	VDDQ	PWR	
A25	DDR0_MA[7]	CMOS	O
A26	DDR0_MA[11]	CMOS	O
A27	DDR0_PAR_ERR#[2]	Asynch	I
A28	DDR0_MA[14]	CMOS	O
A29	VDDQ	PWR	
A30	DDR0_CKE[1]	CMOS	O
A31	RSVD		
A35	VSS	GND	
A36	DDR0_ECC[1]	CMOS	I/O
A37	DDR0_ECC[5]	CMOS	I/O
A38	DDR0_DQ[26]	CMOS	I/O
A39	VSS	GND	
A40	RSVD		
A41	VSS	GND	
AA3	VSS	GND	
AA4	BCLK_ITP_DN	CMOS	O
AA5	BCLK_ITP_DP	CMOS	O
AA6	VDDPWRGOOD	Asynch	I
AA7	DDR1_DQ[62]	CMOS	I/O
AA8	DDR_COMP[0]	Analog	
AA9	VSS	GND	
AA10	VTTD	PWR	
AA11	VTTD	PWR	
AA33	VTTD	PWR	

**Table 4-2. Land Listing by Land Number (Sheet 2 of 35)**

Land No.	Land Name	Buffer Type	Direction
AA34	VSS	GND	
AA35	DDR1_DQ[4]	CMOS	I/O
AA36	DDR1_DQ[1]	CMOS	I/O
AA37	DDR1_DQ[0]	CMOS	I/O
AA38	VSS	GND	
AA39	VSS	GND	
AA40	DDR1_DQS_P[9]	CMOS	I/O
AA41	DDR1_DQS_N[9]	CMOS	I/O
AB3	QPI1_DTX_DN[13]	QPI	O
AB4	VSS	GND	
AB5	DDR_THERM#	CMOS	I
AB6	QPI1_DTX_DP[16]	QPI	O
AB7	VSS	GND	
AB8	VTTD	PWR	
AB9	VTTD	PWR	
AB10	VTTD	PWR	
AB11	VTTD	PWR	
AB33	VTTD	PWR	
AB34	VTTD	PWR	
AB35	VTTD	PWR	
AB36	DDR1_DQ[5]	CMOS	I/O
AB37	VSS	GND	
AB38	QPI0_DTX_DN[17]	QPI	O
AB39	QPI0_DTX_DP[17]	QPI	O
AB40	VSS	GND	
AB41	COMPO	Analog	
AB42	VSS	GND	
AB43	QPI0_DTX_DN[13]	QPI	O
AC1	DDR_COMP[2]	Analog	
AC2	VSS	GND	
AC3	QPI1_DTX_DP[13]	QPI	O
AC4	QPI1_DTX_DP[15]	QPI	O
AC5	VSS	GND	
AC6	QPI1_DTX_DN[16]	QPI	O
AC7	VSS	GND	
AC8	QPI1_DTX_DP[19]	QPI	O
AC9	VSS	GND	
AC10	VTTD	PWR	
AC11	VTTD	PWR	



**Table 4-2. Land Listing by Land Number (Sheet 3 of 35)**

Land No.	Land Name	Buffer Type	Direction
AC33	VTTD	PWR	
AC34	VTTD	PWR	
AC35	VTTD	PWR	
AC36	VSS	GND	
AC37	CAT_ERR#	GTL	I/O
AC38	QPI0_DTX_DN[16]	QPI	O
AC39	QPI0_DTX_DP[16]	QPI	O
AC40	QPI0_DTX_DN[15]	QPI	O
AC41	QPI0_DTX_DP[15]	QPI	O
AC42	QPI0_DTX_DN[12]	QPI	O
AC43	QPI0_DTX_DP[13]	QPI	O
AD1	QPI1_DTX_DN[11]	QPI	O
AD2	QPI1_DTX_DP[12]	QPI	O
AD3	QPI1_DTX_DN[12]	QPI	O
AD4	QPI1_DTX_DN[15]	QPI	O
AD5	QPI1_DTX_DP[18]	QPI	O
AD6	QPI1_DTX_DP[17]	QPI	O
AD7	QPI1_DTX_DN[17]	QPI	O
AD8	QPI1_DTX_DN[19]	QPI	O
AD9	VTTD	PWR	
AD10	VTTA	PWR	
AD11	VSS	GND	
AD33	VSS	GND	
AD34	VTTD	PWR	
AD35	VTTD	PWR	
AD36	VTTD	PWR	
AD37	VSS	GND	
AD38	QPI0_DTX_DP[18]	QPI	O
AD39	QPI0_DTX_DN[14]	QPI	O
AD40	QPI0_DTX_DP[14]	QPI	O
AD41	VSS	GND	
AD42	QPI0_DTX_DP[12]	QPI	O
AD43	VSS	GND	
AE1	QPI1_DTX_DP[11]	QPI	O
AE2	VSS	GND	
AE3	QPI1_DTX_DP[14]	QPI	O
AE4	QPI1_DTX_DN[14]	QPI	O
AE5	QPI1_DTX_DN[18]	QPI	O
AE6	QPI1_CLKTX_DN	QPI	O
AE7	VSS	GND	

**Table 4-2. Land Listing by Land Number (Sheet 4 of 35)**

Land No.	Land Name	Buffer Type	Direction
AE8	VTTD	PWR	
AE9	VTTD	PWR	
AE10	VTTA	PWR	
AE11	VTTA	PWR	
AE33	VTTA	PWR	
AE34	VTTD	PWR	
AE35	VTTD	PWR	
AE36	VTTD_SENSE	Analog	
AE37	VSS_SENSE_VTTD	Analog	
AE38	QPI0_DTX_DN[18]	QPI	O
AE39	VSS	GND	
AE40	QPI0_DTX_DP[19]	QPI	O
AE41	QPI0_DTX_DN[11]	QPI	O
AE42	QPI0_DTX_DP[11]	QPI	O
AE43	QPI0_DTX_DN[10]	QPI	O
AF1	RSVD		
AF2	QPI1_DTX_DP[10]	QPI	O
AF3	QPI1_DTX_DN[10]	QPI	O
AF4	RSVD		
AF5	VSS	GND	
AF6	QPI1_CLKTX_DP	QPI	O
AF7	VTT_VID3	CMOS	O
AF8	VTTD	PWR	
AF9	VTTD	PWR	
AF10	DBR#	Asynch	I
AF11	VTTA	PWR	
AF33	VTTA	PWR	
AF34	VTTA	PWR	
AF35	VSS	GND	
AF36	VTTD	PWR	
AF37	VTTD		
AF38	VSS	GND	
AF39	QPI0_DTX_DP[1]	QPI	O
AF40	QPI0_DTX_DN[19]	QPI	O
AF41	VSS	GND	
AF42	QPI0_CLKTX_DN	QPI	O
AF43	QPI0_DTX_DP[10]	QPI	O
AG1	RSVD		
AG2	QPI1_DTX_DN[9]	QPI	O
AG3	VSS	GND	


**Table 4-2. Land Listing by Land Number  
(Sheet 5 of 35)**

Land No.	Land Name	Buffer Type	Direction
AG4	RSVD		
AG5	RSVD		
AG6	QPI1_DTX_DN[5]	QPI	O
AG7	QPI1_DTX_DP[5]	QPI	O
AG8	QPI1_DTX_DP[0]	QPI	O
AG9	VSS	GND	
AG10	TMS	TAP	I
AG11	VSS	GND	
AG33	VSS	GND	
AG34	VTTA	PWR	
AG35	PROCHOT#	GTL	I/O
AG36	SKTOCC#	GTL	O
AG37	THERMTRIP#	GTL	O
AG38	QPIO_DTX_DP[0]	QPI	O
AG39	QPIO_DTX_DN[1]	QPI	O
AG40	QPIO_DTX_DP[9]	QPI	O
AG41	QPIO_DTX_DN[9]	QPI	O
AG42	QPIO_CLKTX_DP	QPI	O
AG43	VSS	GND	
AH1	VSS	GND	
AH2	QPI1_DTX_DP[9]	QPI	O
AH3	QPI1_DTX_DP[8]	QPI	O
AH4	QPI1_DTX_DN[8]	QPI	O
AH5	FC_AH5		
AH6	QPI1_DTX_DP[2]	QPI	O
AH7	VSS	GND	
AH8	QPI1_DTX_DN[0]	QPI	O
AH9	TRST#	TAP	I
AH10	TCK	TAP	I
AH11	VCC	PWR	
AH33	VCC	PWR	
AH34	VSS	GND	
AH35	BCLK_DN	CMOS	I
AH36	PECI	Asynch	I/O
AH37	VSS	GND	
AH38	QPIO_DTX_DN[0]	QPI	O
AH39	VSS	GND	
AH40	QPIO_DTX_DP[4]	QPI	O
AH41	QPIO_DTX_DP[6]	QPI	O
AH42	QPIO_DTX_DN[6]	QPI	O

**Table 4-2. Land Listing by Land Number  
(Sheet 6 of 35)**

Land No.	Land Name	Buffer Type	Direction
AH43	QPIO_DTX_DN[8]	QPI	O
AJ1	QPI1_DTX_DN[7]	QPI	O
AJ2	QPI1_DTX_DN[6]	QPI	O
AJ3	QPI1_DTX_DP[6]	QPI	O
AJ4	QPI1_DTX_DP[4]	QPI	O
AJ5	VSS	GND	
AJ6	QPI1_DTX_DN[2]	QPI	O
AJ7	QPI1_DTX_DN[1]	QPI	O
AJ8	QPI1_DTX_DP[1]	QPI	O
AJ9	TDI	TAP	I
AJ10	TDO	TAP	O
AJ11	VCC	PWR	
AJ33	VCC	PWR	
AJ34	VSS	GND	
AJ35	BCLK_DP	CMOS	I
AJ36	VSS	GND	
AJ37	GTLREF	Analog	I
AJ38	QPIO_DTX_DP[3]	QPI	O
AJ39	QPIO_DTX_DN[3]	QPI	O
AJ40	QPIO_DTX_DN[4]	QPI	O
AJ41	VSS	GND	
AJ42	QPIO_DTX_DN[7]	QPI	O
AJ43	QPIO_DTX_DP[8]	QPI	O
AK1	QPI1_DTX_DP[7]	QPI	O
AK2	RSVD		
AK3	VSS	GND	
AK4	QPI1_DTX_DN[4]	QPI	O
AK5	QPI1_DTX_DN[3]	QPI	O
AK6	QPI1_DTX_DP[3]	QPI	O
AK7	RSVD		
AK8	ISENSE	Analog	I
AK9	VSS	GND	
AK10	VSS	GND	
AK11	VCC	PWR	
AK12	VCC	PWR	
AK13	VCC	PWR	
AK14	VSS	GND	
AK15	VCC	PWR	
AK16	VCC	PWR	
AK17	VSS	GND	



**Table 4-2. Land Listing by Land Number (Sheet 7 of 35)**

Land No.	Land Name	Buffer Type	Direction
AK18	VCC	PWR	
AK19	VCC	PWR	
AK20	VSS	GND	
AK21	VCC	PWR	
AK22	VSS	GND	
AK23	VSS	GND	
AK24	VCC	PWR	
AK25	VCC	PWR	
AK26	VSS	GND	
AK27	VCC	PWR	
AK28	VCC	PWR	
AK29	VSS	GND	
AK30	VCC	PWR	
AK31	VCC	PWR	
AK32	VSS	GND	
AK33	VCC	PWR	
AK34	VSS	GND	
AK35	PECI_ID#	Asynch	I
AK36	RSVD		
AK37	QPI0_DTX_DP[2]	QPI	O
AK38	QPI0_DTX_DN[2]	QPI	O
AK39	VSS	GND	
AK40	QPI0_DTX_DP[5]	QPI	O
AK41	QPI0_DTX_DN[5]	QPI	O
AK42	QPI0_DTX_DP[7]	QPI	O
AK43	VSS	GND	
AL1	VSS	GND	
AL2	VSS	GND	
AL3	RSVD		
AL4	RSVD		
AL5	RSVD		
AL6	QPI1_COMP	Analog	
AL7	VSS	GND	
AL8	QPI1_DRX_DN[19]	QPI	I
AL9	VID[1]/MSID[1]	CMOS	O
AL10	VID[0]/MSID[0]	CMOS	O
AL11	VSS	GND	
AL12	VCC	PWR	
AL13	VCC	PWR	
AL14	VSS	GND	

**Table 4-2. Land Listing by Land Number (Sheet 8 of 35)**

Land No.	Land Name	Buffer Type	Direction
AL15	VCC	PWR	
AL16	VCC	PWR	
AL17	VSS	GND	
AL18	VCC	PWR	
AL19	VCC	PWR	
AL20	VSS	GND	
AL21	VCC	PWR	
AL22	VSS	GND	
AL23	VSS	GND	
AL24	VCC	PWR	
AL25	VCC	PWR	
AL26	VSS	GND	
AL27	VCC	PWR	
AL28	VCC	PWR	
AL29	VSS	GND	
AL30	VCC	PWR	
AL31	VCC	PWR	
AL32	VSS	GND	
AL33	VCC	PWR	
AL34	VCC	PWR	
AL35	VSS	GND	
AL36	VSS	GND	
AL37	VSS	GND	
AL38	RSVD		
AL39	RESET#	Asynch	I
AL40	RSVD		
AL41	RSVD		
AL42	VSS	GND	
AL43	QPI0_COMP	Analog	
AM1	QPI1_DRX_DN[13]	QPI	I
AM2	QPI1_DRX_DP[14]	QPI	I
AM3	QPI1_DRX_DN[14]	QPI	I
AM4	QPI1_DRX_DP[16]	QPI	I
AM5	VSS	GND	
AM6	QPI1_DRX_DP[18]	QPI	I
AM7	QPI1_DRX_DN[18]	QPI	I
AM8	QPI1_DRX_DP[19]	QPI	I
AM9	VSS	GND	
AM10	VID[3]/CSC[0]	CMOS	O
AM11	VSS	GND	



**Table 4-2. Land Listing by Land Number (Sheet 9 of 35)**

Land No.	Land Name	Buffer Type	Direction
AM12	VCC	PWR	
AM13	VCC	PWR	
AM14	VSS	GND	
AM15	VCC	PWR	
AM16	VCC	PWR	
AM17	VSS	GND	
AM18	VCC	PWR	
AM19	VCC	PWR	
AM20	VSS	GND	
AM21	VCC	PWR	
AM22	VSS	GND	
AM23	VSS	GND	
AM24	VCC	PWR	
AM25	VCC	PWR	
AM26	VSS	GND	
AM27	VCC	PWR	
AM28	VCC	PWR	
AM29	VSS	GND	
AM30	VCC	PWR	
AM31	VCC	PWR	
AM32	VSS	GND	
AM33	VCC	PWR	
AM34	VCC	PWR	
AM35	VSS	GND	
AM36	RSVD		
AM37	VSS	GND	
AM38	RSVD		
AM39	VSS	GND	
AM40	QPI0_DRX_DN[15]	QPI	I
AM41	QPI0_DRX_DN[16]	QPI	I
AM42	QPI0_DRX_DP[16]	QPI	I
AM43	QPI0_DRX_DN[14]	QPI	I
AN1	QPI1_DRX_DP[13]	QPI	I
AN2	QPI1_DRX_DN[12]	QPI	I
AN3	VSS	GND	
AN4	QPI1_DRX_DN[16]	QPI	I
AN5	QPI1_DRX_DP[17]	QPI	I
AN6	QPI1_DRX_DN[17]	QPI	I
AN7	VSS	GND	
AN8	VID[7]	CMOS	O

**Table 4-2. Land Listing by Land Number (Sheet 10 of 35)**

Land No.	Land Name	Buffer Type	Direction
AN9	VID[2]/MSID[2]	CMOS	O
AN10	VID[4]/CSC[1]	CMOS	O
AN11	VSS	GND	
AN12	VCC	PWR	
AN13	VCC	PWR	
AN14	VSS	GND	
AN15	VCC	PWR	
AN16	VCC	PWR	
AN17	VSS	GND	
AN18	VCC	PWR	
AN19	VCC	PWR	
AN20	VSS	GND	
AN21	VCC	PWR	
AN22	VSS	GND	
AN23	VSS	GND	
AN24	VCC	PWR	
AN25	VCC	PWR	
AN26	VSS	GND	
AN27	VCC	PWR	
AN28	VCC	PWR	
AN29	VSS	GND	
AN30	VCC	PWR	
AN31	VCC	PWR	
AN32	VSS	GND	
AN33	VCC	PWR	
AN34	VCC	PWR	
AN35	VSS	GND	
AN36	RSVD		
AN37	VSS	GND	
AN38	RSVD		
AN39	QPI0_DRX_DP[18]	QPI	I
AN40	QPI0_DRX_DP[15]	QPI	I
AN41	VSS	GND	
AN42	QPI0_DRX_DN[13]	QPI	I
AN43	QPI0_DRX_DP[14]	QPI	I
AP1	VSS	GND	
AP2	QPI1_DRX_DP[12]	QPI	I
AP3	QPI1_DRX_DP[15]	QPI	I
AP4	QPI1_DRX_DN[15]	QPI	I
AP5	VSS	GND	



**Table 4-2. Land Listing by Land Number (Sheet 11 of 35)**

Land No.	Land Name	Buffer Type	Direction
AP6	VSS	GND	
AP7	PSI#	CMOS	O
AP8	VID[6]	CMOS	O
AP9	VID[5]/CSC[2]	CMOS	O
AP10	VSS	GND	
AP11	VSS	GND	
AP12	VCC	PWR	
AP13	VCC	PWR	
AP14	VSS	GND	
AP15	VCC	PWR	
AP16	VCC	PWR	
AP17	VSS	GND	
AP18	VCC	PWR	
AP19	VCC	PWR	
AP20	VSS	GND	
AP21	VCC	PWR	
AP22	VSS	GND	
AP23	VSS	GND	
AP24	VCC	PWR	
AP25	VCC	PWR	
AP26	VSS	GND	
AP27	VCC	PWR	
AP28	VCC	PWR	
AP29	VSS	GND	
AP30	VCC	PWR	
AP31	VCC	PWR	
AP32	VSS	GND	
AP33	VCC	PWR	
AP34	VCC	PWR	
AP35	VSS	GND	
AP36	VSS	GND	
AP37	VSS	GND	
AP38	QPI0_DRX_DP[19]	QPI	I
AP39	QPI0_DRX_DN[18]	QPI	I
AP40	QPI0_DRX_DN[17]	QPI	I
AP41	QPI0_DRX_DP[17]	QPI	I
AP42	QPI0_DRX_DP[13]	QPI	I
AP43	VSS	GND	
AR1	QPI1_DRX_DN[10]	QPI	I
AR2	VSS	GND	

**Table 4-2. Land Listing by Land Number (Sheet 12 of 35)**

Land No.	Land Name	Buffer Type	Direction
AR3	VSS	GND	
AR4	QPI1_DRX_DP[11]	QPI	I
AR5	QPI1_DRX_DN[11]	QPI	I
AR6	QPI1_CLKRX_DN	QPI	I
AR7	VCCPWRGOOD	Asynch	I
AR8	VSS_SENSE	Analog	
AR9	VCC_SENSE	Analog	
AR10	VCC	PWR	
AR11	VSS	GND	
AR12	VCC	PWR	
AR13	VCC	PWR	
AR14	VSS	GND	
AR15	VCC	PWR	
AR16	VCC	PWR	
AR17	VSS	GND	
AR18	VCC	PWR	
AR19	VCC	PWR	
AR20	VSS	GND	
AR21	VCC	PWR	
AR22	VSS	GND	
AR23	VSS	GND	
AR24	VCC	PWR	
AR25	VCC	PWR	
AR26	VSS	GND	
AR27	VCC	PWR	
AR28	VCC	PWR	
AR29	VSS	GND	
AR30	VCC	PWR	
AR31	VCC	PWR	
AR32	VSS	GND	
AR33	VCC	PWR	
AR34	VCC	PWR	
AR35	VSS	GND	
AR36	RSVD		
AR37	RSVD		
AR38	QPI0_DRX_DN[19]	QPI	I
AR39	VSS	GND	
AR40	QPI0_DRX_DN[12]	QPI	I
AR41	QPI0_CLKRX_DP	QPI	I
AR42	QPI0_CLKRX_DN	QPI	I





**Table 4-2. Land Listing by Land Number (Sheet 13 of 35)**

Land No.	Land Name	Buffer Type	Direction
AR43	QPIO_DRX_DN[11]	QPI	I
AT1	QPI1_DRX_DP[10]	QPI	I
AT2	QPI1_DRX_DN[9]	QPI	I
AT3	QPI1_DRX_DP[9]	QPI	I
AT4	RSVD		
AT5	RSVD		
AT6	QPI1_CLKRX_DP	QPI	I
AT7	VSS	GND	
AT8	VSS	GND	
AT9	VCC	PWR	
AT10	VCC	PWR	
AT11	VSS	GND	
AT12	VCC	PWR	
AT13	VCC	PWR	
AT14	VSS	GND	
AT15	VCC	PWR	
AT16	VCC	PWR	
AT17	VSS	GND	
AT18	VCC	PWR	
AT19	VCC	PWR	
AT20	VSS	GND	
AT21	VCC	PWR	
AT22	VSS	GND	
AT23	VSS	GND	
AT24	VCC	PWR	
AT25	VCC	PWR	
AT26	VSS	GND	
AT27	VCC	PWR	
AT28	VCC	PWR	
AT29	VSS	GND	
AT30	VCC	PWR	
AT31	VCC	PWR	
AT32	VSS	GND	
AT33	VCC	PWR	
AT34	VCC	PWR	
AT35	VSS	GND	
AT36	RSVD		
AT37	QPIO_DRX_DP[0]	QPI	I
AT38	VSS	GND	
AT39	QPIO_DRX_DN[7]	QPI	I

**Table 4-2. Land Listing by Land Number (Sheet 14 of 35)**

Land No.	Land Name	Buffer Type	Direction
AT40	QPIO_DRX_DP[12]	QPI	I
AT41	VSS	GND	
AT42	QPIO_DRX_DN[10]	QPI	I
AT43	QPIO_DRX_DP[11]	QPI	I
AU1	VSS	GND	
AU2	RSVD		
AU3	QPI1_DRX_DN[8]	QPI	I
AU4	QPI1_DRX_DP[8]	QPI	I
AU5	VSS	GND	
AU6	QPI1_DRX_DN[6]	QPI	I
AU7	QPI1_DRX_DP[6]	QPI	I
AU8	QPI1_DRX_DP[0]	QPI	I
AU9	VCC	PWR	
AU10	VCC	PWR	
AU11	VSS	GND	
AU12	VCC	PWR	
AU13	VCC	PWR	
AU14	VSS	GND	
AU15	VCC	PWR	
AU16	VCC	PWR	
AU17	VSS	GND	
AU18	VCC	PWR	
AU19	VCC	PWR	
AU20	VSS	GND	
AU21	VCC	PWR	
AU22	VSS	GND	
AU23	VSS	GND	
AU24	VCC	PWR	
AU25	VCC	PWR	
AU26	VSS	GND	
AU27	VCC	PWR	
AU28	VCC	PWR	
AU29	VSS	GND	
AU30	VCC	PWR	
AU31	VCC	PWR	
AU32	VSS	GND	
AU33	VCC	PWR	
AU34	VCC	PWR	
AU35	VSS	GND	
AU36	VSS	GND	



**Table 4-2. Land Listing by Land Number (Sheet 15 of 35)**

Land No.	Land Name	Buffer Type	Direction
AU37	QPI0_DRX_DN[0]	QPI	I
AU38	QPI0_DRX_DP[1]	QPI	I
AU39	QPI0_DRX_DP[7]	QPI	I
AU40	QPI0_DRX_DP[9]	QPI	I
AU41	QPI0_DRX_DN[9]	QPI	I
AU42	QPI0_DRX_DP[10]	QPI	I
AU43	VSS	GND	
AV1	RSVD		
AV2	RSVD		
AV3	VTT_VID2	CMOS	O
AV4	VSS	GND	
AV5	QPI1_DRX_DP[3]	QPI	I
AV6	VTT_VID4	CMOS	O
AV7	QPI1_DRX_DP[1]	QPI	I
AV8	QPI1_DRX_DN[0]	QPI	I
AV9	VCC	PWR	
AV10	VCC	PWR	
AV11	VSS	GND	
AV12	VCC	PWR	
AV13	VCC	PWR	
AV14	VSS	GND	
AV15	VCC	PWR	
AV16	VCC	PWR	
AV17	VSS	GND	
AV18	VCC	PWR	
AV19	VCC	PWR	
AV20	VSS	GND	
AV21	VCC	PWR	
AV22	VSS	GND	
AV23	VSS	GND	
AV24	VCC	PWR	
AV25	VCC	PWR	
AV26	VSS	GND	
AV27	VCC	PWR	
AV28	VCC	PWR	
AV29	VSS	GND	
AV30	VCC	PWR	
AV31	VCC	PWR	
AV32	VSS	GND	
AV33	VCC	PWR	

**Table 4-2. Land Listing by Land Number (Sheet 16 of 35)**

Land No.	Land Name	Buffer Type	Direction
AV34	VCC	PWR	
AV35	RSVD		
AV36	QPI0_DRX_DP[2]	QPI	I
AV37	QPI0_DRX_DN[2]	QPI	I
AV38	QPI0_DRX_DN[1]	QPI	I
AV39	VSS	GND	
AV40	QPI0_DRX_DN[8]	QPI	I
AV41	VSS	GND	
AV42	RSVD		
AV43	RSVD		
AW1	VSS	GND	
AW2	RSVD		
AW3	QPI1_DRX_DN[7]	QPI	I
AW4	QPI1_DRX_DP[7]	QPI	I
AW5	QPI1_DRX_DN[3]	QPI	I
AW6	VSS	GND	
AW7	QPI1_DRX_DN[1]	QPI	I
AW8	VSS	GND	
AW9	VCC	PWR	
AW10	VCC	PWR	
AW11	VSS	GND	
AW12	VCC	PWR	
AW13	VCC	PWR	
AW14	VSS	GND	
AW15	VCC	PWR	
AW16	VCC	PWR	
AW17	VSS	GND	
AW18	VCC	PWR	
AW19	VCC	PWR	
AW20	VSS	GND	
AW21	VCC	PWR	
AW22	VSS	GND	
AW23	VSS	GND	
AW24	VCC	PWR	
AW25	VCC	PWR	
AW26	VSS	GND	
AW27	VCC	PWR	
AW28	VCC	PWR	
AW29	VSS	GND	
AW30	VCC	PWR	



**Table 4-2. Land Listing by Land Number  
(Sheet 17 of 35)**

Land No.	Land Name	Buffer Type	Direction
AW31	VCC	PWR	
AW32	VSS	GND	
AW33	VCC	PWR	
AW34	VCC	PWR	
AW35	VSS	GND	
AW36	QPI0_DRX_DP[3]	QPI	I
AW37	QPI0_DRX_DP[5]	QPI	I
AW38	QPI0_DRX_DN[5]	QPI	I
AW39	RSVD		
AW40	QPI0_DRX_DP[8]	QPI	I
AW41	RSVD		
AW42	RSVD		
AY2	VSS	GND	
AY3	RSVD		
AY4	RSVD		
AY5	QPI1_DRX_DN[5]	QPI	I
AY6	QPI1_DRX_DP[5]	QPI	I
AY7	VSS	GND	
AY8	QPI1_DRX_DP[2]	QPI	I
AY9	VCC	PWR	
AY10	VCC	PWR	
AY11	VSS	GND	
AY12	VCC	PWR	
AY13	VCC	PWR	
AY14	VSS	GND	
AY15	VCC	PWR	
AY16	VCC	PWR	
AY17	VSS	GND	
AY18	VCC	PWR	
AY19	VCC	PWR	
AY20	VSS	GND	
AY21	VCC	PWR	
AY22	VSS	GND	
AY23	VSS	GND	
AY24	VCC	PWR	
AY25	VCC	PWR	
AY26	VSS	GND	
AY27	VCC	PWR	
AY28	VCC	PWR	
AY29	VSS	GND	

**Table 4-2. Land Listing by Land Number  
(Sheet 18 of 35)**

Land No.	Land Name	Buffer Type	Direction
AY30	VCC	PWR	
AY31	VCC	PWR	
AY32	VSS	GND	
AY33	VCC	PWR	
AY34	VCC	PWR	
AY35	RSVD		
AY36	QPI0_DRX_DN[3]	QPI	I
AY37	VSS	GND	
AY38	QPI0_DRX_DN[6]	QPI	I
AY39	RSVD		
AY40	RSVD		
AY41	RSVD		
AY42	VSS	GND	
B2	VSS	GND	
B3	BPM#[0]	GTL	I/O
B4	BPM#[3]	GTL	I/O
B5	DDR0_DQ[32]	CMOS	I/O
B6	DDR0_DQ[36]	CMOS	I/O
B7	VDDQ	PWR	
B8	DDR0_CS#[7]/ DDR0_ODT[5]	CMOS	O
B9	DDR0_CS#[3]	CMOS	O
B10	DDR0_CS#[1]	CMOS	O
B11	DDR0_ODT[2]	CMOS	O
B12	VDDQ	PWR	
B13	DDR0_WE#	CMOS	O
B14	DDR1_MA[13]	CMOS	O
B15	DDR0_CS#[4]	CMOS	O
B16	DDR0_BA[0]	CMOS	O
B17	VDDQ	PWR	
B18	DDR2_MA_PAR	CMOS	O
B19	DDR0_MA[10]	CMOS	O
B20	DDR0_MA_PAR	CMOS	O
B21	DDR0_MA[1]	CMOS	O
B22	VDDQ	PWR	
B23	DDR0_MA[4]	CMOS	O
B24	DDR0_MA[5]	CMOS	O
B25	DDR0_MA[8]	CMOS	O
B26	DDR0_MA[12]	CMOS	O
B27	VDDQ	PWR	
B28	DDR0_PAR_ERR#[1]	Asynch	I



**Table 4-2. Land Listing by Land Number (Sheet 19 of 35)**

Land No.	Land Name	Buffer Type	Direction
B29	DDR0_MA[15]	CMOS	O
B30	DDR0_CKE[2]	CMOS	O
B31	DDR0_CKE[3]	CMOS	O
B32	VDDQ	PWR	
B33	RSVD		
B34	DDR0_ECC[6]	CMOS	I/O
B35	DDR0_DQS_N[17]	CMOS	I/O
B36	DDR0_DQS_P[17]	CMOS	I/O
B37	VSS	GND	
B38	DDR0_DQ[31]	CMOS	I/O
B39	DDR0_DQS_P[3]	CMOS	I/O
B40	DDR0_DQS_N[3]	CMOS	I/O
B41	PRDY#	GTL	O
B42	VSS	GND	
BA3	VSS	GND	
BA4	RSVD		
BA5	VSS	GND	
BA6	QPI1_DRX_DN[4]	QPI	I
BA7	QPI1_DRX_DP[4]	QPI	I
BA8	QPI1_DRX_DN[2]	QPI	I
BA9	VCC	PWR	
BA10	VCC	PWR	
BA11	VSS	GND	
BA12	VCC	PWR	
BA13	VCC	PWR	
BA14	VSS	GND	
BA15	VCC	PWR	
BA16	VCC	PWR	
BA17	VSS	GND	
BA18	VCC	PWR	
BA19	VCC	PWR	
BA20	VSS	GND	
BA24	VCC	PWR	
BA25	VCC	PWR	
BA26	VSS	GND	
BA27	VCC	PWR	
BA28	VCC	PWR	
BA29	VSS	GND	
BA30	VCC	PWR	
BA35	VSS	GND	

**Table 4-2. Land Listing by Land Number (Sheet 20 of 35)**

Land No.	Land Name	Buffer Type	Direction
BA36	QPI0_DRX_DP[4]	QPI	I
BA37	QPI0_DRX_DN[4]	QPI	I
BA38	QPI0_DRX_DP[6]	QPI	I
BA39	VSS	GND	
BA40	RSVD		
C2	BPM#[2]	GTL	I/O
C3	BPM#[5]	GTL	I/O
C4	DDR0_DQ[33]	CMOS	I/O
C5	VSS	GND	
C6	DDR0_DQ[37]	CMOS	I/O
C7	DDR0_ODT[3]	CMOS	O
C8	DDR1_ODT[1]	CMOS	O
C9	DDR0_ODT[1]	CMOS	O
C10	VDDQ	PWR	
C11	DDR0_CS#[6]/ DDR0_ODT[4]	CMOS	O
C12	DDR0_CAS#	CMOS	O
C13	DDR0_CS#[2]	CMOS	O
C14	DDR1_CS#[6]/ DDR1_ODT[4]	CMOS	O
C15	VDDQ	PWR	
C16	DDR2_WE#	CMOS	O
C17	DDR1_CS#[4]	CMOS	O
C18	DDR1_BA[0]	CMOS	O
C19	DDR0_CLK_N[1]	CLOCK	O
C20	VDDQ	PWR	
C21	DDR1_CLK_P[0]	CLOCK	O
C22	DDR1_PAR_ERR#[0]	Asynch	I
C23	DDR0_MA[2]	CMOS	O
C24	DDR0_MA[6]	CMOS	O
C25	VDDQ	PWR	
C26	DDR0_MA[9]	CMOS	O
C27	DDR1_CKE[3]	CMOS	O
C28	DDR0_BA[2]	CMOS	O
C29	DDR0_CKE[0]	CMOS	O
C30	VDDQ	PWR	
C31	RSVD		
C32	RSVD		
C33	DDR0_ECC[3]	CMOS	I/O
C34	DDR0_ECC[7]	CMOS	I/O
C35	VSS	GND	


**Table 4-2. Land Listing by Land Number  
(Sheet 21 of 35)**

Land No.	Land Name	Buffer Type	Direction
C36	DDR0_ECC[0]	CMOS	I/O
C37	DDR0_ECC[4]	CMOS	I/O
C38	DDR0_DQ[30]	CMOS	I/O
C39	DDR0_DQS_N[12]	CMOS	I/O
C40	VSS	GND	
C41	DDR0_DQ[25]	CMOS	I/O
C42	PREQ#	GTL	I
C43	VSS	GND	
D1	BPM#[4]	GTL	I/O
D2	BPM#[6]	GTL	I/O
D3	VSS	GND	
D4	DDR0_DQS_N[13]	CMOS	I/O
D5	DDR0_DQS_P[13]	CMOS	I/O
D6	DDR1_DQ[38]	CMOS	I/O
D7	DDR1_DQS_N[4]	CMOS	I/O
D8	VSS	GND	
D9	DDR2_CS#[5]	CMOS	O
D10	DDR2_ODT[3]	CMOS	O
D11	DDR1_ODT[0]	CMOS	O
D12	DDR1_CS#[0]	CMOS	O
D13	VDDQ	PWR	
D14	DDR1_ODT[2]	CMOS	O
D15	DDR2_ODT[2]	CMOS	O
D16	DDR2_CS#[2]	CMOS	O
D17	DDR2_RAS#	CMOS	O
D18	VDDQ	PWR	
D19	DDR0_CLK_P[1]	CLOCK	O
D20	DDR1_MA_PAR	CMOS	O
D21	DDR1_CLK_N[0]	CLOCK	O
D22	DDR1_MA[7]	CMOS	O
D23	VDDQ	PWR	
D24	DDR0_MA[3]	CMOS	O
D25	DDR0_PAR_ERR#[0]	Asynch	I
D26	DDR2_CKE[2]	CMOS	O
D27	DDR1_CKE[2]	CMOS	O
D28	VDDQ	PWR	
D29	DDR1_RESET#	CMOS	O
D30	RSVD		
D31	RSVD		
D32	DDR0_RESET#	CMOS	O

**Table 4-2. Land Listing by Land Number  
(Sheet 22 of 35)**

Land No.	Land Name	Buffer Type	Direction
D33	VSS	GND	
D34	DDR0_DQS_P[8]	CMOS	I/O
D35	DDR0_DQS_N[8]	CMOS	I/O
D36	DDR1_ECC[0]	CMOS	I/O
D37	DDR0_DQ[27]	CMOS	I/O
D38	VSS	GND	
D39	DDR0_DQS_P[12]	CMOS	I/O
D40	DDR0_DQ[24]	CMOS	I/O
D41	DDR0_DQ[28]	CMOS	I/O
D42	DDR0_DQ[29]	CMOS	I/O
D43	VSS	GND	
E1	VSS	GND	
E2	BPM#[7]	GTL	I/O
E3	DDR0_DQS_P[4]	CMOS	I/O
E4	DDR0_DQS_N[4]	CMOS	I/O
E5	DDR1_DQ[34]	CMOS	I/O
E6	VSS	GND	
E7	DDR1_DQS_P[4]	CMOS	I/O
E8	DDR1_DQ[33]	CMOS	I/O
E9	DDR1_DQ[32]	CMOS	I/O
E10	DDR1_CS#[5]	CMOS	O
E11	VDDQ	PWR	
E12	DDR1_CS#[7]/ DDR1_ODT[5]	CMOS	O
E13	DDR1_CS#[3]	CMOS	O
E14	DDR1_CAS#	CMOS	O
E15	DDR1_CS#[2]	CMOS	O
E16	VDDQ	PWR	
E17	DDR2_CS#[4]	CMOS	O
E18	DDR0_CLK_N[2]	CLOCK	O
E19	DDR0_CLK_N[3]	CLOCK	O
E20	DDR0_CLK_P[3]	CLOCK	O
E21	VDDQ	PWR	
E22	DDR1_MA[8]	CMOS	O
E23	DDR1_MA[11]	CMOS	O
E24	DDR1_MA[12]	CMOS	O
E25	DDR1_PAR_ERR#[1]	Asynch	I
E26	VDDQ	PWR	
E27	DDR1_CKE[1]	CMOS	O
E28	RSVD		
E29	DDR2_ECC[2]	CMOS	I/O

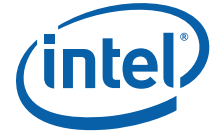


**Table 4-2. Land Listing by Land Number (Sheet 23 of 35)**

Land No.	Land Name	Buffer Type	Direction
E30	DDR2_ECC[3]	CMOS	I/O
E31	VDDQ	PWR	
E32	DDR2_RESET#	CMOS	O
E33	DDR1_ECC[2]	CMOS	I/O
E34	DDR1_ECC[6]	CMOS	I/O
E35	DDR1_DQS_N[17]	CMOS	I/O
E36	VSS	GND	
E37	DDR1_ECC[4]	CMOS	I/O
E38	DDR2_DQ[31]	CMOS	I/O
E39	DDR2_DQS_P[3]	CMOS	I/O
E40	DDR2_DQS_N[3]	CMOS	I/O
E41	VSS	GND	
E42	DDR0_DQ[18]	CMOS	I/O
E43	DDR0_DQ[19]	CMOS	I/O
F1	DDR0_DQ[34]	CMOS	I/O
F2	DDR0_DQ[39]	CMOS	I/O
F3	DDR0_DQ[38]	CMOS	I/O
F4	VSS	GND	
F5	DDR1_DQ[35]	CMOS	I/O
F6	DDR1_DQ[39]	CMOS	I/O
F7	DDR1_DQS_N[13]	CMOS	I/O
F8	DDR1_DQS_P[13]	CMOS	I/O
F9	VSS	GND	
F10	DDR1_DQ[36]	CMOS	I/O
F11	DDR1_ODT[3]	CMOS	O
F12	DDR0_ODT[0]	CMOS	O
F13	DDR2_ODT[1]	CMOS	O
F14	VDDQ	PWR	
F15	DDR2_MA[13]	CMOS	O
F16	DDR2_CAS#	CMOS	O
F17	DDR2_BA[1]	CMOS	O
F18	DDR0_CLK_P[2]	CLOCK	O
F19	VDDQ	PWR	
F20	DDR2_MA[4]	CMOS	O
F21	DDR2_PAR_ERR#[0]	Asynch	I
F22	DDR1_MA[5]	CMOS	O
F23	DDR2_PAR_ERR#[2]	Asynch	I
F24	VDDQ	PWR	
F25	DDR1_PAR_ERR#[2]	Asynch	I
F26	DDR1_MA[15]	CMOS	O

**Table 4-2. Land Listing by Land Number (Sheet 24 of 35)**

Land No.	Land Name	Buffer Type	Direction
F27	RSVD		
F28	RSVD		
F29	VSS	GND	
F30	DDR2_ECC[7]	CMOS	I/O
F31	DDR2_ECC[6]	CMOS	I/O
F32	DDR0_ECC[2]	CMOS	I/O
F33	DDR2_ECC[1]	CMOS	I/O
F34	VSS	GND	
F35	DDR1_DQS_P[17]	CMOS	I/O
F36	DDR1_ECC[1]	CMOS	I/O
F37	DDR1_ECC[5]	CMOS	I/O
F38	DDR2_DQ[30]	CMOS	I/O
F39	VSS	GND	
F40	DDR2_DQ[25]	CMOS	I/O
F41	DDR0_DQS_P[2]	CMOS	I/O
F42	DDR0_DQ[23]	CMOS	I/O
F43	DDR0_DQ[22]	CMOS	I/O
G1	DDR0_DQ[44]	CMOS	I/O
G2	VSS	GND	
G3	DDR0_DQ[35]	CMOS	I/O
G4	DDR1_DQ[42]	CMOS	I/O
G5	DDR1_DQ[46]	CMOS	I/O
G6	DDR1_DQS_N[5]	CMOS	I/O
G7	VSS	GND	
G8	DDR1_DQ[37]	CMOS	I/O
G9	DDR1_DQ[44]	CMOS	I/O
G10	DDR2_DQ[37]	CMOS	I/O
G11	DDR2_DQ[36]	CMOS	I/O
G12	VSS	GND	
G13	DDR1_WE#	CMOS	O
G14	DDR1_RAS#	CMOS	O
G15	DDR0_CS#[0]	CMOS	O
G16	DDR2_CS#[0]	CMOS	O
G17	VDDQ	PWR	
G18	DDR2_MA[2]	CMOS	O
G19	DDR1_CLK_P[1]	CLOCK	O
G20	DDR1_CLK_N[1]	CLOCK	O
G21	DDR2_CLK_N[2]	CLOCK	O
G22	VDDQ	PWR	
G23	DDR2_MA[12]	CMOS	O



**Table 4-2. Land Listing by Land Number (Sheet 25 of 35)**

Land No.	Land Name	Buffer Type	Direction
G24	DDR1_MA[9]	CMOS	O
G25	DDR2_MA[15]	CMOS	O
G26	DDR2_CKE[1]	CMOS	O
G27	VDDQ	PWR	
G28	RSVD		
G29	DDR2_DQS_P[8]	CMOS	I/O
G30	DDR2_DQS_N[8]	CMOS	I/O
G31	DDR2_DQS_N[17]	CMOS	I/O
G32	VSS	GND	
G33	DDR1_DQS_P[8]	CMOS	I/O
G34	DDR1_DQS_N[8]	CMOS	I/O
G35	DDR1_ECC[7]	CMOS	I/O
G36	DDR1_ECC[3]	CMOS	I/O
G37	VSS	GND	
G38	DDR2_DQS_N[12]	CMOS	I/O
G39	DDR2_DQ[29]	CMOS	I/O
G40	DDR2_DQ[24]	CMOS	I/O
G41	DDR0_DQS_N[2]	CMOS	I/O
G42	VSS	GND	
G43	DDR0_DQS_N[11]	CMOS	I/O
H1	DDR0_DQ[41]	CMOS	I/O
H2	DDR0_DQ[40]	CMOS	I/O
H3	DDR0_DQ[45]	CMOS	I/O
H4	DDR1_DQ[43]	CMOS	I/O
H5	VSS	GND	
H6	DDR1_DQS_P[5]	CMOS	I/O
H7	DDR1_DQS_P[14]	CMOS	I/O
H8	DDR1_DQ[40]	CMOS	I/O
H9	DDR1_DQ[45]	CMOS	I/O
H10	VSS	GND	
H11	DDR2_DQS_P[13]	CMOS	I/O
H12	DDR2_DQ[38]	CMOS	I/O
H13	DDR2_DQ[34]	CMOS	I/O
H14	DDR1_MA[10]	CMOS	O
H15	VDDQ	PWR	
H16	DDR2_CS#[3]	CMOS	O
H17	DDR2_MA[10]	CMOS	O
H18	DDR1_CLK_P[3]	CLOCK	O
H19	DDR1_CLK_N[3]	CLOCK	O
H20	VDDQ	PWR	

**Table 4-2. Land Listing by Land Number (Sheet 26 of 35)**

Land No.	Land Name	Buffer Type	Direction
H21	DDR2_CLK_P[2]	CLOCK	O
H22	DDR2_MA[9]	CMOS	O
H23	DDR2_MA[11]	CMOS	O
H24	DDR2_MA[14]	CMOS	O
H25	VDDQ	PWR	
H26	DDR1_MA[14]	CMOS	O
H27	DDR1_BA[2]	CMOS	O
H28	DDR1_CKE[0]	CMOS	O
H29	RSVD		
H30	VSS	GND	
H31	DDR2_DQS_P[17]	CMOS	I/O
H32	DDR2_ECC[0]	CMOS	I/O
H33	DDR1_DQ[24]	CMOS	I/O
H34	DDR1_DQ[29]	CMOS	I/O
H35	VSS	GND	
H36	DDR1_DQ[23]	CMOS	I/O
H37	DDR2_DQ[27]	CMOS	I/O
H38	DDR2_DQS_P[12]	CMOS	I/O
H39	DDR2_DQ[28]	CMOS	I/O
H40	VSS	GND	
H41	DDR0_DQ[16]	CMOS	I/O
H42	DDR0_DQS_P[11]	CMOS	I/O
H43	DDR0_DQ[17]	CMOS	I/O
J1	DDR0_DQS_N[14]	CMOS	I/O
J2	DDR0_DQS_P[14]	CMOS	I/O
J3	VSS	GND	
J4	DDR1_DQ[52]	CMOS	I/O
J5	DDR1_DQ[47]	CMOS	I/O
J6	DDR1_DQ[41]	CMOS	I/O
J7	DDR1_DQS_N[14]	CMOS	I/O
J8	VSS	GND	
J9	DDR2_DQS_N[4]	CMOS	I/O
J10	DDR2_DQS_P[4]	CMOS	I/O
J11	DDR2_DQS_N[13]	CMOS	I/O
J12	DDR2_DQ[33]	CMOS	I/O
J13	VSS	GND	
J14	DDR1_MA[0]	CMOS	O
J15	DDR2_CS#[7]/ DDR2_ODT[5]	CMOS	O
J16	DDR1_MA[1]	CMOS	O
J17	DDR1_MA[2]	CMOS	O



**Table 4-2. Land Listing by Land Number (Sheet 27 of 35)**

Land No.	Land Name	Buffer Type	Direction
J18	VDDQ	PWR	
J19	DDR0_CLK_P[0]	CLOCK	O
J20	DDR2_MA[3]	CMOS	O
J21	DDR2_CLK_N[0]	CLOCK	O
J22	DDR2_CLK_P[0]	CLOCK	O
J23	VDDQ	PWR	
J24	DDR2_MA[7]	CMOS	O
J25	DDR2_PAR_ERR#[1]	Asynch	I
J26	DDR2_CKE[0]	CMOS	O
J27	DDR1_MA[6]	CMOS	O
J28	VDDQ	PWR	
J29	RSVD		
J30	DDR2_ECC[5]	CMOS	I/O
J31	DDR2_ECC[4]	CMOS	I/O
J32	DDR1_DQ[27]	CMOS	I/O
J33	VSS	GND	
J34	DDR1_DQ[28]	CMOS	I/O
J35	DDR1_DQ[19]	CMOS	I/O
J36	DDR1_DQ[22]	CMOS	I/O
J37	DDR2_DQ[26]	CMOS	I/O
J38	VSS	GND	
J39	DDR2_DQ[19]	CMOS	I/O
J40	DDR2_DQ[18]	CMOS	I/O
J41	DDR0_DQ[21]	CMOS	I/O
J42	DDR0_DQ[20]	CMOS	I/O
J43	VSS	GND	
K1	VSS	GND	
K2	DDR0_DQS_P[5]	CMOS	I/O
K3	DDR0_DQS_N[5]	CMOS	I/O
K4	DDR1_DQ[48]	CMOS	I/O
K5	DDR1_DQ[49]	CMOS	I/O
K6	VSS	GND	
K7	DDR2_DQS_N[5]	CMOS	I/O
K8	DDR2_DQS_N[14]	CMOS	I/O
K9	DDR2_DQS_P[14]	CMOS	I/O
K10	DDR2_DQ[41]	CMOS	I/O
K11	VSS	GND	
K12	DDR2_DQ[32]	CMOS	I/O
K13	DDR1_BA[1]	CMOS	O
K14	DDR2_CS#[1]	CMOS	O

**Table 4-2. Land Listing by Land Number (Sheet 28 of 35)**

Land No.	Land Name	Buffer Type	Direction
K15	RSVD		
K16	VDDQ	PWR	
K17	DDR2_MA[1]	CMOS	O
K18	DDR1_CLK_P[2]	CLOCK	O
K19	DDR0_CLK_N[0]	CLOCK	O
K20	DDR2_CLK_N[1]	CLOCK	O
K21	VDDQ	PWR	
K22	DDR2_MA[6]	CMOS	O
K23	DDR2_MA[5]	CMOS	O
K24	RSVD		
K25	RSVD		
K26	VDDQ	PWR	
K27	RSVD		
K28	DDR1_MA[4]	CMOS	O
K29	RSVD		
K30	DDR1_DQ[31]	CMOS	I/O
K31	VSS	GND	
K32	DDR1_DQ[26]	CMOS	I/O
K33	DDR1_DQS_N[12]	CMOS	I/O
K34	DDR1_DQS_P[12]	CMOS	I/O
K35	DDR1_DQ[18]	CMOS	I/O
K36	VSS	GND	
K37	DDR1_DQS_N[11]	CMOS	I/O
K38	DDR2_DQ[23]	CMOS	I/O
K39	DDR2_DQS_N[2]	CMOS	I/O
K40	DDR2_DQS_P[2]	CMOS	I/O
K41	VSS	GND	
K42	DDR0_DQ[10]	CMOS	I/O
K43	DDR0_DQ[11]	CMOS	I/O
L1	DDR0_DQ[42]	CMOS	I/O
L2	DDR0_DQ[47]	CMOS	I/O
L3	DDR0_DQ[46]	CMOS	I/O
L4	VSS	GND	
L5	DDR1_DQS_N[6]	CMOS	I/O
L6	DDR1_DQS_P[6]	CMOS	I/O
L7	DDR2_DQS_P[5]	CMOS	I/O
L8	DDR2_DQ[46]	CMOS	I/O
L9	VSS	GND	
L10	DDR2_DQ[40]	CMOS	I/O
L11	DDR2_DQ[44]	CMOS	I/O





**Table 4-2. Land Listing by Land Number (Sheet 29 of 35)**

Land No.	Land Name	Buffer Type	Direction
L12	DDR2_DQ[39]	CMOS	I/O
L13	DDR2_DQ[35]	CMOS	I/O
L14	VDDQ	PWR	
L15	RSVD		
L16	DDR2_ODT[0]	CMOS	O
L17	DDR2_CS#[6]/ DDR2_ODT[4]	CMOS	O
L18	DDR1_CLK_N[2]	CLOCK	O
L19	VDDQ	PWR	
L20	DDR2_CLK_P[1]	CLOCK	O
L21	DDR2_CLK_N[3]	CLOCK	O
L22	DDR2_CLK_P[3]	CLOCK	O
L23	DDR_VREF	Analog	I
L24	VDDQ	PWR	
L25	DDR2_MA[8]	CMOS	O
L26	DDR2_BA[2]	CMOS	O
L27	DDR2_CKE[3]	CMOS	O
L28	DDR1_MA[3]	CMOS	O
L29	VSS	GND	
L30	DDR1_DQS_P[3]	CMOS	I/O
L31	DDR1_DQS_N[3]	CMOS	I/O
L32	DDR1_DQ[30]	CMOS	I/O
L33	DDR1_DQ[25]	CMOS	I/O
L34	VSS	GND	
L35	DDR1_DQS_P[2]	CMOS	I/O
L36	DDR1_DQS_N[2]	CMOS	I/O
L37	DDR1_DQS_P[11]	CMOS	I/O
L38	DDR2_DQS_N[11]	CMOS	I/O
L39	VSS	GND	
L40	DDR2_DQ[22]	CMOS	I/O
L41	DDR0_DQS_P[1]	CMOS	I/O
L42	DDR0_DQ[15]	CMOS	I/O
L43	DDR0_DQ[14]	CMOS	I/O
M1	DDR0_DQ[43]	CMOS	I/O
M2	VSS	GND	
M3	DDR0_DQ[52]	CMOS	I/O
M4	DDR1_DQS_N[15]	CMOS	I/O
M5	DDR1_DQS_P[15]	CMOS	I/O
M6	DDR1_DQ[53]	CMOS	I/O
M7	VSS	GND	
M8	DDR2_DQ[47]	CMOS	I/O

**Table 4-2. Land Listing by Land Number (Sheet 30 of 35)**

Land No.	Land Name	Buffer Type	Direction
M9	DDR2_DQ[42]	CMOS	I/O
M10	DDR2_DQ[45]	CMOS	I/O
M11	VCC	PWR	
M12	VSS	GND	
M13	VCC	PWR	
M14	VSS	GND	
M15	VCC	PWR	
M16	VSS	GND	
M17	VDDQ	PWR	
M18	VSS	GND	
M19	VCC	PWR	
M20	VSS	GND	
M21	VCC	PWR	
M22	VSS	GND	
M23	VCC	PWR	
M24	VSS	GND	
M25	VCC	PWR	
M26	VSS	GND	
M27	VDDQ	PWR	
M28	VSS	GND	
M29	VCC	PWR	
M30	VSS	GND	
M31	VCC	PWR	
M32	VSS	GND	
M33	VCC	PWR	
M34	DDR1_DQ[17]	CMOS	I/O
M35	DDR1_DQ[16]	CMOS	I/O
M36	DDR1_DQ[21]	CMOS	I/O
M37	VSS	GND	
M38	DDR2_DQS_P[11]	CMOS	I/O
M39	DDR2_DQ[16]	CMOS	I/O
M40	DDR2_DQ[17]	CMOS	I/O
M41	DDR0_DQS_N[1]	CMOS	I/O
M42	VSS	GND	
M43	DDR0_DQS_N[10]	CMOS	I/O
N1	DDR0_DQ[48]	CMOS	I/O
N2	DDR0_DQ[49]	CMOS	I/O
N3	DDR0_DQ[53]	CMOS	I/O
N4	DDR2_DQS_P[15]	CMOS	I/O
N5	VSS	GND	



**Table 4-2. Land Listing by Land Number (Sheet 31 of 35)**

Land No.	Land Name	Buffer Type	Direction
N6	DDR2_DQ[49]	CMOS	I/O
N7	DDR2_DQ[53]	CMOS	I/O
N8	DDR2_DQ[52]	CMOS	I/O
N9	DDR2_DQ[43]	CMOS	I/O
N10	VSS	GND	
N11	VCC	PWR	
N33	VCC	PWR	
N34	DDR1_DQ[20]	CMOS	I/O
N35	VSS	GND	
N36	DDR2_DQ[21]	CMOS	I/O
N37	DDR1_DQ[14]	CMOS	I/O
N38	DDR1_DQ[15]	CMOS	I/O
N39	DDR1_DQ[11]	CMOS	I/O
N40	VSS	GND	
N41	DDR0_DQ[8]	CMOS	I/O
N42	DDR0_DQS_P[10]	CMOS	I/O
N43	DDR0_DQ[9]	CMOS	I/O
P1	DDR0_DQS_N[15]	CMOS	I/O
P2	DDR0_DQS_P[15]	CMOS	I/O
P3	VSS	GND	
P4	DDR2_DQS_N[15]	CMOS	I/O
P5	DDR2_DQS_N[6]	CMOS	I/O
P6	DDR2_DQS_P[6]	CMOS	I/O
P7	DDR2_DQ[48]	CMOS	I/O
P8	VSS	GND	
P9	DDR2_DQ[50]	CMOS	I/O
P10	DDR2_DQ[51]	CMOS	I/O
P11	VSS	GND	
P33	VSS	GND	
P34	DDR1_DQ[8]	CMOS	I/O
P35	DDR1_DQ[9]	CMOS	I/O
P36	DDR1_DQS_P[10]	CMOS	I/O
P37	DDR1_DQS_N[10]	CMOS	I/O
P38	VSS	GND	
P39	DDR1_DQ[10]	CMOS	I/O
P40	DDR2_DQ[20]	CMOS	I/O
P41	DDR0_DQ[13]	CMOS	I/O
P42	DDR0_DQ[12]	CMOS	I/O
P43	VSS	GND	
R1	VSS	GND	

**Table 4-2. Land Listing by Land Number (Sheet 32 of 35)**

Land No.	Land Name	Buffer Type	Direction
R2	DDR0_DQS_P[6]	CMOS	I/O
R3	DDR0_DQS_N[6]	CMOS	I/O
R4	DDR0_DQ[54]	CMOS	I/O
R5	DDR1_DQ[50]	CMOS	I/O
R6	VSS	GND	
R7	DDR1_DQ[55]	CMOS	I/O
R8	DDR1_DQ[54]	CMOS	I/O
R9	DDR2_DQ[55]	CMOS	I/O
R10	DDR2_DQ[54]	CMOS	I/O
R11	VCC	PWR	
R33	VCC	PWR	
R34	DDR1_DQ[12]	CMOS	I/O
R35	DDR1_DQ[13]	CMOS	I/O
R36	VSS	GND	
R37	DDR1_DQS_N[1]	CMOS	I/O
R38	DDR1_DQS_P[1]	CMOS	I/O
R39	DDR2_DQ[10]	CMOS	I/O
R40	DDR2_DQ[15]	CMOS	I/O
R41	VSS	GND	
R42	DDR0_DQ[3]	CMOS	I/O
R43	DDR0_DQ[2]	CMOS	I/O
T1	DDR0_DQ[50]	CMOS	I/O
T2	DDR0_DQ[51]	CMOS	I/O
T3	DDR0_DQ[55]	CMOS	I/O
T4	VSS	GND	
T5	DDR1_DQ[51]	CMOS	I/O
T6	DDR2_DQ[60]	CMOS	I/O
T7	DDR2_DQ[61]	CMOS	I/O
T8	DDR2_DQS_N[7]	CMOS	I/O
T9	VSS	GND	
T10	DDR2_DQ[58]	CMOS	I/O
T11	VCC	PWR	
T33	VCC	PWR	
T34	VSS	GND	
T35	DDR2_DQS_N[9]	CMOS	I/O
T36	DDR2_DQ[11]	CMOS	I/O
T37	DDR2_DQS_P[1]	CMOS	I/O
T38	DDR2_DQS_N[1]	CMOS	I/O
T39	VSS	GND	
T40	DDR2_DQS_N[10]	CMOS	I/O



**Table 4-2. Land Listing by Land Number (Sheet 33 of 35)**

Land No.	Land Name	Buffer Type	Direction
T41	DDR2_DQ[14]	CMOS	I/O
T42	DDR0_DQ[7]	CMOS	I/O
T43	DDR0_DQS_P[0]	CMOS	I/O
U1	DDR0_DQ[60]	CMOS	I/O
U2	VSS	GND	
U3	DDR0_DQ[61]	CMOS	I/O
U4	DDR0_DQ[56]	CMOS	I/O
U5	DDR2_DQ[56]	CMOS	I/O
U6	DDR2_DQ[57]	CMOS	I/O
U7	VSS	GND	
U8	DDR2_DQS_P[7]	CMOS	I/O
U9	DDR2_DQ[63]	CMOS	I/O
U10	DDR2_DQ[59]	CMOS	I/O
U11	RSVD		
U33	VCCPLL	PWR	
U34	DDR2_DQ[4]	CMOS	I/O
U35	DDR2_DQS_P[9]	CMOS	I/O
U36	DDR2_DQ[3]	CMOS	I/O
U37	VSS	GND	
U38	DDR2_DQ[8]	CMOS	I/O
U39	DDR2_DQ[9]	CMOS	I/O
U40	DDR2_DQS_P[10]	CMOS	I/O
U41	DDR0_DQ[6]	CMOS	I/O
U42	VSS	GND	
U43	DDR0_DQS_N[0]	CMOS	I/O
V1	DDR0_DQ[57]	CMOS	I/O
V2	DDR0_DQS_P[16]	CMOS	I/O
V3	DDR0_DQS_N[16]	CMOS	I/O
V4	DDR0_DQ[62]	CMOS	I/O
V5	VSS	GND	
V6	DDR2_DQS_P[16]	CMOS	I/O
V7	DDR2_DQS_N[16]	CMOS	I/O
V8	DDR2_DQ[62]	CMOS	I/O
V9	DDR1_DQ[60]	CMOS	I/O
V10	VSS	GND	
V11	RSVD		
V33	VCCPLL	PWR	
V34	DDR2_DQ[5]	CMOS	I/O
V35	VSS	GND	
V36	DDR2_DQ[2]	CMOS	I/O

**Table 4-2. Land Listing by Land Number (Sheet 34 of 35)**

Land No.	Land Name	Buffer Type	Direction
V37	DDR2_DQ[6]	CMOS	I/O
V38	DDR2_DQ[7]	CMOS	I/O
V39	DDR2_DQ[13]	CMOS	I/O
V40	VSS	GND	
V41	DDR0_DQ[1]	CMOS	I/O
V42	DDR0_DQS_N[9]	CMOS	I/O
V43	DDR0_DQS_P[9]	CMOS	I/O
W1	DDR0_DQS_N[7]	CMOS	I/O
W2	DDR0_DQS_P[7]	CMOS	I/O
W3	VSS	GND	
W4	DDR0_DQ[63]	CMOS	I/O
W5	DDR1_DQ[61]	CMOS	I/O
W6	DDR1_DQ[56]	CMOS	I/O
W7	DDR1_DQ[57]	CMOS	I/O
W8	VSS	GND	
W9	DDR1_DQ[63]	CMOS	I/O
W10	DDR1_DQ[59]	CMOS	I/O
W11	VCC	PWR	
W33	VCCPLL	PWR	
W34	DDR2_DQ[0]	CMOS	I/O
W35	DDR2_DQ[1]	CMOS	I/O
W36	DDR2_DQS_N[0]	CMOS	I/O
W37	DDR2_DQS_P[0]	CMOS	I/O
W38	VSS	GND	
W39	DDR2_DQ[12]	CMOS	I/O
W40	DDR0_DQ[4]	CMOS	I/O
W41	DDR0_DQ[0]	CMOS	I/O
W42	DDR0_DQ[5]	CMOS	I/O
W43	VSS	GND	
Y1	VSS	GND	
Y2	DDR0_DQ[58]	CMOS	I/O
Y3	DDR0_DQ[59]	CMOS	I/O
Y4	DDR1_DQS_P[16]	CMOS	I/O
Y5	DDR1_DQS_N[16]	CMOS	I/O
Y6	VSS	GND	
Y7	DDR_COMP[1]	Analog	
Y8	DDR1_DQS_P[7]	CMOS	I/O
Y9	DDR1_DQS_N[7]	CMOS	I/O
Y10	DDR1_DQ[58]	CMOS	I/O
Y11	VSS	GND	



**Table 4-2. Land Listing by Land Number  
(Sheet 35 of 35)**

Land No.	Land Name	Buffer Type	Direction
Y33	VSS	GND	
Y34	DDR1_DQ[3]	CMOS	I/O
Y35	DDR1_DQ[2]	CMOS	I/O
Y36	VSS	GND	
Y37	DDR1_DQS_N[0]	CMOS	I/O
Y38	DDR1_DQS_P[0]	CMOS	I/O
Y39	DDR1_DQ[7]	CMOS	I/O
Y40	DDR1_DQ[6]	CMOS	I/O
Y41	VSS	GND	

§



# 5 Signal Definitions

## 5.1 Signal Definitions

Table 5-1. Signal Definitions (Sheet 1 of 4)

Name	Type	Description	Notes
BCLK_DN BCLK_DP	I	Differential bus clock input to the processor.	
BCLK_ITP_DN BCLK_ITP_DP	O	Buffered differential bus clock pair to ITP.	
BPM#[7:0]	I/O	BPM#[7:0] are breakpoint and performance monitor signals. They are outputs from the processor which indicate the status of breakpoints and programmable counters used for monitoring processor performance. BPM#[7:0] should be connected in a wired OR topology between all packages on a platform.	
CAT_ERR#	I/O	Indicates that the system has experienced a catastrophic error and cannot continue to operate. The processor will set this for non-recoverable machine check errors other internal unrecoverable error. It is expected that every processor in the system will have this hooked up in a wired-OR configuration. Since this is an I/O pin, external agents are allowed to assert this pin which will cause the processor to take a machine check exception. On Intel Xeon processor 5500 series, CAT_ERR# is used for signalling the following types of errors: <ul style="list-style-type: none"> <li>Legacy MCERR's, CAT_ERR# is pulsed for 16 BCLKs.</li> <li>Legacy IERR's, CAT_ERR remains asserted until warm or cold reset.</li> </ul>	
COMP0	I	Impedance Compensation must be terminated on the system board using precision resistor.	
QPI0_CLKRX_DN QPI0_CLKRX_DP	I I	Intel QuickPath Interconnect received clock is the input clock that corresponds to Intel QuickPath Interconnect port0 received data.	
QPI0_CLKTX_DN QPI0_CLKTX_DP	O O	Intel QuickPath Interconnect forwarded clock sent with Intel QuickPath Interconnect port 0 outbound data.	
QPI0_COMP	I	Must be terminated on the system board using precision resistor.	
QPI0_DRX_DN[19:0] QPI0_DRX_DP[19:0]	I I	QPI0_DRX_DN[19:0] and QPI0_DRX_DP[19:0] comprise the differential receive data for Intel QuickPath Interconnect port0. The inbound 20 lanes are connected to another component's outbound lanes.	
QPI0_DTX_DN[19:0] QPI0_DTX_DP[19:0]	O O	QPI0_DTX_DN[19:0] and QPI0_DTX_DP[19:0] comprise the differential transmit data for Intel QuickPath Interconnect port0. The outbound 20 lanes are connected to another component's inbound lanes.	
QPI1_CLKRX_DN QPI1_CLKRX_DP	I I	Intel QuickPath Interconnect received clock is the input clock that corresponds to Intel QuickPath Interconnect 1 port received data.	
QPI1_CLKTX_DN QPI1_CLKTX_DP	O O	Intel QuickPath Interconnect forwarded clock sent with Intel QuickPath Interconnect port1 outbound data.	
QPI1_COMP	I	Must be terminated on the system board using precision resistor.	
QPI1_DRX_DN[19:0] QPI1_DRX_DP[19:0]	I I	QPI1_DRX_DN[19:0] and QPI1_DRX_DP[19:0] comprise the differential receive data for Intel QuickPath Interconnect port1. The inbound 20 lanes are connected to another component's outbound lanes.	
QPI1_DTX_DN[19:0] QPI1_DTX_DP[19:0]	O O	QPI1_DTX_DN[19:0] and QPI1_DTX_DP[19:0] comprise the differential transmit data for Intel QuickPath Interconnect port1. The outbound 20 lanes are connected to another component's inbound lanes.	
DBR#	I	DBR# is used only in systems where no debug port is implemented on the system board. DBR# is used by a debug port interposer so that an in-target probe can drive system reset.	
DDR_COMP[2:0]	I	Must be terminated on the system board using precision resistors.	



Table 5-1. Signal Definitions (Sheet 2 of 4)

Name	Type	Description	Notes
DDR_THERM#	I	DDR_THERM# is used for imposing duty cycle throttling on all memory channels. The platform should ensure that DDR_THERM# is asserted when any DIMM is over T64 (85 °C)	
DDR{0/1/2}_BA[2:0]	O	Defines the bank which is the destination for the current Activate, Read, Write, or Precharge command.	1
DDR{0/1/2}_CAS#	O	Column Address Strobe.	
DDR{0/1/2}_CKE[3:0]	O	Clock Enable.	
DDR{0/1/2}_CLK_N[3:0] DDR{0/1/2}_CLK_P[3:0]	O	Differential clocks to the DIMM. All command and control signals are valid on the rising edge of clock.	
DDR{0/1/2}_CS[7:0]#	O	Each signal selects one rank as the target of the command and address.	
DDR{0/1/2}_DQ[63:0]	I/O	DDR3 Data bits.	
DDR{0/1/2}_DQS_N[17:0] DDR{0/1/2}_DQS_P[17:0]	I/O	Differential pair, Data/ECC Strobe. Differential strobes latch data/ECC for each DRAM. Different numbers of strobes are used depending on whether the connected DRAMs are x4,x8. Driven with edges in center of data, receive edges are aligned with data edges.	
DDR{0/1/2}_ECC[7:0]	I/O	Check Bits - An Error Correction Code is driven along with data on these lines for DIMMs that support that capability.	
DDR{0/1/2}_MA[15:0]	O	Selects the Row address for Reads and writes, and the column address for activates. Also used to set values for DRAM configuration registers.	
DDR{0/1/2}_MA_PAR	O	Odd parity across Address and Command.	
DDR{0/1/2}_ODT[3:0]	O	Enables various combinations of termination resistance in the target and non-target DIMMs when data is read or written	
DDR{0/1/2}_PAR_ERR#[2:0]	I	Parity Error detected by Registered DIMM (one for each DIMM).	
DDR{0/1/2}_RAS#	O	Row Address Strobe.	
DDR{0/1/2}_RESET#	O	Resets DRAMs. Held low on power up, held high during self refresh, otherwise controlled by configuration register.	
DDR_VREF	I	Voltage reference for DDR3.	
DDR{0/1/2}_WE#	O	Write Enable.	
GTLREF	I	Voltage reference for GTL signals.	
ISENSE	I	Current sense for VRD11.1.	
PECI	I/O	PECI (Platform Environment Control Interface) is the serial sideband interface to the processor and is used primarily for thermal, power and error management.	
PECI_ID#	I	PECI_ID# is the Peci client address identifier. Assertion of this pin results in a Peci client address of 0x31 (versus the default 0x30 client address). This pin is primarily useful for Peci client address differentiation in DP platforms. One of the two processors must be pulled down to VSS to strap to the address of 0x31.	
PRDY#	O	PRDY# is a processor output used by debug tools to determine processor debug readiness.	
PREQ#	I/O	PREQ# is used by debug tools to request debug operation of the processor.	
PROCHOT#	I/O	PROCHOT# will go active when the processor temperature monitoring sensor detects that the processor has reached its maximum safe operating temperature. This indicates that the processor Thermal Control Circuit has been activated, if enabled. This signal can also be driven to the processor to activate the Thermal Control Circuit.  If PROCHOT# is asserted at the deassertion of RESET#, the processor will tri-state its outputs. This signal does not have on-die termination and must be terminated on the system board.	



Table 5-1. Signal Definitions (Sheet 3 of 4)

Name	Type	Description	Notes
PSI#	O	Processor Power Status Indicator signal. This signal is asserted when maximum possible processor core current consumption is less than 20A, Assertion of this signal is an indication that the VR controller does not currently need to be able to provide ICC above 20A, and the VR controller can use this information to move to more efficient operation point. This signal will de-assert at least 3.3 $\mu$ s before the current consumption will exceed 20A. The minimum PSI# assertion time is 1 BCLK. The minimum PSI# de-assertion time is 3.3 $\mu$ s.  This pin does not require a pull-down. For platforms which could experience false PSI# assertions during power-up if this pin is left floating, a pull-up may be used (1K-5K). Otherwise, it can be left floating. For boards currently pulling this signal to Vss, this is not a critical change to make immediately, but it is recommended for production builds.	
RESET#	I	Asserting the RESET# signal resets the processor to a known state and invalidates its internal caches without writing back any of their contents. Note some PLL, Intel QuickPath Interconnect and error states are not effected by reset and only VCCPWRGOOD forces them to a known state. For a power-on Reset, RESET# must stay active for at least one millisecond after VCC and BCLK have reached their proper specifications. RESET# must not be kept asserted for more than 10 ms while VCCPWRGOOD is asserted. RESET# must be held deasserted for at least one millisecond before it is asserted again. RESET# must be held asserted before VCCPWRGOOD is asserted. This signal does not have on-die termination and must be terminated on the system board. RESET# is a common clock signal.	
SKTOCC#	O	Socket occupied, platform must sense a VSS at this pin to enable POWER_ON.	
TCK	I	TCK (Test Clock) provides the clock input for the processor Test Bus (also known as the Test Access Port).	
TDI	I	TDI (Test Data In) transfers serial test data into the processor. TDI provides the serial input needed for JTAG specification support.	
TDO	O	TDO (Test Data Out) transfers serial test data out of the processor. TDO provides the serial output needed for JTAG specification support.	
THERMTRIP#	O	Assertion of THERMTRIP# (Thermal Trip) indicates the processor junction temperature has reached a level beyond which permanent silicon damage may occur. Measurement of the temperature is accomplished through an internal thermal sensor. Once activated, the processor will stop all execution and shut down all PLLs. To further protect the processor, its core voltage ( $V_{CC}$ ), $V_{TTA}$ , $V_{TTD}$ and $V_{DDQ}$ must be removed following the assertion of THERMTRIP#. Once activated, THERMTRIP# remains latched until RESET# is asserted. While the assertion of the RESET# signal may de-assert THERMTRIP#, if the processor's junction temperature remains at or above the trip level, THERMTRIP# will again be asserted after RESET# is de-asserted.	
TMS	I	TMS (Test Mode Select) is a JTAG specification support signal used by debug tools.	
TRST#	I	TRST# (Test Reset) resets the Test Access Port (TAP) logic. TRST# must be driven low during power on Reset.	
$V_{CC\_SENSE}$ $V_{SS\_SENSE}$	O O	$V_{CC\_SENSE}$ and $V_{SS\_SENSE}$ provide an isolated, low impedance connection to the processor core voltage and ground. They can be used to sense or measure power near the silicon with little noise.	
$V_{CC}$	I	Power for processor core.	
VCCPWRGOOD	I	VCCPWRGOOD (Power Good) is a processor input. The processor requires this signal to be a clean indication that BCLK, $V_{CC}$ , $V_{CCPLL}$ , $V_{TTA}$ and $V_{TTD}$ supplies are stable and within their specifications. 'Clean' implies that the signal will remain low (capable of sinking leakage current), without glitches, from the time that the power supplies are turned on until they come within specification. The signal must then transition monotonically to a high state. VCCPWRGOOD can be driven inactive at any time, but BCLK and power must again be stable before a subsequent rising edge of VCCPWRGOOD. In addition at the time VCCPWRGOOD is asserted RESET# must be active. The PWRGOOD signal must be supplied to the processor; it is used to protect internal circuits against voltage sequencing issues. It should be driven high throughout boundary scan operation.	
$V_{CCPLL}$	I	Analog Power for Clocks.	
$V_{DDQ}$	I	Power supply for the DDR3 interface.	



Table 5-1. Signal Definitions (Sheet 4 of 4)

Name	Type	Description	Notes
VTT_VID[4:2]	O	VTT_VID[4:2] is used to support automatic selection of power supply voltages ( $V_{TT}$ ). The voltage supply for this signal must be valid before the VR can supply $V_{TT}$ to the processor. Conversely, the VR output must be disabled until the voltage supply for the VID signal become valid. The VID signal is needed to support the processor voltage specification variations. The VR must supply the voltage that is requested by the signal.	
$V_{TTA}$	I	Power for the analog portion of the Intel QuickPath Interconnect and Shared Cache.	
$V_{TTD}$	I	Power for the digital portion of the Intel QuickPath Interconnect and Shared Cache.	
VDDPWRGOOD	I	VDDPWRGOOD is an input that indicates the Vddq power supply is good. The processor requires this signal to be a clean indication that the Vddq power supply is stable and within their specifications. "Clean" implies that the signal will remain low (capable of sinking leakage current), without glitches, from the time that the Vddq supply is turned on until it come within specification. The signals must then transition monotonically to a high state. The PwrGood signal must be supplied to the processor, This signal is used to protect internal circuits against voltage sequencing issues.	
VID[7:6] VID[5:3]/CSC[2:0] VID[2:0]/MSID[2:0]	I/O	VID[7:0] (Voltage ID) are output signals that are used to support automatic selection of power supply voltages ( $V_{CC}$ ). The voltage supply for these signals must be valid before the VR can supply $V_{CC}$ to the processor. Conversely, the VR output must be disabled until the voltage supply for the VID signals become valid. The VID signals are needed to support the processor voltage specification variations. The VR must supply the voltage that is requested by the signals, or disable itself. VID7 and VID6 should be tied separately to $V_{SS}$ via 1KOhm resistors during reset (this value is latched on the rising edge of VTTTPWRGOOD). MSID[2:0] - Market Segment ID, or MSID are provided to indicate the Market Segment for the processor and may be used for future processor compatibility or for keying. In addition, MSID protects the platform by preventing a higher power processor from booting in a platform designed for lower power processors. This value is latched from the platform in to the CPU, on the rising edge of VTTTPWRGOOD, during the cold boot power up sequence. CSC[2:0] - Current Sense Configuration bits are output signals for ISENSE gain setting. This value is latched on the rising edge of VTTTPWRGOOD.	2
$V_{TTD\_SENSE}$ $V_{SS\_SENSE\_VTT}$	O O	$V_{TTD\_SENSE}$ and $V_{SS\_SENSE\_VTT}$ provide an isolated, low impedance connection to the processor power and ground. They can used to sense or measure power near the silicon.	
VTTTPWRGOOD	I	The processor requires this input signal to be a clean indication that the VTT power supply is stable and within their specifications. 'Clean' implies that the signal will remain low (capable of sinking leakage current), without glitches, from the time that the power supplies are turned on until they come within specification. The signal must then transition monotonically to a high state. to determine that the VTT voltage is stable and within specification. Note it is not valid for VTTTPWRGOOD to be deasserted while VCCPWRGOOD is asserted.	
$V_{SS}$		The processor ground.	

**Notes:**

1. DDR{0/1/2} refers to DDR3 Channel 0, DDR3 Channel 1, and DDR3 Channel 2.
2. VID[7:0] is an Input only during Power On Configuration. It is an Output signal during normal operation.

**§**





# 6 Thermal Specifications

## 6.1 Package Thermal Specifications

The Intel® Xeon® processor 5500 series requires a thermal solution to maintain temperatures within operating limits. Any attempt to operate the processor outside these limits may result in permanent damage to the processor and potentially other components within the system. Maintaining the proper thermal environment is key to reliable, long-term system operation.

A complete solution includes both component and system level thermal management features. Component level thermal solutions can include active or passive heatsinks attached to the processor integrated heat spreader (IHS). Typical system level thermal solutions may consist of system fans combined with ducting and venting.

This section provides data necessary for developing a complete thermal solution. For more information on designing a component level thermal solution, refer to the *Intel® Xeon® Processor 5500/5600 Series Thermal/Mechanical Design Guide*.

**Note:** The boxed processor will ship with a component thermal solution. Refer to [Section 8](#) for details on the boxed processor.

### 6.1.1 Thermal Specifications

To allow optimal operation and long-term reliability of Intel processor-based systems, the processor must remain within the minimum and maximum case temperature ( $T_{CASE}$ ) specifications as defined by the applicable thermal profile. See [Table 6-2](#) and [Figure 6-1](#) for Intel® Xeon® Processor W5580 (130W TDP); [Table 6-4](#) and [Table 6-5](#), and [Figure 6-2](#) for Intel Xeon processor 5500 series Advanced SKU (95W TDP); [Table 6-7](#) and [Figure 6-3](#) for Intel Xeon processor 5500 series Standard/Basic SKUs (80W TDP); [Table 6-9](#) and [Figure 6-4](#) for Intel Xeon processor 5500 series Low Power SKU (60W TDP); [Table 6-11](#) and [Figure 6-5](#) for Intel® Xeon® Processor L5518 (60W TDP) supporting NEBS thermals; [Table 6-13](#) and [Figure 6-6](#) for Intel® Xeon® Processor L5508 (38W TDP) supporting NEBS thermals. Thermal solutions not designed to provide this level of thermal capability may affect the long-term reliability of the processor and system. For more details on thermal solution design, please refer to this processor's TMDG.

The Intel Xeon processor 5500 series implement a methodology for managing processor temperatures which is intended to support acoustic noise reduction through fan speed control and to assure processor reliability. Selection of the appropriate fan speed is based on the relative temperature data reported by the processor's Platform Environment Control Interface (PECI) as described in [Section 6.3](#). If PEGI is less than TCONTROL, then the case temperature is permitted to exceed the Thermal Profile, but PEGI must remain at or below TCONTROL. If PEGI  $\geq$  TCONTROL, then the case temperature must meet the Thermal Profile. The temperature reported over PEGI is always a negative value and represents a delta below the onset of thermal control circuit (TCC) activation, as indicated by PROCHOT# (see [Section 6.2](#), Processor Thermal Features). Systems that implement fan speed control must be designed to use this data. Systems that do not alter the fan speed only need to guarantee the case temperature meets the thermal profile specifications.



The Intel Xeon Processor W5580 (see [Figure 6-1](#); [Table 6-2](#)) supports a single Thermal Profile. For this processor, it is expected that the Thermal Control Circuit (TCC) would only be activated for very brief periods of time when running the most power-intensive applications. Refer to the *Intel® Xeon® Processor 5500/5600 Series Thermal / Mechanical Design Guide* for details on system thermal solution design, thermal profiles and environmental considerations.

The Intel Xeon processor 5500 series Advanced SKU supports two thermal profiles, either of which can be implemented. Both ensure adherence to Intel reliability requirements. Thermal Profile A (see [Figure 6-2](#); [Table 6-4](#)) is representative of a volumetrically unconstrained thermal solution (that is, industry enabled 2U heatsink). In this scenario, it is expected that the Thermal Control Circuit (TCC) would only be activated for very brief periods of time when running the most power intensive applications. Thermal Profile B (see [Figure 6-2](#); [Table 6-5](#)) is indicative of a constrained thermal environment (that is, 1U form factor). Because of the reduced cooling capability represented by this thermal solution, the probability of TCC activation and performance loss is increased. Additionally, utilization of a thermal solution that does not meet Thermal Profile B will violate the thermal specifications and may result in permanent damage to the processor. Refer to this processor's TMDG for details on system thermal solution design, thermal profiles and environmental considerations.

The upper point of the thermal profile consists of the Thermal Design Power (TDP) and the associated  $T_{CASE}$  value. It should be noted that the upper point associated with the Intel Xeon processor 5500 series Advanced SKU Thermal Profile B ( $x = TDP$  and  $y = T_{CASE\_MAX\_B @ TDP}$ ) represents a thermal solution design point. In actuality the processor case temperature will not reach this value due to TCC activation (see [Figure 6-2](#) for Intel Xeon processor 5500 series Advanced SKU).

The Intel Xeon processor 5500 series Standard/Basic SKUs (see [Figure 6-3](#); [Table 6-7](#)) support a single Thermal Profile. For this processor, it is expected that the Thermal Control Circuit (TCC) would only be activated for very brief periods of time when running the most power-intensive applications. Refer to this processor's TMDG for details on system thermal solution design, thermal profiles and environmental considerations.

The Intel Xeon processor 5500 series Low Power SKU (see [Figure 6-4](#); [Table 6-9](#)) supports a single Thermal Profile. For this processor, it is expected that the Thermal Control Circuit (TCC) would only be activated for very brief periods of time when running the most power-intensive applications. Refer to this processor's TMDG for details on system thermal solution design, thermal profiles and environmental considerations.

The Intel Xeon Processor L5518 and Intel Xeon Processor L5508 both support Thermal Profiles with nominal and short-term conditions designed to meet NEBS level 3 compliance (see [Figure 6-5](#) and [Figure 6-6](#) respectively). For these SKU's operation at either the nominal or short-term thermal profiles should result in virtually no TCC activation.

Analysis indicates that real applications are unlikely to cause the processor to consume maximum power dissipation for sustained time periods. Intel recommends that complete thermal solution designs target the Thermal Design Power (TDP), instead of the maximum processor power consumption. The Adaptive Thermal Monitor feature is intended to help protect the processor in the event that an application exceeds the TDP recommendation for a sustained time period. For more details on this feature, refer to [Section 6.2](#). To ensure maximum flexibility for future requirements, systems should be



designed to the Flexible Motherboard (FMB) guidelines, even if a processor with lower power dissipation is currently planned. **The Adaptive Thermal Monitor feature must be enabled for the processor to remain within its specifications.**

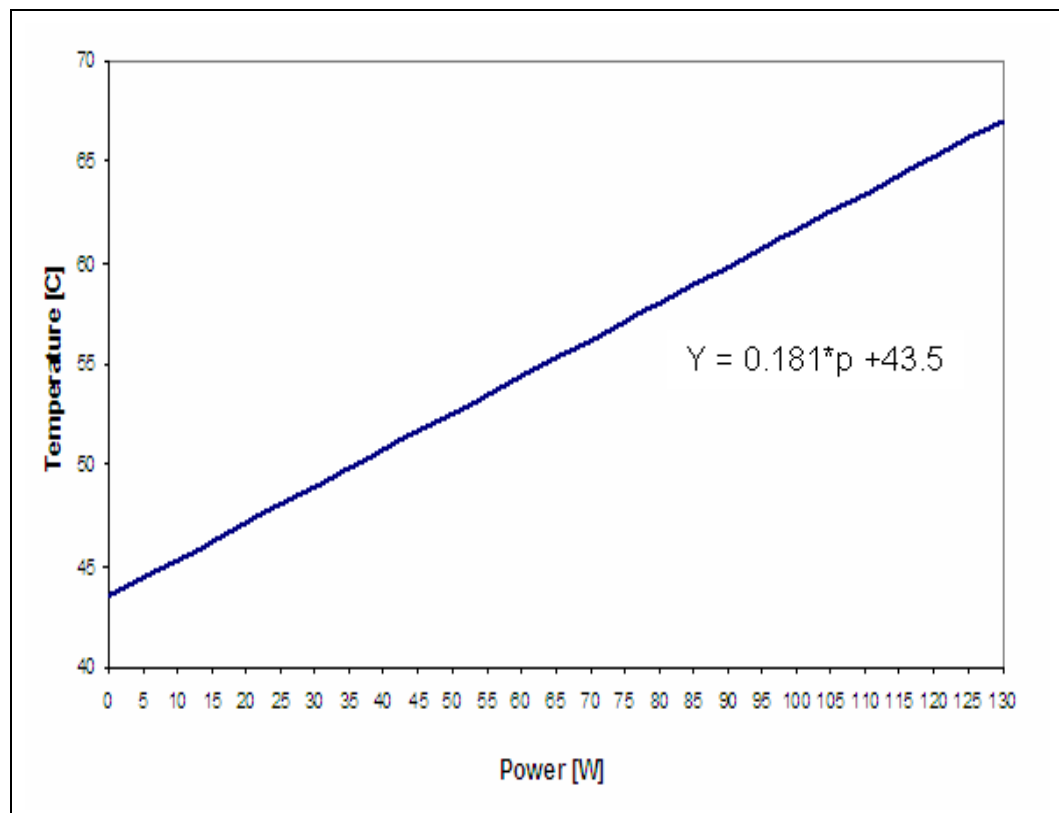
**Table 6-1. Intel® Xeon® Processor W5580 Thermal Specifications**

Core Frequency	Thermal Design Power (W)	Minimum TCASE (°C)	Maximum TCASE (°C)	Notes
Launch to FMB	130	5	See Figure 6-2; Table 6-4	1, 2, 3, 4, 5

**Notes:**

1. These values are specified at  $V_{CC\_MAX}$  for all processor frequencies. Systems must be designed to ensure the processor is not to be subjected to any static  $V_{CC}$  and  $I_{CC}$  combination wherein  $V_{CC}$  exceeds  $V_{CC\_MAX}$  at specified ICC. Please refer to the loadline specifications in Section 2.6.
2. Thermal Design Power (TDP) should be used for processor thermal solution design targets. TDP is not the maximum power that the processor can dissipate. TDP is measured at maximum  $T_{CASE}$ .
3. These specifications are based on initial silicon characterization. These specifications may be further updated as more characterization data becomes available.
4. Power specifications are defined at all VIDs found in Table 2-2. The Intel Xeon processor 5500 series may be shipped under multiple VIDs for each frequency.
5. FMB, or Flexible Motherboard, guidelines provide a design target for meeting all planned processor frequency requirements.

**Figure 6-1. Intel® Xeon® Processor W5580 Thermal Profile**



**Notes:**

1. Intel Xeon Processor W5580 Thermal Profile is representative of a volumetrically unconstrained platform. Please refer to Table 6-2 for discrete points that constitute the thermal profile.
2. Implementation of Intel Xeon Processor W5580 Thermal Profile should result in virtually no TCC activation.
3. Refer to the Intel® Xeon® Processor 5500/5600 Series Thermal / Mechanical Design Guide for system and environmental implementation details.



**Table 6-2. Intel Xeon Processor W5580 Thermal Profile**

Power (W)	T <sub>CASE_MAX</sub> (°C)
0	43.5
5	44.4
10	45.3
15	46.2
20	47.1
25	48.0
30	48.9
35.6	49.9
40	50.7
45	51.6
50	52.6
55	53.5
60	54.4
65	55.3
70	56.2
75	57.1
80	58.0
85	58.9
90	59.8
95	60.7
100	61.6
105	62.5
110	63.4
115	64.3
120	65.2
125	66.1
130	67.0

**Table 6-3. Intel Xeon Processor 5500 Series Advanced SKU Thermal Specifications**

Core Frequency	Thermal Design Power (W)	Minimum TCASE (°C)	Maximum TCASE (°C)	Notes
Launch to FMB	95	5	See Figure 6-2; Table 6-4	1, 2, 3, 4, 5

**Notes:**

1. These values are specified at V<sub>CC\_MAX</sub> for all processor frequencies. Systems must be designed to ensure the processor is not to be subjected to any static V<sub>CC</sub> and I<sub>CC</sub> combination wherein V<sub>CC</sub> exceeds V<sub>CC\_MAX</sub> at specified ICC. Please refer to the loadline specifications in Section 2.6.
2. Thermal Design Power (TDP) should be used for processor thermal solution design targets. TDP is not the maximum power that the processor can dissipate. TDP is measured at maximum T<sub>CASE</sub>.
3. These specifications are based on initial silicon characterization. These specifications may be further updated as more characterization data becomes available.
4. Power specifications are defined at all VIDs found in Table 2-2. The Intel Xeon processor 5500 series may be shipped under multiple VIDs for each frequency.
5. FMB or Flexible Motherboard guidelines provide a design target for meeting all planned processor frequency requirements.

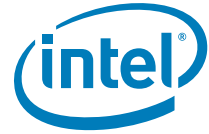
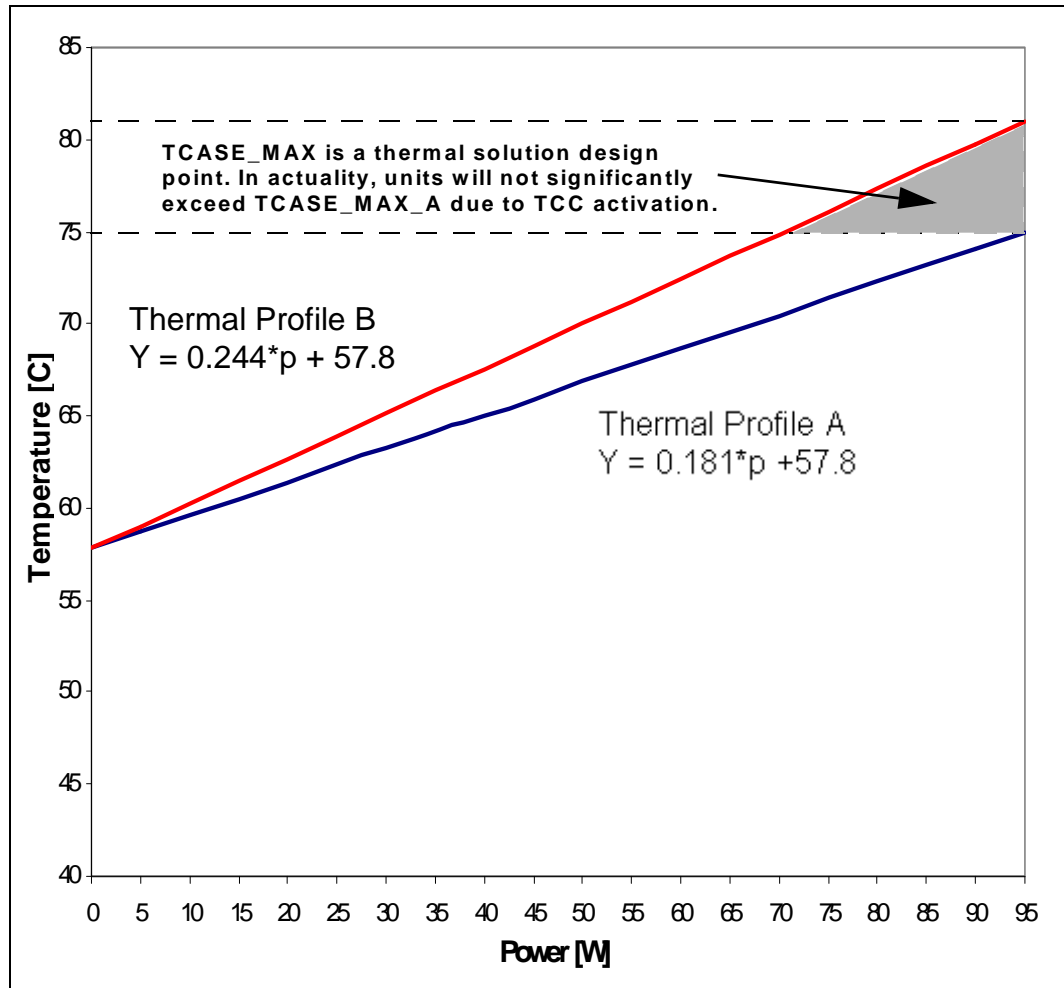


Figure 6-2. Intel® Xeon® Processor 5500 Series Advanced SKU Thermal Profile



Notes:

1. Intel Xeon processor 5500 series Advanced SKU Thermal Profile A is representative of a volumetrically unconstrained platform. Please refer to Table 6-4 for discrete points that constitute thermal profile A.
2. Implementation of Intel Xeon processor 5500 series Advanced SKU Thermal Profile A should result in virtually no TCC activation. Furthermore, utilization of thermal solutions that do not meet Profile A will result in increased probability of TCC activation and may incur measurable performance loss.
3. Intel Xeon processor 5500 series Advanced SKU Thermal Profile B is representative of a volumetrically constrained platform. Please refer to Table 6-5 for discrete points that constitute thermal profile B.
4. Refer to the *Intel® Xeon® Processor 5500/5600 Series Thermal / Mechanical Design Guide* for system and environmental implementation details.



**Table 6-4. Intel Xeon Processor 5500 Series Advanced SKU Thermal Profile A**

Power (W)	T <sub>CASE_MAX</sub> (°C)
0	57.8
5	58.7
10	59.6
15	60.5
20	61.4
25	62.3
30	63.2
35.6	64.2
40	65.0
45	65.9
50	66.9
55	67.8
60	68.7
65	69.6
70	70.5
75	71.4
80	72.3
85	73.2
90	74.1
95	75.0

**Table 6-5. Intel Xeon Processor 5500 Series Advanced SKU Thermal Profile B**

Power (W)	T <sub>CASE_MAX</sub> (°C)
0	57.8
5	59.0
10	60.2
15	61.5
20	62.7
25	63.9
30	65.1
35	66.3
40	67.6
45	68.8
50	70.0
55	71.2
60	72.4
65	73.7
70	74.9
75	76.1
80	77.3
85	78.5
90	79.8
95	81.0



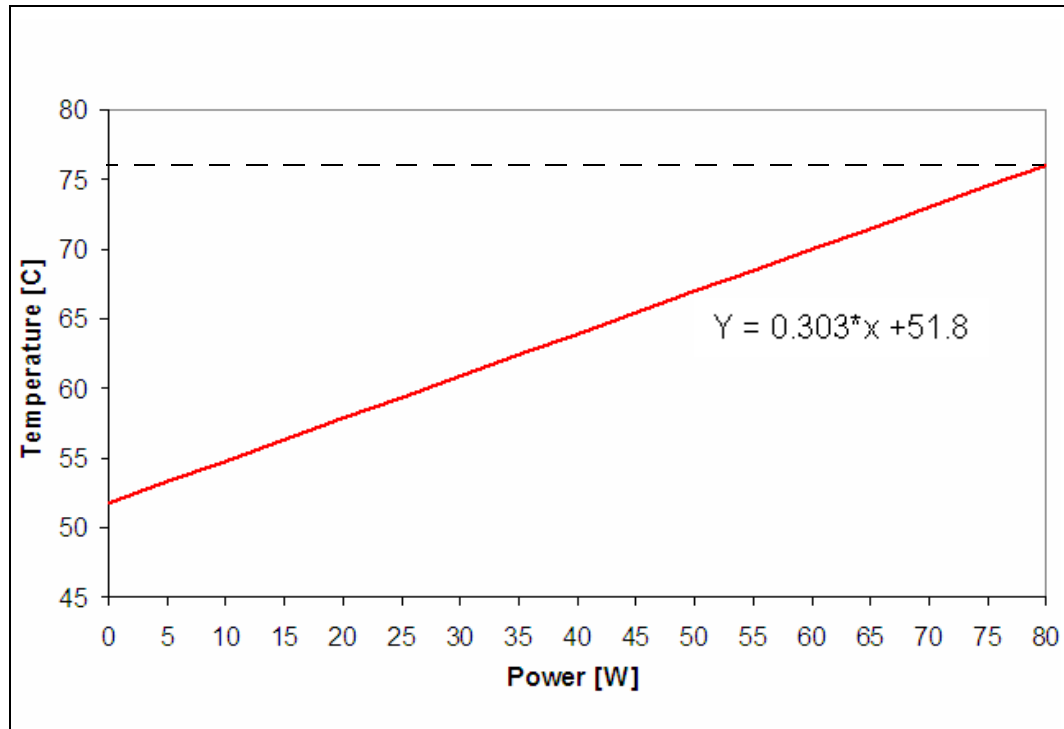
**Table 6-6. Intel Xeon Processor 5500 Series Standard/Basic SKUs Thermal Specifications**

Core Frequency	Thermal Design Power (W)	Minimum TCASE (°C)	Maximum TCASE (°C)	Notes
Launch to FMB	80	5	See Figure 6-3; Table 6-7;	1, 2, 3, 4, 5

**Notes:**

1. These values are specified at  $V_{CC\_MAX}$  for all processor frequencies. Systems must be designed to ensure the processor is not to be subjected to any static  $V_{CC}$  and  $I_{CC}$  combination wherein  $V_{CC}$  exceeds  $V_{CC\_MAX}$  at specified  $I_{CC}$ . Please refer to the loadline specifications in [Section 2.6](#).
2. Thermal Design Power (TDP) should be used for processor thermal solution design targets. TDP is not the maximum power that the processor can dissipate. TDP is measured at maximum  $T_{CASE}$ .
3. These specifications are based on initial silicon characterization. These specifications may be further updated as more characterization data becomes available.
4. Power specifications are defined at all VIDs found in [Table 2-2](#). The Intel Xeon processor 5500 series may be shipped under multiple VIDs for each frequency.
5. FMB, or Flexible Motherboard, guidelines provide a design target for meeting all planned processor frequency requirements.

**Figure 6-3. Intel Xeon Processor 5500 Series Standard/Basic SKUs Thermal Profile**



**Notes:**

1. Intel Xeon processor 5500 series Standard/Basic SKUs processor Thermal Profile is representative of a volumetrically constrained platform. Please refer to [Table 6-7](#) for discrete points that constitute the thermal profile.
2. Implementation of Intel Xeon processor 5500 series Standard/Basic SKUs Thermal Profile should result in virtually no TCC activation.
3. Refer to the *Intel® Xeon® Processor 5500/5600 Series Thermal / Mechanical Design Guide* for system and environmental implementation details.



**Table 6-7. Intel Xeon Processor 5500 Series Standard/Basic SKUs Thermal Profile**

Power (W)	T <sub>CASE_MAX</sub> (°C)
0	51.8
5	53.3
10	54.8
15	56.3
20	57.9
25	59.4
30	60.9
35	62.4
40	63.9
45	65.4
50	67.0
55	68.5
60	70.0
65	71.5
70	73.0
75	74.5
80	76.0

**Table 6-8. Intel Xeon Processor 5500 Series Low Power SKU Thermal Specifications**

Core Frequency	Thermal Design Power (W)	Minimum TCASE (°C)	Maximum TCASE (°C)	Notes
Launch to FMB	60	5	See Figure 6-4; Table 6-9	1, 2, 3, 4, 5

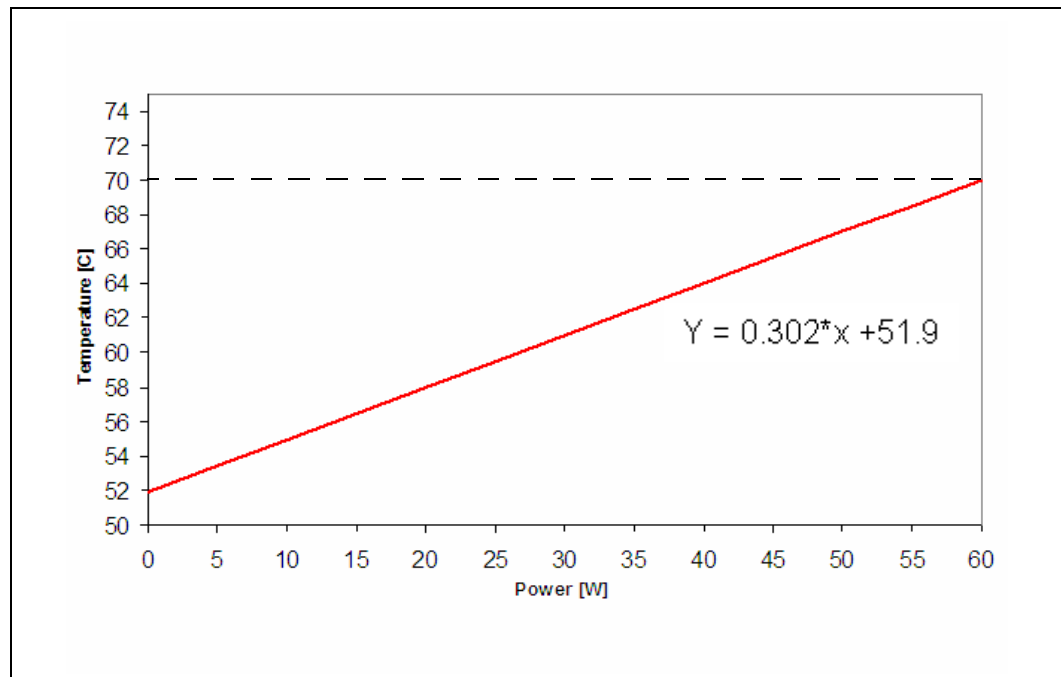
**Notes:**

1. These values are specified at V<sub>CC\_MAX</sub> for all processor frequencies. Systems must be designed to ensure the processor is not to be subjected to any static V<sub>CC</sub> and I<sub>CC</sub> combination wherein V<sub>CC</sub> exceeds V<sub>CC\_MAX</sub> at specified I<sub>CC</sub>. Please refer to the loadline specifications in Section 2.6.
2. Thermal Design Power (TDP) should be used for processor thermal solution design targets. TDP is not the maximum power that the processor can dissipate. TDP is measured at maximum T<sub>CASE</sub>.
3. These specifications are based on initial silicon characterization. These specifications may be further updated as more characterization data becomes available.
4. Power specifications are defined at all VIDs found in Table 2-2. The Intel Xeon processor 5500 series Low Power SKU may be shipped under multiple VIDs for each frequency.
5. FMB, or Flexible Motherboard, guidelines provide a design target for meeting all planned processor frequency requirements.





Figure 6-4. Intel Xeon Processor 5500 Series Low Power SKU Thermal Profile



**Notes:**

1. Intel Xeon processor 5500 series Low Power SKU Thermal Profile is representative of a volumetrically constrained platform. Please refer to [Table 6-9](#) for discrete points that constitute the thermal profile.
2. Implementation of Intel Xeon processor 5500 series Low Power SKU Thermal Profile should result in virtually no TCC activation. Furthermore, utilization of thermal solutions that do not meet Intel Xeon processor 5500 series Low Power SKU Thermal Profile will result in increased probability of TCC activation and may incur measurable performance loss.
3. Refer to the *Intel® Xeon® Processor 5500 Series Thermal / Mechanical Design Guide* for system and environmental implementation details.



Table 6-9. Intel Xeon Processor 5500 Series Low Power SKU Thermal Profile

Power (W)	T <sub>CASE_MAX</sub> (°C)
0	51.9
5	53.4
10	54.9
15	56.4
20	57.9
25	59.5
30	61.0
35	62.5
40	64.0
45	65.5
50	67.0
55	68.5
60	70.0

**Notes:**

1. These values are specified at V<sub>CC\_MAX</sub> for all processor frequencies. Systems must be designed to ensure the processor is not to be subjected to any static V<sub>CC</sub> and I<sub>CC</sub> combination wherein V<sub>CC</sub> exceeds V<sub>CC\_MAX</sub> at specified I<sub>CC</sub>. Please refer to the loadline specifications in [Section 2.6](#).
2. Thermal Design Power (TDP) should be used for processor thermal solution design targets. TDP is not the maximum power that the processor can dissipate. TDP is measured at maximum T<sub>CASE</sub>.
3. These specifications are based on initial silicon characterization. These specifications may be further updated as more characterization data becomes available.
4. Power specifications are defined at all VIDs found in [Table 2-2](#). The Intel Xeon processor 5500 series may be shipped under multiple VIDs for each frequency.
5. FMB, or Flexible Motherboard, guidelines provide a design target for meeting all planned processor frequency requirements.

Table 6-10. Intel Xeon Processor L5518 Thermal Specifications

Core Frequency	Thermal Design Power (W)	Minimum TCASE (°C)	Maximum TCASE (°C)	Notes
Launch to FMB	60	5	See <a href="#">Figure 6-5</a> ; <a href="#">Table 6-11</a>	1, 2, 3, 4, 5

**Notes:**

1. These values are specified at V<sub>CC\_MAX</sub> for all processor frequencies. Systems must be designed to ensure the processor is not to be subjected to any static V<sub>CC</sub> and I<sub>CC</sub> combination wherein V<sub>CC</sub> exceeds V<sub>CC\_MAX</sub> at specified I<sub>CC</sub>. Please refer to the loadline specifications in [Section 2.6](#).
2. Thermal Design Power (TDP) should be used for processor thermal solution design targets. TDP is not the maximum power that the processor can dissipate. TDP is measured at maximum T<sub>CASE</sub>.
3. These specifications are based on initial silicon characterization. These specifications may be further updated as more characterization data becomes available.
4. Power specifications are defined at all VIDs found in [Table 2-2](#). The Intel Xeon Processor L5518 may be shipped under multiple VIDs for each frequency.
5. FMB, or Flexible Motherboard, guidelines provide a design target for meeting all planned processor frequency requirements.

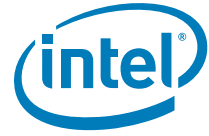
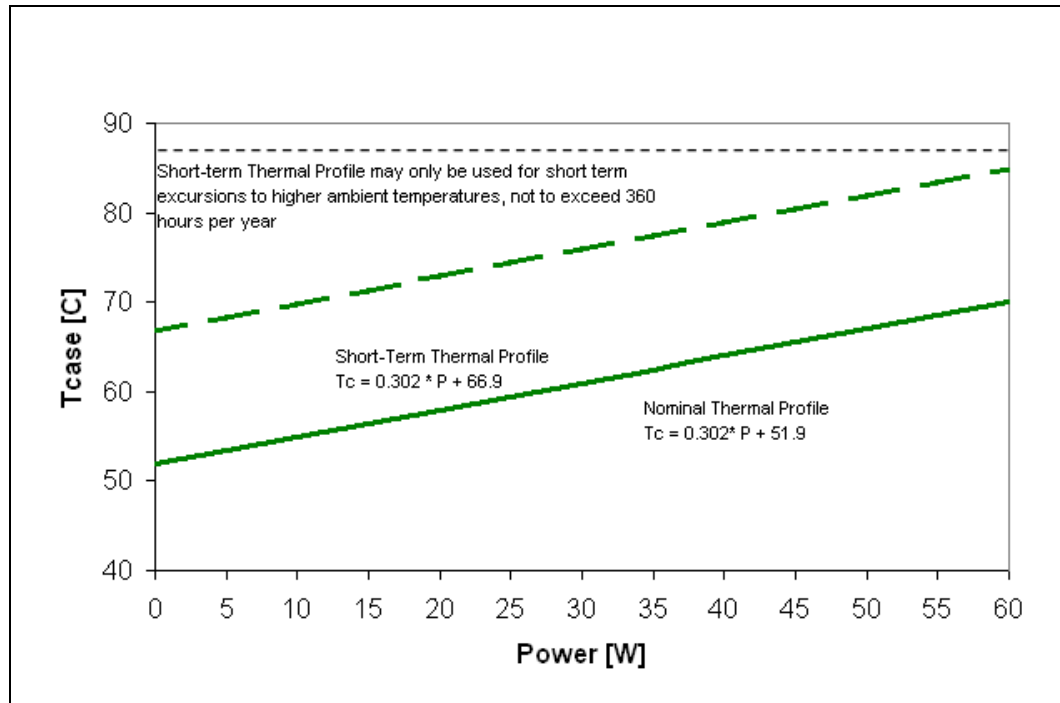


Figure 6-5. Intel Xeon Processor L5518 Thermal Profile



**Notes:**

1. Intel Xeon Processor L5518 Thermal Profile is representative of a volumetrically constrained platform. Please refer to [Table 6-11](#) for discrete points that constitute the thermal profile.
2. Implementation of Intel Xeon Processor L5518 nominal and short-term thermal profiles should result in virtually no TCC activation. Furthermore, utilization of thermal solutions that do not meet this Thermal Profile will result in increased probability of TCC activation and may incur measurable performance loss.
3. The Nominal Thermal Profile must be used for all normal operating conditions, or for products that do not require NEBS Level 3 compliance.
4. The Short-Term Thermal Profile may only be used for short-term excursions to higher ambient operating temperatures, not to exceed 96 hours per instance, 360 hours per year, and a maximum of 15 instances per year, as compliant with NEBS Level 3. Operation at the Short-Term Thermal Profile for durations exceeding 360 hours per year violate the processor thermal specifications and may result in permanent damage to the processor.
5. Refer to the *Intel® Xeon® Processor 5500/5600 Series Thermal / Mechanical Design Guide* for system and environmental implementation details.



**Table 6-11. Intel Xeon Processor L5518 Thermal Profile**

Power (W)	Nominal T <sub>CASE_MAX</sub> (°C)	Short-term T <sub>CASE_MAX</sub> (°C)
0	51.9	66.9
5	53.4	68.4
10	54.9	69.9
15	56.4	71.4
20	57.9	72.9
25	59.5	74.5
30	61.0	76.0
35	62.5	77.5
40	64.0	79.0
45	65.5	80.5
50	67.0	82.0
55	68.5	83.5
60	70.0	85.0

**Notes:**

1. These values are specified at V<sub>CC\_MAX</sub> for all processor frequencies. Systems must be designed to ensure the processor is not to be subjected to any static V<sub>CC</sub> and I<sub>CC</sub> combination wherein V<sub>CC</sub> exceeds V<sub>CC\_MAX</sub> at specified I<sub>CC</sub>. Please refer to the loadline specifications in [Section 2.6](#).
2. Thermal Design Power (TDP) should be used for processor thermal solution design targets. TDP is not the maximum power that the processor can dissipate. TDP is measured at maximum T<sub>CASE</sub>.
3. These specifications are based on initial silicon characterization. These specifications may be further updated as more characterization data becomes available.
4. Power specifications are defined at all VIDs found in [Table 2-2](#). The Intel Xeon Processor L5518 may be shipped under multiple VIDs for each frequency.
5. FMB, or Flexible Motherboard, guidelines provide a design target for meeting all planned processor frequency requirements.

**Table 6-12. Intel Xeon Processor L5508 Thermal Specifications**

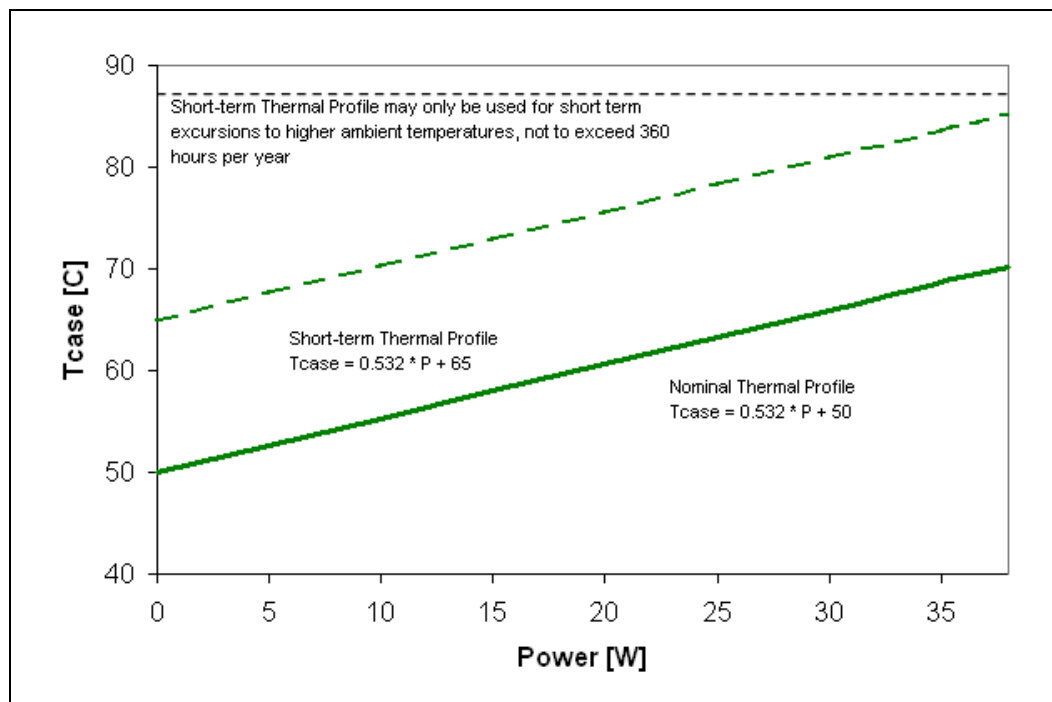
Core Frequency	Thermal Design Power (W)	Minimum TCASE (°C)	Maximum TCASE (°C)	Notes
Launch to FMB	38	5	See <a href="#">Figure 6-6</a> ; <a href="#">Table 6-13</a>	1, 2, 3, 4, 5, 6

**Notes:**

1. These values are specified at V<sub>CC\_MAX</sub> for all processor frequencies. Systems must be designed to ensure the processor is not to be subjected to any static V<sub>CC</sub> and I<sub>CC</sub> combination wherein V<sub>CC</sub> exceeds V<sub>CC\_MAX</sub> at specified I<sub>CC</sub>. Please refer to the loadline specifications in [Section 2.6](#).
2. Thermal Design Power (TDP) should be used for processor thermal solution design targets. TDP is not the maximum power that the processor can dissipate. TDP is measured at maximum T<sub>CASE</sub>.
3. These specifications are based on initial silicon characterization. These specifications may be further updated as more characterization data becomes available.
4. Power specifications are defined at all VIDs found in [Table 2-2](#). The Intel Xeon Processor L5508 may be shipped under multiple VIDs for each frequency.
5. FMB, or Flexible Motherboard, guidelines provide a design target for meeting all planned processor frequency requirements.



Figure 6-6. Intel Xeon Processor L5508 Thermal Profile



**Notes:**

1. Intel Xeon Processor L5508 Thermal Profile is representative of a volumetrically constrained platform. Please refer to Table 6-13 for discrete points that constitute the thermal profile.
2. Implementation of Intel Xeon Processor L5508 nominal and short-term thermal profiles should result in virtually no TCC activation. Furthermore, utilization of thermal solutions that do not meet this Thermal Profile will result in increased probability of TCC activation and may incur measurable performance loss.
3. The Nominal Thermal Profile must be used for all normal operating conditions, or for products that do not require NEBS Level 3 compliance.
4. The Short-Term Thermal Profile may only be used for short-term excursions to higher ambient operating temperatures, not to exceed 96 hours per instance, 360 hours per year, and a maximum of 15 instances per year, as compliant with NEBS Level 3. Operation at the Short-Term Thermal Profile for durations exceeding 360 hours per year violate the processor thermal specifications and may result in permanent damage to the processor.
5. Refer to the *Intel® Xeon® Processor 5500 Series Thermal / Mechanical Design Guide* for system and environmental implementation details.

Table 6-13. Intel Xeon Processor L5508 Thermal Profile

Power (W)	Nominal T <sub>CASE_MAX</sub> (°C)	Short-Term T <sub>CASE_MAX</sub> (°C)
0	50.0	65.0
5	52.7	67.7
10	55.3	70.3
15	58.0	73.0
20	60.6	75.6
25	63.3	78.3
30	66.0	81.0
35	68.6	83.6
38	70.2	85.2

**Notes:**

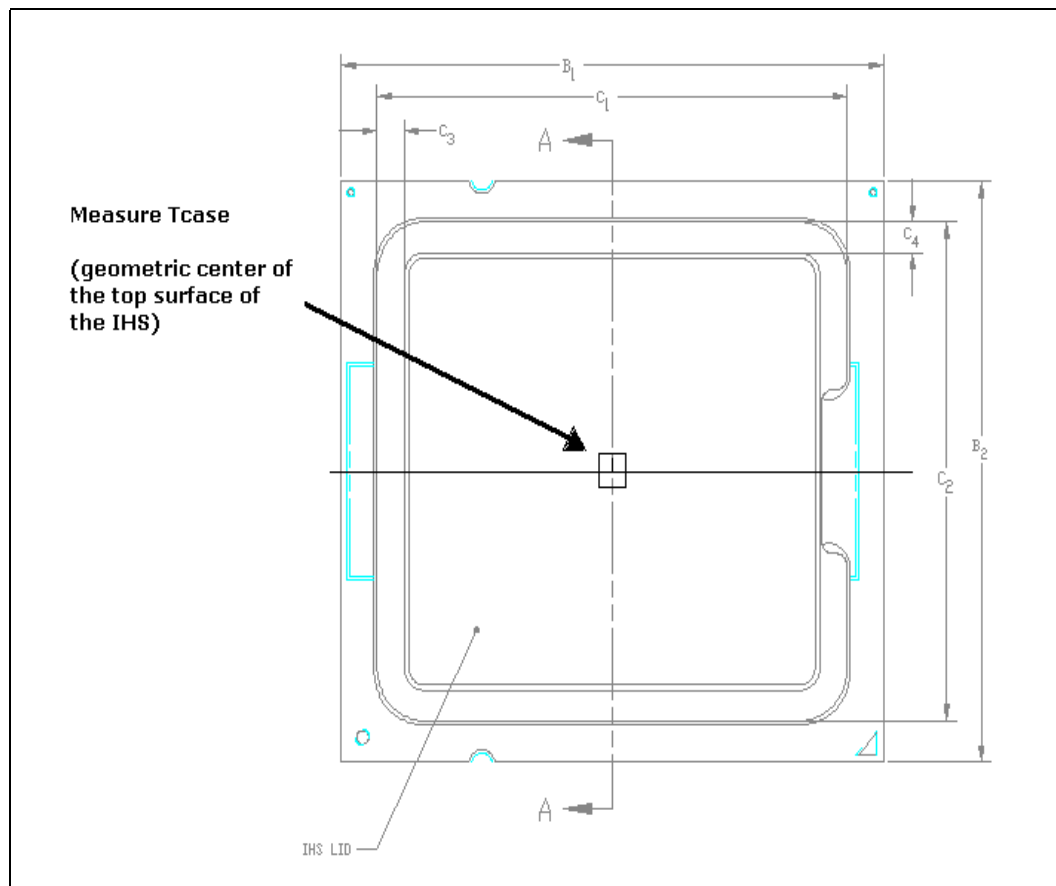
1. These values are specified at V<sub>CC\_MAX</sub> for all processor frequencies. Systems must be designed to ensure the processor is not to be subjected to any static V<sub>CC</sub> and I<sub>CC</sub> combination wherein V<sub>CC</sub> exceeds V<sub>CC\_MAX</sub> at specified I<sub>CC</sub>. Please refer to the loadline specifications in Section 2.6.

2. Thermal Design Power (TDP) should be used for processor thermal solution design targets. TDP is not the maximum power that the processor can dissipate. TDP is measured at maximum  $T_{CASE}$ .
3. These specifications are based on initial silicon characterization. These specifications may be further updated as more characterization data becomes available.
4. Power specifications are defined at all VIDs found in Table 2-2. The Intel Xeon Processor L5508 may be shipped under multiple VIDs for each frequency.
5. FMB, or Flexible Motherboard, guidelines provide a design target for meeting all planned processor frequency requirements.

## 6.1.2 Thermal Metrology

The minimum and maximum case temperatures ( $T_{CASE}$ ) are specified in Table 6-6, through Table 6-13 and are measured at the geometric top center of the processor integrated heat spreader (IHS). Figure 6-7 illustrates the location where  $T_{CASE}$  temperature measurements should be made. For detailed guidelines on temperature measurement methodology, refer to the *Intel® Xeon® Processor 5500/5600 Series Thermal / Mechanical Design Guide*.

Figure 6-7. Case Temperature ( $T_{CASE}$ ) Measurement Location



**Notes:**

1. Figure is not to scale and is for reference only.
2. B1: Max = 45.07 mm, Min = 44.93 mm.
3. B2: Max = 42.57 mm, Min = 42.43 mm.
4. C1: Max = 39.1 mm, Min = 38.9 mm.
5. C2: Max = 36.6 mm, Min = 36.4 mm.
6. C3: Max = 2.3 mm, Min = 2.2 mm.
7. C4: Max = 2.3 mm, Min = 2.2 mm.



## 6.2 Processor Thermal Features

### 6.2.1 Processor Temperature

A new feature in the Intel Xeon processor 5500 series is a software readable field in the IA32\_TEMPERATURE\_TARGET register that contains the minimum temperature at which the TCC will be activated and PROCHOT# will be asserted. The TCC activation temperature is calibrated on a part-by-part basis and normal factory variation may result in the actual TCC activation temperature being higher than the value listed in the register. TCC activation temperatures may change based on processor stepping, frequency or manufacturing efficiencies.

**Note:** There is no specified correlation between DTS temperatures and processor case temperatures; therefore it is not possible to use this feature to ensure the processor case temperature meets the Thermal Profile specifications.

### 6.2.2 Adaptive Thermal Monitor

The Adaptive Thermal Monitor feature provides an enhanced method for controlling the processor temperature when the processor silicon reaches its maximum operating temperature. Adaptive Thermal Monitor uses Thermal Control Circuit (TCC) activation to reduce processor power via a combination of methods. The first method (Frequency/VID control) involves the processor adjusting its operating frequency (via the core ratio multiplier) and input voltage (via the VID signals). This combination of reduced frequency and VID results in a reduction to the processor power consumption. The second method (clock modulation) reduces power consumption by modulating (starting and stopping) the internal processor core clocks. The processor intelligently selects the appropriate TCC method to use on a dynamic basis. BIOS is not required to select a specific method (as with previous-generation processors supporting TM1 or TM2).

**The Adaptive Thermal Monitor feature must be enabled for the processor to be operating within specifications.** The temperature at which Adaptive Thermal Monitor activates the Thermal Control Circuit is not user configurable and is not software visible. Snooping and interrupt processing are performed in the normal manner while the TCC is active.

With a properly designed and characterized thermal solution, it is anticipated that the TCC would only be activated for very short periods of time when running the most power intensive applications. The processor performance impact due to these brief periods of TCC activation is expected to be so minor that it would be immeasurable. An under-designed thermal solution that is not able to prevent excessive activation of the TCC in the anticipated ambient environment may cause a noticeable performance loss, and in some cases may result in a  $T_c$  that exceeds the specified maximum temperature which may affect the long-term reliability of the processor. In addition, a thermal solution that is significantly under-designed may not be capable of cooling the processor even when the TCC is active continuously. Refer to the appropriate Thermal/Mechanical Design Guide for information on designing a compliant thermal solution.

The duty cycle for the TCC, when activated by the Thermal Monitor, is factory configured and cannot be modified. The Thermal Monitor does not require any additional hardware, software drivers, or interrupt handling routines.

The following sections provide more details on the different TCC mechanisms used by Intel Xeon processor 5500 series.

### 6.2.2.1 Frequency/VID Control

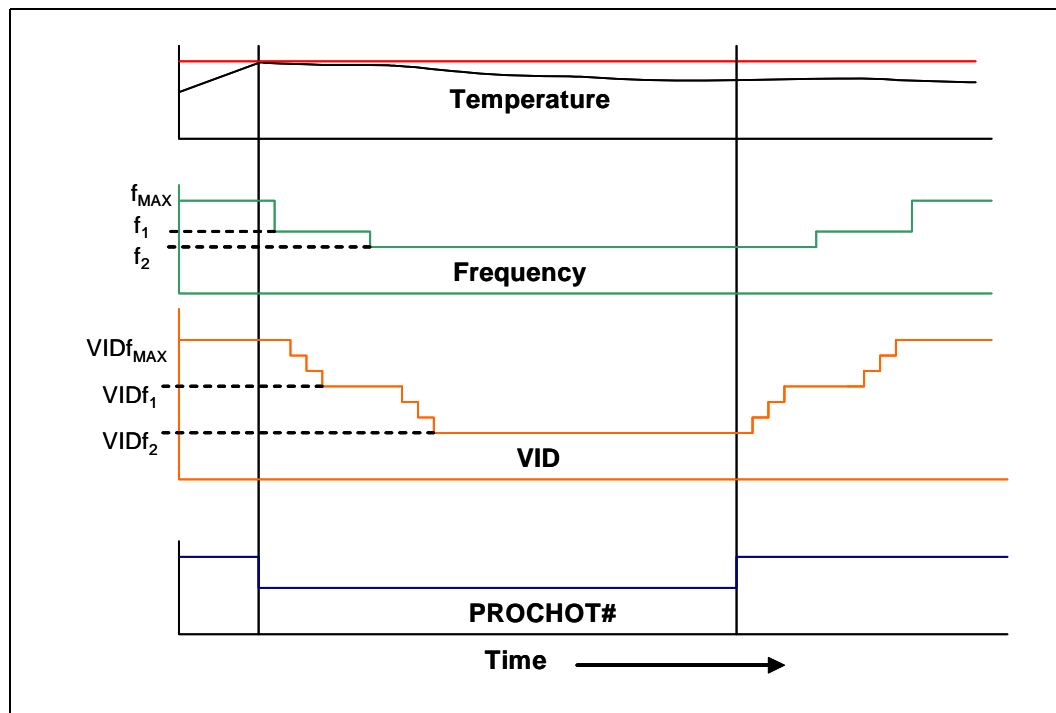
The processor uses Frequency/VID control whereby TCC activation causes the processor to adjust its operating frequency (via the core ratio multiplier) and input voltage (via the VID signals). This combination of reduced frequency and VID results in a reduction to the processor power consumption.

This method includes multiple operating points, each consisting of a specific operating frequency and voltage. The first operating point represents the normal operating condition for the processor. The remaining points consist of both lower operating frequencies and voltages. When the TCC is activated, the processor automatically transitions to the new operating frequency. This transition occurs very rapidly (on the order of 2  $\mu$ s).

Once the new operating frequency is engaged, the processor will transition to the new core operating voltage by issuing a new VID code to the voltage regulator. The voltage regulator must support dynamic VID steps to support this method. During the voltage change, it will be necessary to transition through multiple VID codes to reach the target operating voltage. Each step will be one VID table entry (see [Table 2-2](#)). The processor continues to execute instructions during the voltage transition. Operation at the lower voltages reduces the power consumption of the processor.

A small amount of hysteresis has been included to prevent rapid active/inactive transitions of the TCC when the processor temperature is near its maximum operating temperature. Once the temperature has dropped below the maximum operating temperature, and the hysteresis timer has expired, the operating frequency and voltage transition back to the normal system operating point via the intermediate VID/frequency points. Transition of the VID code will occur first, to insure proper operation once the processor reaches its normal operating frequency. Refer to [Figure 6-8](#) for an illustration of this ordering.

**Figure 6-8. Frequency and Voltage Ordering**







### 6.2.2.2 Clock Modulation

Clock modulation is performed by alternately turning the clocks off and on at a duty cycle specific to the processor (factory configured to 37.5% on and 62.5% off). The period of the duty cycle is configured to 32 microseconds when the TCC is active. Cycle times are independent of processor frequency. A small amount of hysteresis has been included to prevent rapid active/inactive transitions of the TCC when the processor temperature is near its maximum operating temperature. Once the temperature has dropped below the maximum operating temperature, and the hysteresis timer has expired, the TCC goes inactive and clock modulation ceases. Clock modulation is automatically engaged as part of the TCC activation when the Frequency/VID targets are at their minimum settings. It may also be initiated by software at a configurable duty cycle.

### 6.2.3 On-Demand Mode

The processor provides an auxiliary mechanism that allows system software to force the processor to reduce its power consumption. This mechanism is referred to as “On-Demand” mode and is distinct from the Adaptive Thermal Monitor feature. On-Demand mode is intended as a means to reduce system level power consumption. Systems utilizing the Intel Xeon processor 5500 series must not rely on software usage of this mechanism to limit the processor temperature. If bit 4 of the IA32\_CLOCK\_MODULATION MSR is set to a ‘1’, the processor will immediately reduce its power consumption via modulation (starting and stopping) of the internal core clock, independent of the processor temperature. When using On-Demand mode, the duty cycle of the clock modulation is programmable via bits 3:1 of the same IA32\_CLOCK\_MODULATION MSR. In On-Demand mode, the duty cycle can be programmed from 12.5% on/ 87.5% off to 87.5% on/12.5% off in 12.5% increments. On-Demand mode may be used in conjunction with the Adaptive Thermal Monitor; however, if the system tries to enable On-Demand mode at the same time the TCC is engaged, the factory configured duty cycle of the TCC will override the duty cycle selected by the On-Demand mode.

### 6.2.4 PROCHOT# Signal

An external signal, PROCHOT# (processor hot), is asserted when the processor core temperature has reached its maximum operating temperature. If Adaptive Thermal Monitor is enabled (note it must be enabled for the processor to be operating within specification), the TCC will be active when PROCHOT# is asserted. The processor can be configured to generate an interrupt upon the assertion or de-assertion of PROCHOT#.

The PROCHOT# signal is bi-directional in that it can either signal when the processor (any core) has reached its maximum operating temperature or be driven from an external source to activate the TCC. The ability to activate the TCC via PROCHOT# can provide a means for thermal protection of system components.

As an output, PROCHOT# will go active when the processor temperature monitoring sensor detects that one or more cores has reached its maximum safe operating temperature. This indicates that the processor Thermal Control Circuit (TCC) has been activated, if enabled. As an input, assertion of PROCHOT# by the system will activate the TCC, if enabled, for all cores. TCC activation due to PROCHOT# assertion by the system will result in the processor immediately transitioning to the minimum frequency and corresponding voltage (using Freq/VID control). Clock modulation is not activated in this case. The TCC will remain active until the system de-asserts PROCHOT#.



PROCHOT# can allow VR thermal designs to target maximum sustained current instead of maximum current. Systems should still provide proper cooling for the VR, and rely on PROCHOT# only as a backup in case of system cooling failure. The system thermal design should allow the power delivery circuitry to operate within its temperature specification even while the processor is operating at its Thermal Design Power.

With a properly designed and characterized thermal solution, it is anticipated that PROCHOT# will only be asserted for very short periods of time when running the most power intensive applications. An under-designed thermal solution that is not able to prevent excessive assertion of PROCHOT# in the anticipated ambient environment may cause a noticeable performance loss. Refer to the appropriate platform design guide and for details on implementing the bi-directional PROCHOT# feature.

### 6.2.5 THERMTRIP# Signal

Regardless of whether Adaptive Thermal Monitor is enabled, in the event of a catastrophic cooling failure, the processor will automatically shut down when the silicon has reached an elevated temperature (refer to the THERMTRIP# definition in [Table 5-1](#)). THERMTRIP# activation is independent of processor activity and does not generate any Intel® QuickPath Interconnect transactions. The temperature at which THERMTRIP# asserts is not user configurable and is not software visible.

## 6.3 Platform Environment Control Interface (PECI)

The Platform Environment Control Interface (PECI) uses a single wire for self-clocking and data transfer. The bus requires no additional control lines. The physical layer is a self-clocked one-wire bus that begins each bit with a driven, rising edge from an idle level near zero volts. The duration of the signal driven high depends on whether the bit value is a logic '0' or logic '1'. PEFI also includes variable data transfer rate established with every message. In this way, it is highly flexible even though underlying logic is simple.

The interface design was optimized for interfacing to Intel processor and chipset components in both single processor and multiple processor environments. The single wire interface provides low board routing overhead for the multiple load connections in the congested routing area near the processor and chipset components. Bus speed, error checking, and low protocol overhead provides adequate link bandwidth and reliability to transfer critical device operating conditions and configuration information.

The PEFI bus offers:

- A wide speed range from 2 Kbps to 2 Mbps
- CRC check byte used to efficiently and atomically confirm accurate data delivery
- Synchronization at the beginning of every message minimizes device timing accuracy requirements

**Note that the PEFI commands described in this document apply to the Intel Xeon processor 5500 series only. Refer to [Table 6-14](#) for the list of PEFI commands supported by the Intel Xeon processor 5500 series PEFI client.**


**Table 6-14. Summary of Processor-specific PECI Commands**

Command	Supported on Intel Xeon Processor 5500 Series CPU
Ping()	Yes
GetDIB()	Yes
GetTemp()	Yes
PCIConfigRd()	Yes
PCIConfigWr()	Yes
MbxSend() <sup>1</sup>	Yes
MbxGet() <sup>1</sup>	Yes

**Note:**

1. Refer to [Table 6-19](#) for a summary of mailbox commands supported by the Intel Xeon processor 5500 series CPU.

### 6.3.1 PECI Client Capabilities

The Intel Xeon processor 5500 series PECI client is designed to support the following sideband functions:

- Processor and DRAM thermal management
- Platform manageability functions including thermal, power and electrical error monitoring
- Processor interface tuning and diagnostics capabilities (Intel® Interconnect BIST [Intel® IBIST]).

#### 6.3.1.1 Thermal Management

Processor fan speed control is managed by comparing PECI thermal readings against the processor-specific fan speed control reference point, or  $T_{\text{CONTROL}}$ . Both  $T_{\text{CONTROL}}$  and PECI thermal readings are accessible via the processor PECI client. These variables are referenced to a common temperature, the TCC activation point, and are both defined as negative offsets from that reference. Algorithms for fan speed management using PECI thermal readings and the  $T_{\text{CONTROL}}$  reference are documented in [Section 6.3.2.6](#).

PECI-based access to DRAM thermal readings and throttling control coefficients provide a means for Board Management Controllers (BMCs) or other platform management devices to feed hints into on-die memory controller throttling algorithms. These control coefficients are accessible using PCI configuration space writes via PECI. The PECI-based configuration write functionality is defined in [Section 6.3.2.5](#), and the DRAM throttling coefficient control functions are documented in the *Intel® Xeon® Processor 5500 Series Datasheet, Volume 2*.

#### 6.3.1.2 Platform Manageability

PECI allows full read access to error and status monitoring registers within the processor's PCI configuration space. It also provides insight into thermal monitoring functions such as TCC activation timers and thermal error logs.

The exact list of RAS-related registers in the PCI configuration space can be found in the *Intel® Xeon® Processor 5500 Series Datasheet, Volume 2*.

### 6.3.1.3 Processor Interface Tuning and Diagnostics

Intel Xeon processor 5500 series Intel IBIST allows for in-field diagnostic capabilities in Intel QuickPath Interconnect and memory controller interfaces. PECEI provides a port to execute these diagnostics via its PCI Configuration read and write capabilities.

## 6.3.2 Client Command Suite

### 6.3.2.1 Ping()

Ping() is a required message for all PECEI devices. This message is used to enumerate devices or determine if a device has been removed, been powered-off, etc. A Ping() sent to a device address always returns a non-zero Write FCS if the device at the targeted address is able to respond.

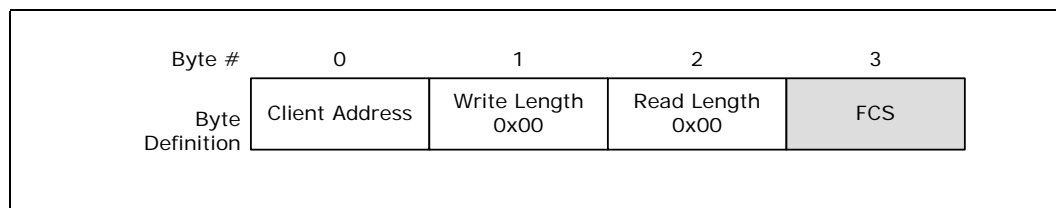
#### 6.3.2.1.1 Command Format

The Ping() format is as follows:

**Write Length:** 0

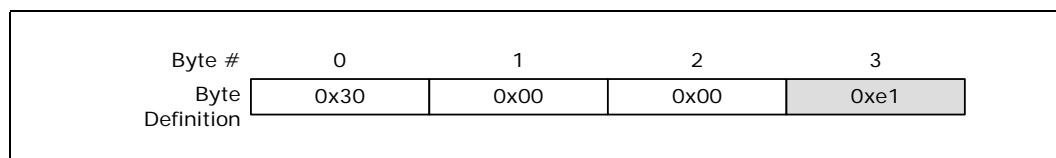
**Read Length:** 0

Figure 6-9. Ping()



An example Ping() command to PECEI device address 0x30 is shown below.

Figure 6-10. Ping() Example



### 6.3.2.2 GetDIB()

The processor PECEI client implementation of GetDIB() includes an 8-byte response and provides information regarding client revision number and the number of supported domains. All processor PECEI clients support the GetDIB() command.

#### 6.3.2.2.1 Command Format

The GetDIB() format is as follows:

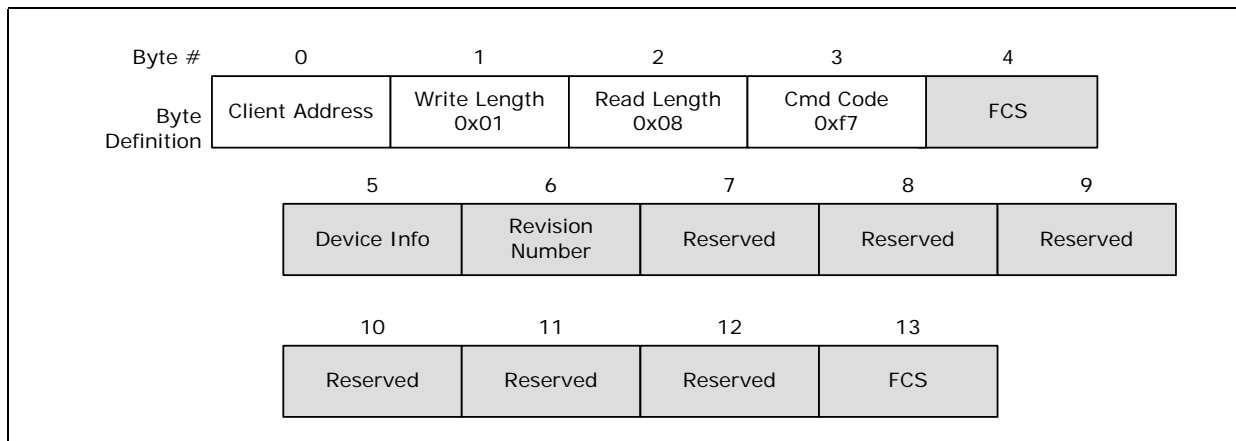
**Write Length:** 1

**Read Length:** 8

**Command:** 0xf7



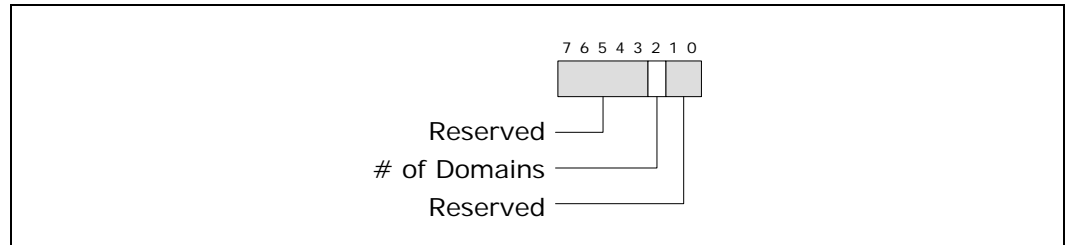
Figure 6-11. GetDIB()



6.3.2.2.2 Device Info

The Device Info byte gives details regarding the PECE client configuration. At a minimum, all clients supporting GetDIB will return the number of domains inside the package via this field. With any client, at least one domain (Domain 0) must exist. Therefore, the Number of Domains reported is defined as the number of domains in addition to Domain 0. For example, if the number 0b1 is returned, that would indicate that the PECE client supports two domains.

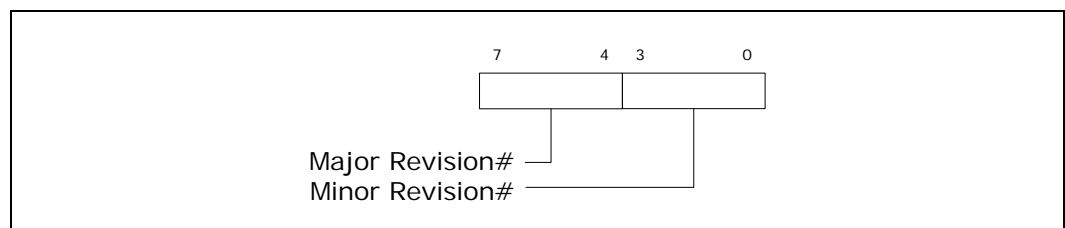
Figure 6-12. Device Info Field Definition



6.3.2.2.3 Revision Number

All clients that support the GetDIB command also support Revision Number reporting. The revision number may be used by a host or originator to manage different command suites or response codes from the client. Revision Number is always reported in the second byte of the GetDIB() response. The Revision Number always maps to the revision number of this document.

Figure 6-13. Revision Number Definition



For a client that is designed to meet the specification, the Revision Number it returns will be '0010 0000b'.

### 6.3.2.3 GetTemp()

The GetTemp() command is used to retrieve the temperature from a target PECI address. The temperature is used by the external thermal management system to regulate the temperature on the die. The data is returned as a negative value representing the number of degrees centigrade below the Thermal Control Circuit Activation temperature of the PECI device. Note that a value of zero represents the temperature at which the Thermal Control Circuit activates. The actual value that the thermal management system uses as a control set point (Tcontrol) is also defined as a negative number below the Thermal Control Circuit Activation temperature. TCONTROL may be extracted from the processor by issuing a PECI Mailbox MbxGet() (see Section 6.3.2.8), or using a RDMSR instruction.

Please refer to Section 6.3.6 for details regarding temperature data formatting.

#### 6.3.2.3.1 Command Format

The GetTemp() format is as follows:

**Write Length:** 1

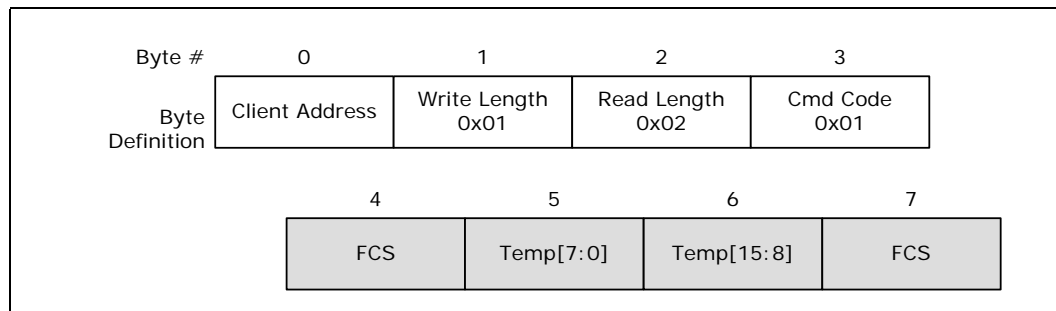
**Read Length:** 2

**Command:** 0x01

**Multi-Domain Support:** Yes (see Table 6-26)

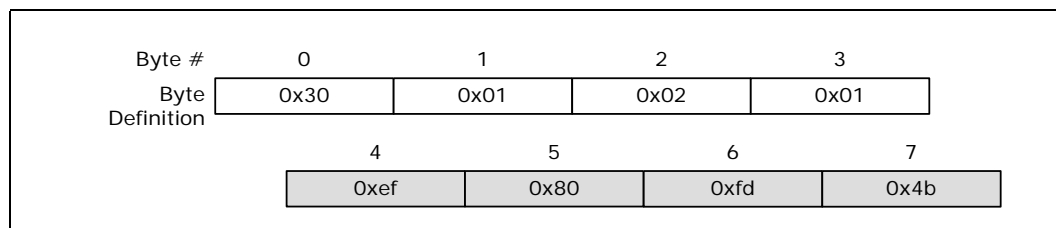
**Description:** Returns the current temperature for addressed processor PECI client.

Figure 6-14. GetTemp()



Example bus transaction for a thermal sensor device located at address 0x30 returning a value of negative 10°C:

Figure 6-15. GetTemp() Example





### 6.3.2.3.2 Supported Responses

The typical client response is a passing FCS and good thermal data. Under some conditions, the client's response will indicate a failure.

**Table 6-15. GetTemp() Response Definition**

Response	Meaning
General Sensor Error (GSE)	Thermal scan did not complete in time. Retry is appropriate.
0x0000	Processor is running at its maximum temperature or is currently being reset.
All other data	Valid temperature reading, reported as a negative offset from the TCC activation temperature.

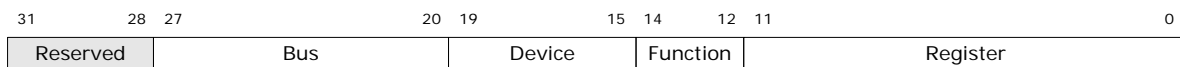
### 6.3.2.4 PCIConfigRd()

The PCIConfigRd() command gives sideband read access to the entire PCI configuration space maintained in the processor. This capability does not include support for route-through to downstream devices or sibling processors. The exact listing of supported devices, functions, and registers can be found in the *Intel® Xeon® Processor 5500 Series Datasheet, Volume 2*. PECE originators may conduct a device/function/register enumeration sweep of this space by issuing reads in the same manner that BIOS would. A response of all 1's indicates that the device/function/register is unimplemented.

PCI configuration addresses are constructed as shown in the following diagram. Under normal in-band procedures, the Bus number (including any reserved bits) would be used to direct a read or write to the proper device. Since there is a one-to-one mapping between any given client address and the bus number, any request made with a bad Bus number is ignored and the client will respond with a 'pass' completion code but all 0's in the data. The only legal bus number is 0x00. The client will return all 1's in the data response and 'pass' for the completion code for all of the following conditions:

- Unimplemented Device
- Unimplemented Function
- Unimplemented Register

**Figure 6-16. PCI Configuration Address**



PCI configuration reads may be issued in byte, word, or dword granularities.

#### 6.3.2.4.1 Command Format

The PCIConfigRd() format is as follows:

**Write Length:** 5

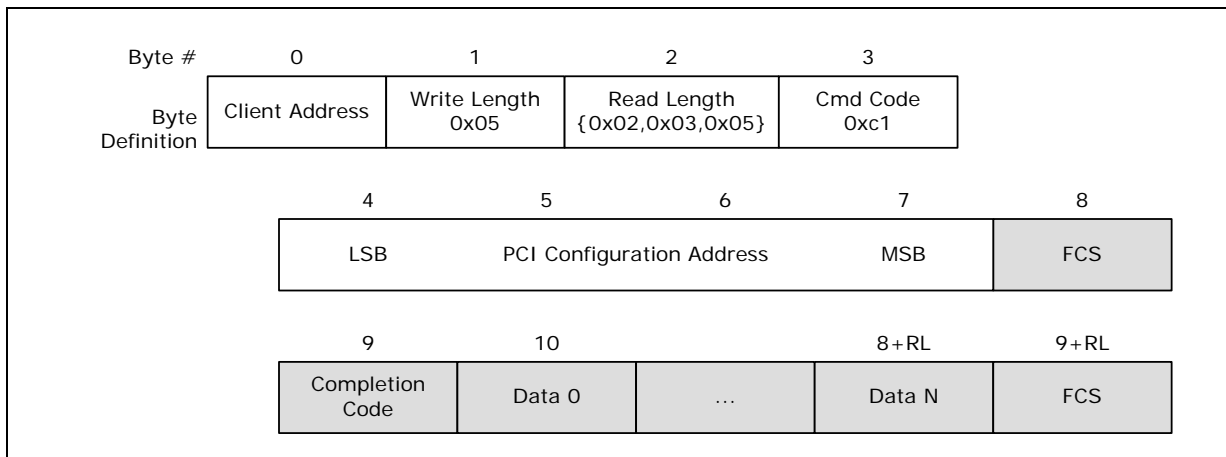
**Read Length:** 2 (byte data), 3 (word data), 5 (dword data)

**Command:** 0xc1

**Multi-Domain Support:** Yes (see [Table 6-26](#))

**Description:** Returns the data maintained in the PCI configuration space at the PCI configuration address sent. The Read Length dictates the desired data return size. This command supports byte, word, and dword responses as well as a completion code. All command responses are prepended with a completion code that includes additional pass/fail status information. Refer to [Section 6.3.4.2](#) for details regarding completion codes.

**Figure 6-17. PCIConfigRd()**



Note that the 4-byte PCI configuration address defined above is sent in standard PECL ordering with LSB first and MSB last.

**6.3.2.4.2 Supported Responses**

The typical client response is a passing FCS, a passing Completion Code (CC) and valid Data. Under some conditions, the client’s response will indicate a failure.

**Table 6-16. PCIConfigRd() Response Definition**

Response	Meaning
Abort FCS	Illegal command formatting (mismatched RL/WL/Command Code)
CC: 0x40	Command passed, data is valid
CC: 0x80	Error causing a response timeout. Either due to a rare, internal timing condition or a processor RESET or processor S1 state. Retry is appropriate outside of the RESET or S1 states.

**6.3.2.5 PCIConfigWr()**

The PCIConfigWr() command gives sideband write access to the PCI configuration space maintained in the processor. The exact listing of supported devices, functions is defined below in [Table 6-17](#). PECL originators may conduct a device/function/register enumeration sweep of this space by issuing reads in the same manner that BIOS would.





**Table 6-17. PCIConfigWr() Device/Function Support**

Writable		Description
Device	Function	
2	1	Intel QuickPath Interconnect Link 0 Intel IBIST
2	5	Intel QuickPath Interconnect Link 1 Intel IBIST
3	4	Memory Controller Intel IBIST <sup>1</sup>
4	3	Memory Controller Channel 0 Thermal Control / Status
5	3	Memory Controller Channel 1 Thermal Control / Status
6	3	Memory Controller Channel 2 Thermal Control / Status

**Notes:**

1. Currently not available for access through the PECI PCIConfigWr() command.

PCI configuration addresses are constructed as shown in [Figure 6-16](#), and this command is subject to the same address configuration rules as defined in [Section 6.3.2.4](#). PCI configuration reads may be issued in byte, word, or dword granularities.

Because a PCIConfigWr() results in an update to potentially critical registers inside the processor, it includes an Assured Write FCS (AW FCS) byte as part of the write data payload. In the event that the AW FCS mismatches with the client-calculated FCS, the client will abort the write and will always respond with a bad Write FCS.

**6.3.2.5.1 Command Format**

The PCIConfigWr() format is as follows:

**Write Length:** 7 (byte), 8 (word), 10 (dword)

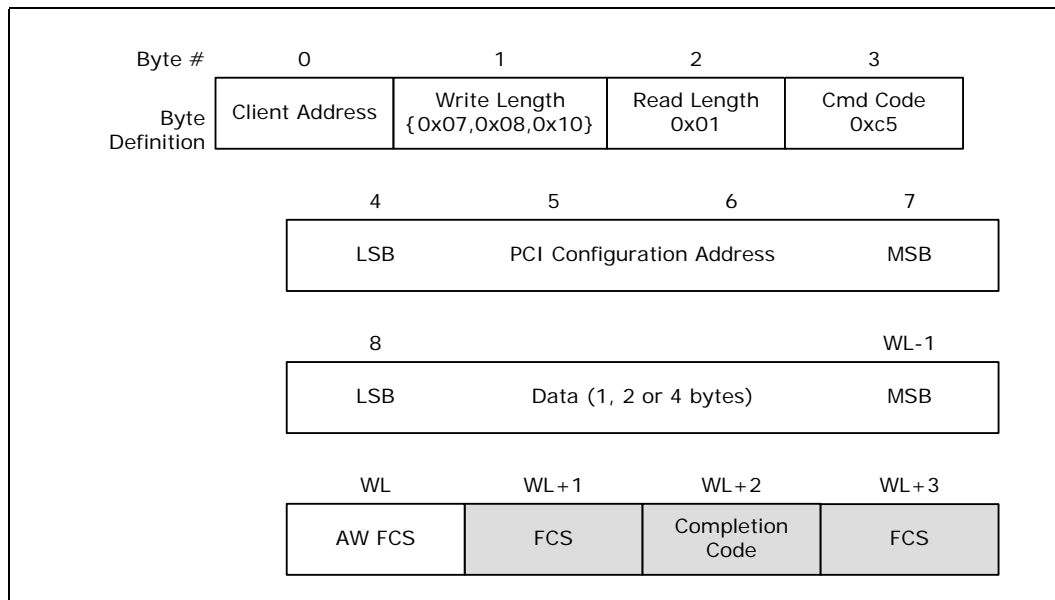
**Read Length:** 1

**Command:** 0xc5

**Multi-Domain Support:** Yes (see [Table 6-26](#))

**Description:** Writes the data sent to the requested register address. Write Length dictates the desired write granularity. The command always returns a completion code indicating the pass/fail status information. Write commands issued to illegal Bus Numbers, or unimplemented Device / Function / Register addresses are ignored but return a passing completion code. Refer to [Section 6.3.4.2](#) for details regarding completion codes.

Figure 6-18. PCIConfigWr()



Note that the 4-byte PCI configuration address and data defined above are sent in standard PECl ordering with LSB first and MSB last.

### 6.3.2.5.2 Supported Responses

The typical client response is a passing FCS, a passing Completion Code and valid Data. Under some conditions, the client’s response will indicate a failure.

Table 6-18. PCIConfigWr() Response Definition

Response	Meaning
Bad FCS	Electrical error or AW FCS failure
Abort FCS	Illegal command formatting (mismatched RL/WL/Command Code)
CC: 0x40	Command passed, data is valid
CC: 0x80	Error causing a response timeout. Either due to a rare, internal timing condition or a processor RESET condition or processor S1 state. Retry is appropriate outside of the RESET or S1 states.

### 6.3.2.6 Mailbox

The PECl mailbox (“Mbx”) is a generic interface to access a wide variety of internal processor states. A Mailbox request consists of sending a 1-byte request type and 4-byte data to the processor, followed by a 4-byte read of the response data. The following sections describe the Mailbox capabilities as well as the usage semantics for the MbxSend and MbxGet commands which are used to send and receive data.



### 6.3.2.6.1 Capabilities

**Table 6-19. Mailbox Command Summary**

Command Name	Request Type Code (byte)	MbxSend Data (dword)	MbxGet Data (dword)	Description
Ping	0x00	0x00	0x00	Verify the operability / existence of the Mailbox.
Thermal Status Read/Clear	0x01	Log bit clear mask	Thermal Status Register	Read the thermal status register and optionally clear any log bits. The thermal status has status and log bits indicating the state of processor TCC activation, external PROCHOT# assertion, and Critical Temperature threshold crossings.
Counter Snapshot	0x03	0x00	0x00	Snapshots all PECC-based counters
Counter Clear	0x04	0x00	0x00	Concurrently clear and restart all counters.
Counter Read	0x05	Counter Number	Counter Data	Returns the counter number requested. 0: Total reference time 1: Total TCC Activation time counter
Icc-TDC Read	0x06	0x00	Icc-TDC	Returns the specified Icc-TDC of this part, in Amps.
Thermal Config Data Read	0x07	0x00	Thermal config data	Reads the thermal averaging constant.
Thermal Config Data Write	0x08	Thermal Config Data	0x00	Writes the thermal averaging constant.
Tcontrol Read	0x09	0x00	Tcontrol	Reads the fan speed control reference temperature, Tcontrol, in PECC temperature format.
Machine Check Read	0x0A	Bank Number / Index	Register Data	Read CPU Machine Check Banks.
T-state Throttling Control Read	0xB	0x00	ACPI T-state Control Word	Reads the PECC ACPI T-state throttling control word.
T-state Throttling Control Write	0xC	ACPI T-state Control Word	0x00	Writes the PECC ACPI T-state throttling control word.

Any MbxSend request with a request type not defined in [Table 6-19](#) will result in a failing completion code.

More detailed command definitions follow.

#### 6.3.2.6.2 Ping

The Mailbox interface may be checked by issuing a Mailbox 'Ping' command. If the command returns a passing completion code, it is functional. Under normal operating conditions, the Mailbox Ping command should always pass.

#### 6.3.2.6.3 Thermal Status Read / Clear

The Thermal Status Read provides information on package level thermal status. Data includes:

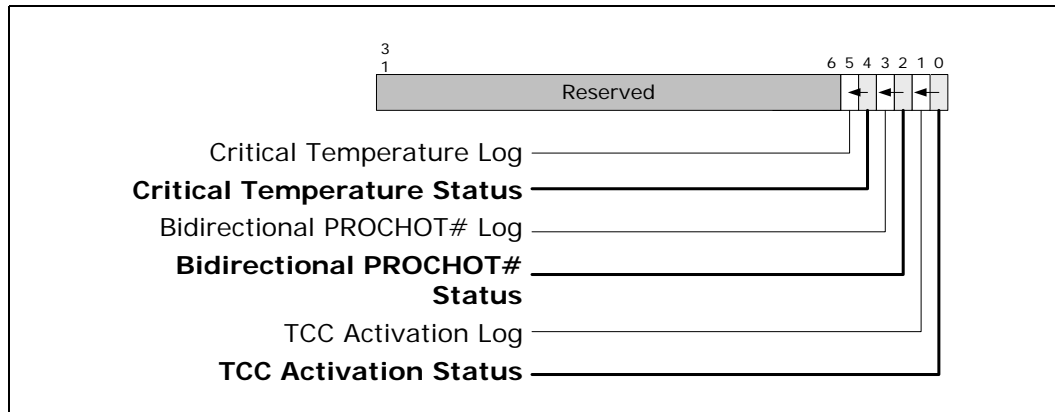
- The status of TCC activation
- Bidirectional PROCHOT# assertion
- Critical Temperature

These status bits are a subset of the bits defined in the IA32\_THERM\_STATUS MSR on the processor, and more details on the meaning of these bits may be found in the *Intel® 64 and IA-32 Architectures Software Developer's Manual*, Vol. 3B.

Both status and sticky log bits are managed in this status word. All sticky log bits are set upon a rising edge of the associated status bit, and the log bits are cleared only by Thermal Status reads or a processor reset. A read of the Thermal Status Word always includes a log bit clear mask that allows the host to clear any or all log bits that it is interested in tracking.

A bit set to 0b0 in the log bit clear mask will result in clearing the associated log bit. If a mask bit is set to 0b1 and that bit is not a legal mask, a failing completion code will be returned. A bit set to 0b1 is ignored and results in no change to any sticky log bits. For example, to clear the TCC Activation Log bit and retain all other log bits, the Thermal Status Read should send a mask of 0xFFFFFDD.

Figure 6-19. Thermal Status Word



6.3.2.6.4 Counter Snapshot / Read / Clear

A reference time and 'Thermally Constrained' time are managed in the processor. These two counters are managed via the Mailbox. These counters are valuable for detecting thermal runaway conditions where the TCC activation duty cycle reaches excessive levels.

The counters may be simultaneously snapshot, simultaneously cleared, or independently read. The simultaneous snapshot capability is provided in order to guarantee concurrent reads even with significant read latency over the PECL bus. Each counter is 32-bits wide.

Table 6-20. Counter Definition

Counter Name	Counter Number	Definition
Total Time	0x00	Counts the total time the processor has been executing with a resolution of approximately 1ms. This counter wraps at 32 bits.
Thermally Constrained Time	0x01	Counts the total time the processor has been operating at a lowered performance due to TCC activation. This timer includes the time required to ramp back up to the original P-state target after TCC activation expires. This timer does not include TCC activation time as a result of an external assertion of PROCHOT#.



**6.3.2.6.5 Icc-TDC Read**

Icc-TDC is the Intel Xeon processor 5500 series TDC current draw specification. This data may be used to confirm matching Icc profiles of processors in DP configurations. It may also be used during the processor boot sequence to verify processor compatibility with motherboard Icc delivery capabilities.

This command returns Icc-TDC in units of 1 Amp.

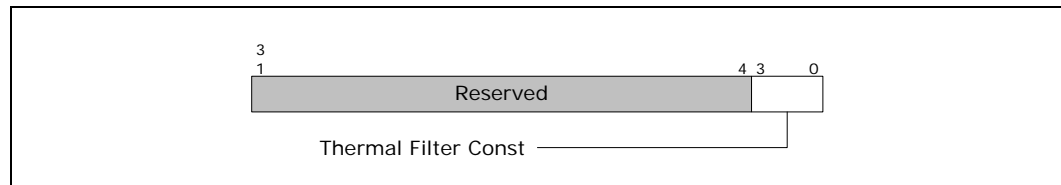
**6.3.2.6.6 TCONTROL Read**

TCONTROL is used for fan speed control management. The TCONTROL limit may be read over PECI using this Mailbox function. Unlike the in-band MSR interface, this TCONTROL value is already adjusted to be in the native PECI temperature format of a 2-byte, 2's complement number.

**6.3.2.6.7 Thermal Data Config Read / Write**

The Thermal Data Configuration register allows the PECI host to control the window over which thermal data is filtered. The default window is 256 ms. The host may configure this window by writing a Thermal Filtering Constant as a power of two. For example, sending a value of 9 results in a filtering window of  $2^9$  or 512 ms.

**Figure 6-20. Thermal Data Configuration Register**

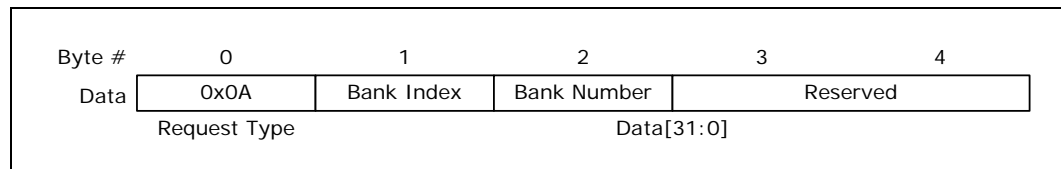


**6.3.2.6.8 Machine Check Read**

PECI offers read access to processor machine check banks 0, 1, 6 and 8.

Because machine check bank reads must be delivered through the Intel Xeon processor 5500 series Power Control Unit, it is possible that a fatal error in that unit will prevent access to other machine check banks. Host controllers may read Power Control Unit errors directly by issuing a PCIConfigRd() command of address 0x000000B0.

**Figure 6-21. Machine Check Read MbxSend() Data Format**





**Table 6-21. Machine Check Bank Definitions**

Bank Number	Bank Index	Meaning
0	0	MC0_CTL[31:0]
0	1	MC0_CTL[63:32]
0	2	MC0_STATUS[31:0]
0	3	MC0_STATUS[63:32]
0	4	MC0_ADDR[31:0]
0	5	MC0_ADDR[63:32]
0	6	MC0_MISC[31:0]
0	7	MC0_MISC[63:32]
1	0	MC1_CTL[31:0]
1	1	MC1_CTL[63:32]
1	2	MC1_STATUS[31:0]
1	3	MC1_STATUS[63:32]
1	4	MC1_ADDR[31:0]
1	5	MC1_ADDR[63:32]
1	6	MC1_MISC[31:0]
1	7	MC1_MISC[63:32]
6	0	MC6_CTL[31:0]
6	1	MC6_CTL[63:32]
6	2	MC6_STATUS[31:0]
6	3	MC6_STATUS[63:32]
6	4	MC6_ADDR[31:0]
6	5	MC6_ADDR[63:32]
6	6	MC6_MISC[31:0]
6	7	MC6_MISC[63:32]
8	0	MC8_CTL[31:0]
8	1	MC8_CTL[63:32]
8	2	MC8_STATUS[31:0]
8	3	MC8_STATUS[63:32]
8	4	MC8_ADDR[31:0]
8	5	MC8_ADDR[63:32]
8	6	MC8_MISC[31:0]
8	7	MC8_MISC[63:32]

**6.3.2.6.9 T-state Throttling Control Read / Write**

PECI offers the ability to enable and configure ACPI T-state (core clock modulation) throttling. ACPI T-state throttling forces all CPU cores into duty cycle clock modulation where the core toggles between C0 (clocks on) and C1 (clocks off) states at the specified duty cycle. This throttling reduces CPU performance to the duty cycle specified and, more importantly, results in processor power reduction.

The Intel Xeon processor 5500 series software initiated T-state throttling and automatic T-state throttling as part of the internal Thermal Monitor response mechanism (upon TCC activation). The PECI T-state throttling control register read/write capability is



managed only in the PECI domain. In-band software may not manipulate or read the PECI T-state control setting. In the event that multiple agents are requesting T-state throttling simultaneously, the CPU always gives priority to the lowest power setting, or the numerically lowest duty cycle.

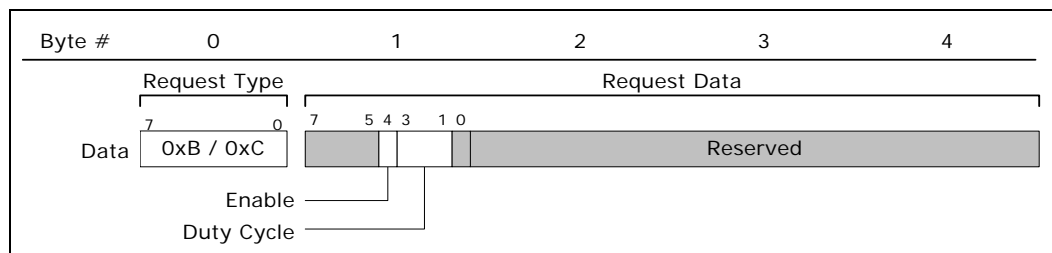
On Intel Xeon processor 5500 series, the only supported duty cycle is 12.5% (12.5% clocks on, 87.5% clocks off). It is expected that T-state throttling will be engaged only under emergency thermal or power conditions. Future products may support more duty cycles, as defined in the following table:

**Table 6-22. ACPI T-state Duty Cycle Definition**

Duty Cycle Code	Definition
0x0	Undefined
<b>0x1</b>	<b>12.5% clocks on / 87.5% clocks off</b>
0x2	25% clocks on / 75% clocks off
0x3	37.5% clocks on / 62.5% clocks off
0x4	50% clocks on / 50% clocks off
0x5	62.5% clocks on / 37.5% clocks off
0x6	75% clocks on / 25% clocks off
0x7	87.5% clocks on / 12.5% clocks off

The T-state control word is defined as follows:

**Figure 6-22. ACPI T-state Throttling Control Read / Write Definition**



### 6.3.2.7 MbxSend()

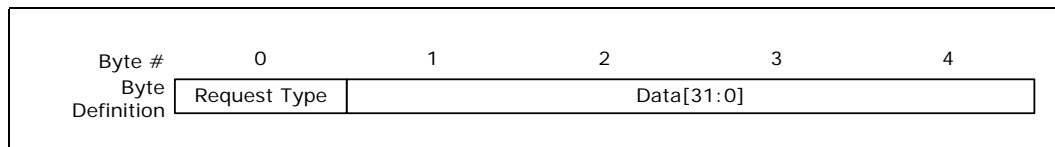
The MbxSend() command is utilized for sending requests to the generic Mailbox interface. Those requests are in turn serviced by the processor with some nominal latency and the result is deposited in the mailbox for reading. MbxGet() is used to retrieve the response and details are documented in [Section 6.3.2.8](#).

The details of processor mailbox capabilities are described in [Section 6.3.2.6.1](#), and many of the fundamental concepts of Mailbox ownership, release, and management are discussed in [Section 6.3.2.9](#).

#### 6.3.2.7.1 Write Data

Regardless of the function of the mailbox command, a request type modifier and 4-byte data payload must be sent. For Mailbox commands where the 4-byte data field is not applicable (for example, the command is a read), the data written should be all zeroes.

Figure 6-23. MbxSend() Command Data Format



Because a particular MbxSend() command may specify an update to potentially critical registers inside the processor, it includes an Assured Write FCS (AW FCS) byte as part of the write data payload. In the event that the AW FCS mismatches with the client-calculated FCS, the client will abort the write and will always respond with a bad Write FCS.

### 6.3.2.7.2 Command Format

The MbxSend() format is as follows:

**Write Length:** 7

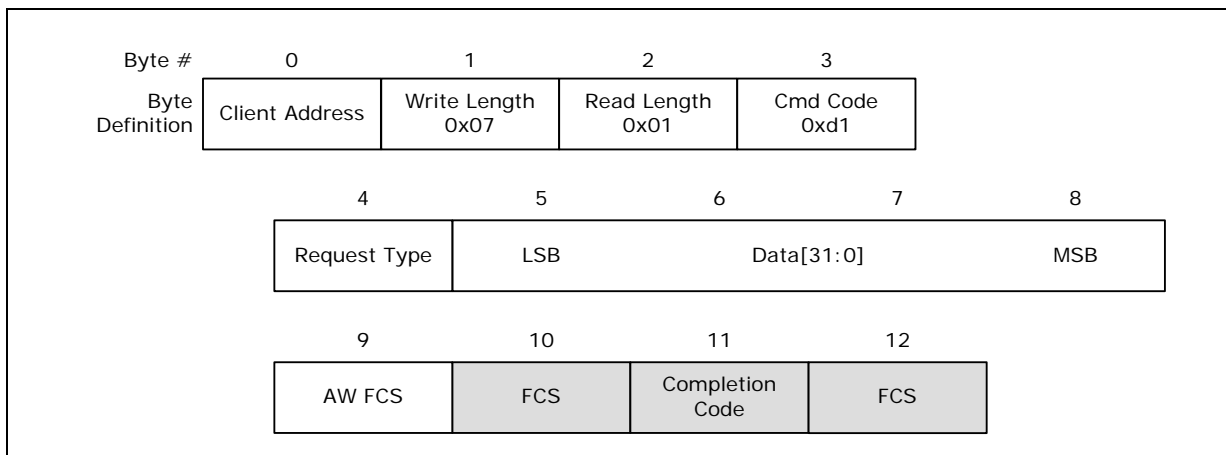
**Read Length:** 1

**Command:** 0xd1

**Multi-Domain Support:** Yes (see [Table 6-26](#))

**Description:** Deposits the Request Type and associated 4-byte data in the Mailbox interface and returns a completion code byte with the details of the execution results. Refer to [Section 6.3.4.2](#) for completion code definitions.

Figure 6-24. MbxSend()



Note that the 4-byte data defined above is sent in standard PECl ordering with LSB first and MSB last.





**Table 6-23. MbxSend() Response Definition**

Response	Meaning
Bad FCS	Electrical error
CC: 0x4X	Semaphore is granted with a Transaction ID of 'X'
CC: 0x80	Error causing a response timeout. Either due to a rare, internal timing condition or a processor RESET condition or processor S1 state. Retry is appropriate outside of the RESET or S1 states.
CC: 0x86	Mailbox interface is unavailable or busy

If the MbxSend() response returns a bad Read FCS, the completion code can't be trusted and the semaphore may or may not be taken. In order to clean out the interface, an MbxGet() must be issued and the response data should be discarded.

**6.3.2.8 MbxGet()**

The MbxGet() command is utilized for retrieving response data from the generic Mailbox interface as well as for unlocking the acquired mailbox. Please refer to [Section 6.3.2.7](#) for details regarding the MbxSend() command. Many of the fundamental concepts of Mailbox ownership, release, and management are discussed in [Section 6.3.2.9](#).

**6.3.2.8.1 Write Data**

The MbxGet() command is designed to retrieve response data from a previously deposited request. In order to guarantee alignment between the temporally separated request (MbxSend) and response (MbxGet) commands, the originally granted Transaction ID (sent as part of the passing MbxSend() completion code) must be issued as part of the MbxGet() request.

Any mailbox request made with an illegal or unlocked Transaction ID will get a failed completion code response. If the Transaction ID matches an outstanding transaction ID associated with a locked mailbox, the command will complete successfully and the response data will be returned to the originator.

Unlike MbxSend(), no Assured Write protocol is necessary for this command because this is a read-only function.

**6.3.2.8.2 Command Format**

The MbxGet() format is as follows:

**Write Length:** 2

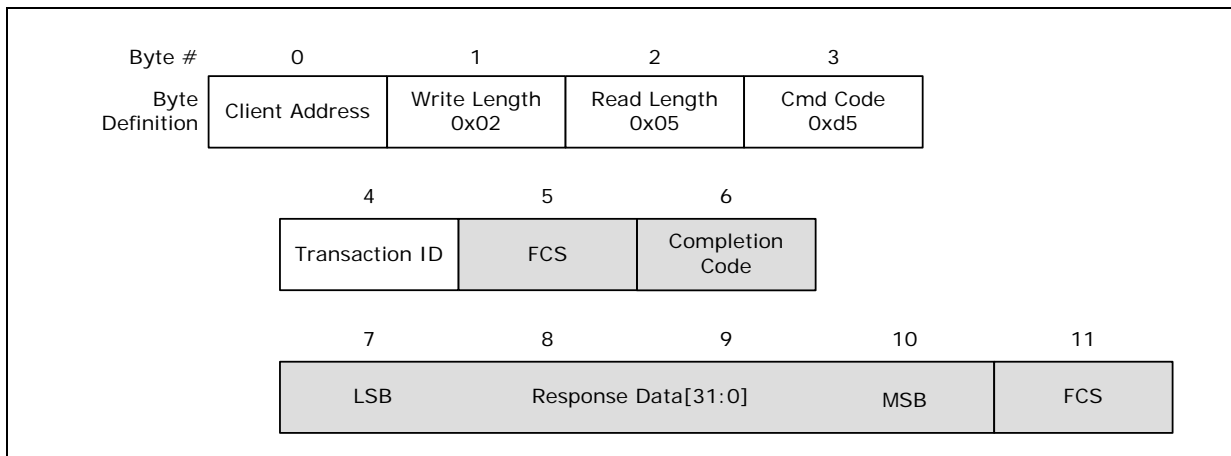
**Read Length:** 5

**Command:** 0xd5

**Multi-Domain Support:** Yes (see [Table 6-26](#))

**Description:** Retrieves response data from mailbox and unlocks / releases that mailbox resource.

Figure 6-25. MbxGet()



Note that the 4-byte data response defined above is sent in standard PECI ordering with LSB first and MSB last.

Table 6-24. MbxGet() Response Definition

Response	Meaning
Aborted Write FCS	Response data is not ready. Command retry is appropriate.
CC: 0x40	Command passed, data is valid
CC: 0x80	Error causing a response timeout. Either due to a rare, internal timing condition or a processor RESET condition or processor S1 state. Retry is appropriate outside of the RESET or S1 states.
CC: 0x81	Thermal configuration data was malformed or exceeded limits.
CC: 0x82	Thermal status mask is illegal
CC: 0x83	Invalid counter select
CC: 0x84	Invalid Machine Check Bank or Index
CC: 0x85	Failure due to lack of Mailbox lock or invalid Transaction ID
CC: 0x86	Mailbox interface is unavailable or busy
CC: 0xFF	Unknown/Invalid Mailbox Request

### 6.3.2.9 Mailbox Usage Definition

#### 6.3.2.9.1 Acquiring the Mailbox

The MbxSend() command is used to acquire control of the PECI mailbox and issue information regarding the specific request. The completion code response indicates whether or not the originator has acquired a lock on the mailbox, and that completion code always specifies the Transaction ID associated with that lock (see [Section 6.3.2.9.2](#)).

Once a mailbox has been acquired by an originating agent, future requests to acquire that mailbox will be denied with an 'interface busy' completion code response.

The lock on a mailbox is not achieved until the last bit of the MbxSend() Read FCS is transferred (in other words, it is not committed until the command completes). If the host aborts the command at any time prior to that bit transmission, the mailbox lock will be lost and it will remain available for any other agent to take control.



#### 6.3.2.9.2 Transaction ID

For all MbxSend() commands that complete successfully, the passing completion code (0x4X) includes a 4-bit Transaction ID ('X'). That ID is the key to the mailbox and must be sent when retrieving response data and releasing the lock by using the MbxGet() command.

The Transaction ID is generated internally by the processor and has no relationship to the originator of the request. On Intel Xeon processor 5500 series, only a single outstanding Transaction ID is supported. Therefore, it is recommended that all devices requesting actions or data from the Mailbox complete their requests and release their semaphore in a timely manner.

In order to accommodate future designs, software or hardware utilizing the PECI mailbox must be capable of supporting Transaction IDs between 0 and 15.

#### 6.3.2.9.3 Releasing the Mailbox

The mailbox associated with a particular Transaction ID is only unlocked / released upon successful transmission of the last bit of the Read FCS. If the originator aborts the transaction prior to transmission of this bit (presumably due to an FCS failure), the semaphore is maintained and the MbxGet() command may be retried.

#### 6.3.2.9.4 Mailbox Timeouts

The mailbox is a shared resource that can result in artificial bandwidth conflicts among multiple querying processes that are sharing the same originator interface. The interface response time is quick, and with rare exception, back to back MbxSend() and MbxGet() commands should result in successful execution of the request and release of the mailbox. In order to guarantee timely retrieval of response data and mailbox release, the mailbox semaphore has a timeout policy. If the PECI bus has a cumulative '0 time of 1ms since the semaphore was acquired, the semaphore is automatically cleared. In the event that this timeout occurs, the originating agent will receive a failed completion code upon issuing a MbxGet() command, or even worse, it may receive corrupt data if this MbxGet() command so happens to be interleaved with an MbxSend() from another process. Please refer to [Table 6-24](#) for more information regarding failed completion codes from MbxGet() commands.

Timeouts are undesirable, and the best way to avoid them and guarantee valid data is for the originating agent to always issue MbxGet() commands immediately following MbxSend() commands.

Alternately, mailbox timeout can be disabled. BIOS may write MSR MISC\_POWER\_MGMT (0x1AA), bit 11 to 0b1 in order to force a disable of this automatic timeout.

#### 6.3.2.9.5 Response Latency

The PECI mailbox interface is designed to have response data available within plenty of margin to allow for back-to-back MbxSend() and MbxGet() requests. However, under rare circumstances that are out of the scope of this specification, it is possible that the response data is not available when the MbxGet() command is issued. Under these circumstances, the MbxGet() command will respond with an Abort FCS and the originator should re-issue the MbxGet() request.



### 6.3.3 Multi-Domain Commands

The Intel Xeon processor 5500 series does not support multiple domains, but it is possible that future products will, and the following tables are included as a reference for domain-specific definitions.

Table 6-25. Domain ID Definition

Domain ID	Domain Number
0b01	0
0b10	1

Table 6-26. Multi-Domain Command Code Reference

Command Name	Domain 0 Code	Domain 1 Code
GetTemp()	0x01	0x02
PCIConfigRd()	0xC1	0xC2
PCIConfigWr()	0xC5	0xC6
MbxSend()	0xD1	0xD2
MbxGet()	0xD5	0xD6

### 6.3.4 Client Responses

#### 6.3.4.1 Abort FCS

The Client responds with an Abort FCS under the following conditions:

- The decoded command is not understood or not supported on this processor (this includes good command codes with bad Read Length or Write Length bytes).
- Data is not ready.
- Assured Write FCS (AW FCS) failure. Note that under most circumstances, an Assured Write failure will appear as a bad FCS. However, when an originator issues a poorly formatted command with a miscalculated AW FCS, the client will intentionally abort the FCS in order to guarantee originator notification.

#### 6.3.4.2 Completion Codes

Some PECL commands respond with a completion code byte. These codes are designed to communicate the pass/fail status of the command and also provide more detailed information regarding the class of pass or fail. For all commands listed in [Section 6.3.2](#) that support completion codes, each command's completion codes is listed in its respective section. What follows are some generalizations regarding completion codes.

An originator that is decoding these commands can apply a simple mask to determine pass or fail. Bit 7 is always set on a failed command, and is cleared on a passing command.

Table 6-27. Completion Code Pass/Fail Mask

0xxx xxxxb	Command passed
1xxx xxxxb	Command failed

**Table 6-28. Device Specific Completion Code (CC) Definition**

Completion Code	Description
0x00..0x3F	Device specific pass code
0x40	Command Passed
0x4X	Command passed with a transaction ID of 'X' (0x40   Transaction_ID[3:0])
0x50..0x7F	Device specific pass code
CC: 0x80	Error causing a response timeout. Either due to a rare, internal timing condition or a processor RESET condition or processor S1 state. Retry is appropriate outside of the RESET or S1 states.
CC: 0x81	Thermal configuration data was malformed or exceeded limits.
CC: 0x82	Thermal status mask is illegal
CC: 0x83	Invalid counter select
CC: 0x84	Invalid Machine Check Bank or Index
CC: 0x85	Failure due to lack of Mailbox lock or invalid Transaction ID
CC: 0x86	Mailbox interface is unavailable or busy
CC: 0xFF	Unknown/Invalid Mailbox Request

**Note:** The codes explicitly defined in this table may be useful in PECL originator response algorithms. All reserved or undefined codes may be generated by a PECL client device, and the originating agent must be capable of tolerating any code. The Pass/Fail mask defined in [Table 6-27](#) applies to all codes and general response policies may be based on that limited information.

### 6.3.5 Originator Responses

The simplest policy that an originator may employ in response to receipt of a failing completion code is to retry the request. However, certain completion codes or FCS responses are indicative of an error in command encoding and a retry will not result in a different response from the client. Furthermore, the message originator must have a response policy in the event of successive failure responses.

Please refer to the definition of each command in [Section 6.3.2](#) for a specific definition of possible command codes or FCS responses for a given command. The following response policy definition is generic, and more advanced response policies may be employed at the discretion of the originator developer.

**Table 6-29. Originator Response Guidelines**

Response	After 1 Attempt	After 3 attempts
Bad FCS	Retry	Fail with PECL client device error
Abort FCS	Retry	Fail with PECL client device error. May be due to illegal command codes.
CC: Fail	Retry	Either the PECL client doesn't support the current command code, or it has failed in its attempts to construct a response.
None (all 0's)	Force bus idle (1ms low), retry	Fail with PECL client device error. Client may be dead or otherwise non-responsive (in RESET or S1, for example).
CC: Pass	Pass	n/a
Good FCS	Pass	n/a



### 6.3.6 Temperature Data

#### 6.3.6.1 Format

The temperature is formatted in a 16-bit, 2's complement value representing a number of 1/64 degrees centigrade. This format allows temperatures in a range of ±512°C to be reported to approximately a 0.016°C resolution.

Figure 6-26. Temperature Sensor Data Format

MSB Upper nibble		MSB Lower nibble				LSB Upper nibble				LSB Lower nibble						
S	x	x	x	x	x	x	x	x	x	x	x	x	x	x		
Sign	Integer Value (0-511)								Fractional Value (-0.016)							

#### 6.3.6.2 Interpretation

The resolution of the processor's Digital Thermal Sensor (DTS) is approximately 1°C, which can be confirmed by a RDMSR from IA32\_THERM\_STATUS MSR (0x19C) where it is architecturally defined. PECI temperatures are sent through a configurable low-pass filter prior to delivery in the GetTemp() response data. The output of this filter produces temperatures at the full 1/64°C resolution even though the DTS itself is not this accurate.

Temperature readings from the processor are always negative in a 2's complement format, and imply an offset from the reference TCC activation temperature. As an example, assume that the TCC activation temperature reference is 100°C. A PECI thermal reading of -10 indicates that the processor is running approximately 10°C below the TCC activation temperature, or 90°C. PECI temperature readings are not reliable at temperatures above TCC activation (since the processor is operating out of specification at this temperature). Therefore, the readings are never positive.

#### 6.3.6.3 Temperature Filtering

The processor digital thermal sensor (DTS) provides an improved capability to monitor device hot spots, which inherently leads to more varying temperature readings over short time intervals. Coupled with the fact that typical fan speed controllers may only read temperatures at 4 Hz, it is necessary for the thermal readings to reflect thermal trends and not instantaneous readings. Therefore, PECI supports a configurable low-pass temperature filtering function. By default, this filter results in a thermal reading that is a moving average of 256 samples taken at approximately 1msec intervals. This filter's depth, or smoothing factor, may be configured to between 1 sample and 1024 samples, in powers of 2. See the equation below for reference where the configurable variable is 'X'.

$$T_N = T_{N-1} + 1/2^X * (T_{SAMPLE} - T_{N-1})$$

Please refer to [Section 6.3.2.6.7](#) for the definition of the thermal configuration command.



### 6.3.6.4 Reserved Values

Several values well out of the operational range are reserved to signal temperature sensor errors. These are summarized in the table below:

**Table 6-30. Error Codes and Descriptions**

Error Code	Description
0x8000	General Sensor Error (GSE)

## 6.3.7 Client Management

### 6.3.7.1 Power-up Sequencing

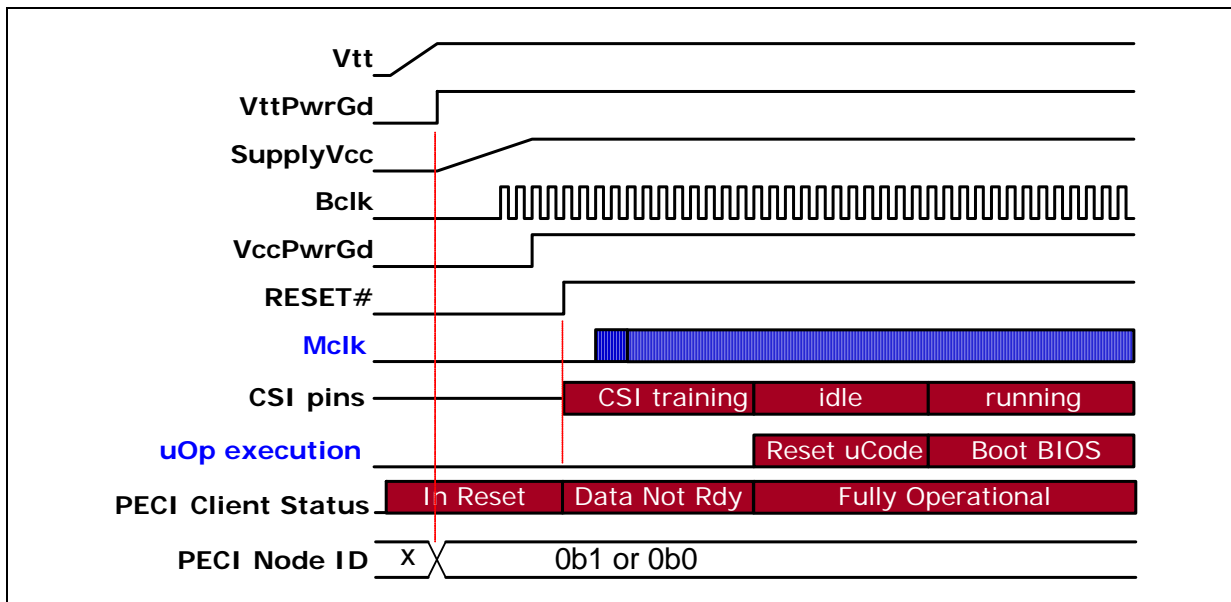
The PECI client is fully reset during processor RESET# assertion. This means that any transactions on the bus will be completely ignored, and the host will read the response from the client as all zeroes. After processor RESET# deassertion, the Intel Xeon processor 5500 series PECI client is operational enough to participate in timing negotiations and respond with reasonable data. However, the client data is not guaranteed to be fully populated until approximately 500 μS after processor RESET# is deasserted. Until that time, data may not be ready for all commands. The client responses to each command are as follows:

**Table 6-31. PECI Client Response During Power-Up (During 'Data Not Ready')**

Command	Response
Ping()	Fully functional
GetDIB()	Fully functional
GetTemp()	Client responds with a 'hot' reading, or 0x0000
PCIConfigRd()	Fully functional
PCIConfigWr()	Fully functional
MbxSend()	Fully functional
MbxGet()	Client responds with Abort FCS (if MbxSend() has been previously issued)

In the event that the processor is tri-stated using power-on-configuration controls, the PECI client will also be tri-stated. Processor tri-state controls are described in [Section 7](#).

Figure 6-27. PECE Power-up Timeline



### 6.3.7.2 Device Discovery

The PECE client is available on all processors, and positive identification of the PECE revision number can be achieved by issuing the GetDIB() command. Please refer to Section 6.3.2.2 for details on GetDIB response formatting.

### 6.3.7.3 Client Addressing

The PECE client assumes a default address of 0x30. If nothing special is done to the processor, all PECE clients will boot with this address. For DP enabled parts, a special PECE\_ID# pin is available to strap each PECE socket to a different node ID. The package pin strap is evaluated at the assertion of V<sub>CC</sub>PWRGOOD (as depicted in Figure 6-27). Since PECE\_ID# is active low, tying the pin to ground results in a client address of 0x31, and tying it to V<sub>TT</sub> results in a client address of 0x30.

The client address may not be changed after V<sub>CC</sub>PWRGOOD assertion, until the next power cycle on the processor. Removal of a processor from its socket or tri-stating a processor in a DP configuration will have no impact to the remaining non-tri-stated PECE client address.

### 6.3.7.4 C-States

The Intel Xeon processor 5500 series PECE client is fully functional under all core and package C-states. Support for package C-states is a function of processor SKU and platform capabilities. All package C-states (C1/C1E, C3, and C6) are annotated here for completeness, but actual processor support for these C-states may vary.

Because the Intel Xeon processor 5500 series takes aggressive power savings actions under the deepest C-states (C1/C1E, C3, and C6), PECE requests may have an impact to platform power. The impact is documented below:

- Ping(), GetDIB(), GetTemp() and MbxGet() have no measurable impact on processor power under C-states.





- MbxSend(), PCIConfigRd() and PCIConfigWr() usage under package C-states may result in increased power consumption because the processor must temporarily return to a C0 state in order to execute the request. The exact power impact of a pop-up to C0 varies by product SKU, the C-state from which the pop-up is initiated, and the negotiated T<sub>BIT</sub>.

**Table 6-32. Power Impact of PECI Commands versus C-states**

Command	Power Impact
Ping()	Not measurable
GetDIB()	Not measurable
GetTemp()	Not measurable
PCIConfigRd()	Requires a package 'pop-up' to a C0 state
PCIConfigWr()	Requires a package 'pop-up' to a C0 state
MbxSend()	Requires a package 'pop-up' to a C0 state
MbxGet()	Not measurable

**6.3.7.5 S-States**

The PECI client is always guaranteed to be operational under S0 and S1 sleep states. Under S3 and deeper sleep states, the PECI client response is undefined and therefore unreliable.

**Table 6-33. PECI Client Response During S1**

Command	Response
Ping()	Fully functional
GetDIB()	Fully functional
GetTemp()	Fully functional
PCIConfigRd()	Fully functional
PCIConfigWr()	Fully functional
MbxSend()	Fully functional
MbxGet()	Fully functional

**6.3.7.6 Processor Reset**

The Intel Xeon processor 5500 series PECI client is fully reset on all RESET# assertions. Upon deassertion of RESET#, where power is maintained to the processor (otherwise known as a 'warm reset'), the following are true:

- The PECI client assumes a bus Idle state.
- The Thermal Filtering Constant is retained.
- PECI Node ID is retained.
- GetTemp() reading resets to 0x0000.
- Any transaction in progress is aborted by the client (as measured by the client no longer participating in the response).
- The processor client is otherwise reset to a default configuration.

**§**





# 7 Features

## 7.1 Power-On Configuration (POC)

Several options can be configured by hardware. Power-On configuration (POC) functionality is provided by strapping VID signals (see [Table 2-3](#)) or sampled on the active-to-inactive transition of RESET#. For specifics on these options, please refer to [Table 7-1](#).

Please note that requests to execute Built-In Self Test (BIST) are not selected by hardware, but rather passed across the Intel QuickPath Interconnect link during initialization.

Processors sample VID[2:0]/MSID[2:0] and VID[5:3]/CSC[2:0] around the asserting edge VTPWRGOOD.

**Table 7-1. Power On Configuration Signal Options**

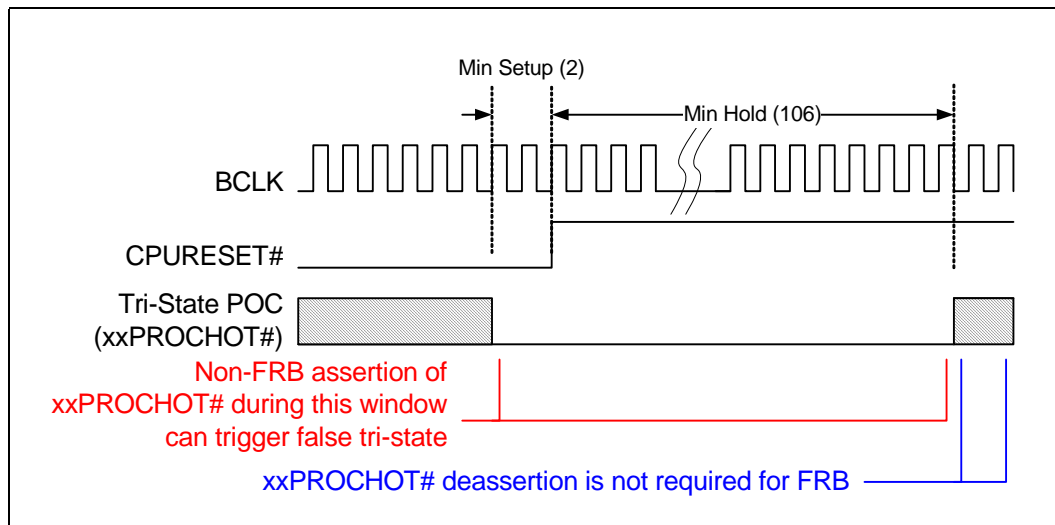
Configuration Option	Signal	Reference
Output tristate	PROCHOT# <sup>1</sup>	<a href="#">Section 6.2.4</a>
PECI ID	ODT/PECI_ID# <sup>2, 3</sup>	<a href="#">Section 6.3.7.3</a>
MSID	VID[2:0]/MSID[2:0] <sup>2, 3</sup>	<a href="#">Table 2-3</a>
CSC	VID[5:3]/CSC[2:0] <sup>2, 3</sup>	<a href="#">Table 2-3</a>

**Notes:**

1. Asserting this signal during RESET# de-assertion will select the corresponding option. Once selected, this option cannot be changed except via another reset. The processor does not distinguish between a "warm" reset and a "power-on" reset. Output tri-state via the PROCHOT# power-on configuration option is referred to as Fault Resilient Boot (FRB).
2. Latched when VTPWRGOOD is asserted and all internal power good conditions are met.
3. See the signal definitions in [Table 5-1](#) for the description of Peci\_ID#, MSID, and CSC.

Assertion of the PROCHOT# signal through RESET# de-assertion (also referred to as Fault Resilient Boot (FRB)) will tri-state processor outputs. [Figure 7-1](#) outlines timing requirements when utilizing PROCHOT# as a power-on configuration option. In the event an FRB is desired, PROCHOT# and RESET# should be asserted simultaneously. Furthermore, once asserted, PROCHOT# should remain low long enough to meet the Power-On Configuration Hold Time (PROCHOT#). Failure to do so may result in false tri-state.

Figure 7-1. PROCHOT# POC Timing Requirements



Power-On Configuration (POC) logic levels are MUX-ed onto the VID[7:0] signals with 1-5 K $\Omega$  pull-up and pull-down resistors located on the baseboard. These include:

- VID[2:0] / MSID[2:0] = Market Segment ID
- VID[5:3] / CSC[2:0] = Current Sense Configuration
- VID[6] = Reserved
- VID[7] = VR11.1 Select

Pull-up and pull-down resistors on the baseboard eliminate the need for timing specifications. After the voltage regulator's OUTEN signal is asserted, the VID[7:0] CMOS drivers (typically 50 $\Omega$  up / down impedance) override the POC pull-up / down resistors located on the baseboard and drive the necessary VID pattern. Please refer to Table 2-3 for further details.

## 7.2 Clock Control and Low Power States

The processor supports low power states at the individual thread, core, and package level for optimal power management. The processor implements software interfaces for requesting low power states: MWAIT instruction extensions with sub-state hints, the HLT instruction (for C1 and C1E) and P\_LVLx reads to the ACPI P\_BLK register block mapped in the processor's I/O address space. The P\_LVLx I/O reads are converted to equivalent MWAIT C-state requests inside the processor and do not directly result in I/O reads to the system. The P\_LVLx I/O Monitor address does not need to be set up before using the P\_LVLx I/O read interface.

**Note:**

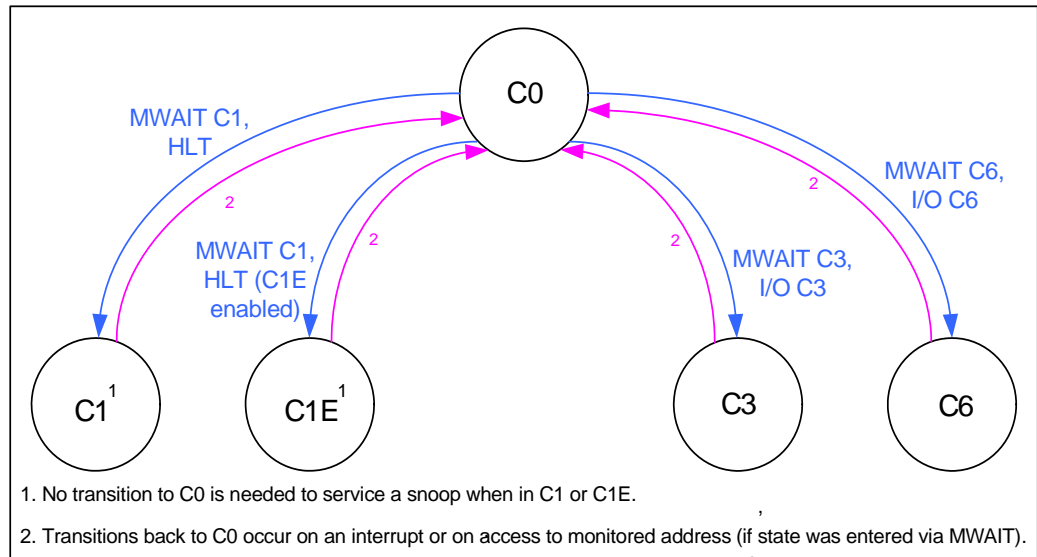
Software may make C-state requests by using a legacy method involving I/O reads from the ACPI-defined processor clock control registers, referred to as P\_LVLx. This feature is designed to provide legacy support for operating systems that initiate C-state transitions via access to pre-defined ICH registers. The base P\_LVLx register is P\_LVL2, corresponding to a C3 request. P\_LVL3 is C6, and all P\_LVL4+ are demoted to a C6.

P\_LVLx is limited to a subset of C-states supported on the processor (for example, P\_LVL8 is not supported and will not cause an I/O redirection to a C8 request. Instead, it will fall through like a normal I/O instruction). The range of I/O addresses that may be converted into C-state requests is also defined in the PMG\_IO\_CAPTURE MSR, in the



'C-state Range' field. This field may be written by BIOS to restrict the range of I/O addresses that are trapped and redirected to MWAIT instructions. Note that when I/O instructions are used, no MWAIT substates can be defined, as therefore the request defaults to have a sub-state or zero, but always assumes the 'break on EFLAGS.IF= $\neq$ 0' control that can be selected using ECX with an MWAIT instruction.

Figure 7-2. Power States



### 7.2.1 Thread and Core Power State Descriptions

Individual threads may request low power states as described below. Core power states are automatically resolved by the processor as shown in Table 7-2.

Table 7-2. Coordination of Thread Power States at the Core Level

Core State	Thread 1 State			
Thread 0 State	C0	C1 <sup>1</sup>	C3	C6
C0	C0	C0	C0	C0
C1 <sup>1</sup>	C0	C1 <sup>1</sup>	C1 <sup>1</sup>	C1 <sup>1</sup>
C3	C0	C1 <sup>1</sup>	C3	C3
C6	C0	C1 <sup>1</sup>	C3	C6

**Notes:**

- 1. If enabled, state will be C1E.

#### 7.2.1.1 C0 State

This is the normal operating state in the processor.



### 7.2.1.2 C1/C1E State

C1/C1E is a low power state entered when all threads within a core execute a HLT or MWAIT(C1E) instruction. The processor thread will transition to the C0 state upon occurrence of an interrupt or an access to the monitored address if the state was entered via the MWAIT instruction. RESET# will cause the processor to initialize itself and return to C0.

A System Management Interrupt (SMI) handler will return execution to either Normal state or the C1/C1E state. See the *Intel® 64 and IA-32 Architectures Software Developer's Manual, Volume III: System Programmer's Guide* for more information.

While in C1/C1E state, the processor will process bus snoops and snoops from the other threads.

To operate within specification, BIOS must enable the C1E feature for all installed processors.

### 7.2.1.3 C3 State

Individual threads of the processor can enter the C3 state by initiating a P\_LVL2 I/O read to the P\_BLK or an MWAIT(C3) instruction. Before entering core C3, the core flushes the contents of its caches. Except for the caches, the processor core maintains all its architectural state while in the C3 state. All of the clocks in the processor core are stopped in the C3 state.

Because the core's caches are flushed, the processor keeps the core in the C3 state when the processor detects a snoop on the Intel QuickPath Interconnect Link or when another logical processor in the same package accesses cacheable memory. The processor core will transition to the C0 state upon occurrence of an interrupt. RESET# will cause the processor core to initialize itself.

### 7.2.1.4 C6 State

Individual threads of the processor can enter the C6 state by initiating a P\_LVL3 read to the P\_BLK or an MWAIT(C6) instruction. Before entering core C6, the processor saves its state. The processor achieves additional power savings in the core C6 state.

## 7.2.2 Package Power State Descriptions

The package supports C0, C1/C1E, C3, and C6 power states. The package power state is automatically resolved by the processor depending on the core power states and permission from the rest of the system as described below.

### 7.2.2.1 Package C0 State

This is the normal operating state for the processor. The processor remains in the Normal state when at least one of its cores is in the C0 or C1 state or when another component in the system has not granted permission to the processor to go into a low power state. Individual components of the processor may be in low power states while the package is in C0.

### 7.2.2.2 Package C1/C1E State

The package will enter the C1/C1E low power state when at least one core is in the C1/C1E state and the rest of the cores are in the C1/C1E or lower power state. The processor will also enter the C1/C1E state when all cores are in a power state lower



than C1/C1E but the package low power state is limited to C1/C1E via the PMG\_CST\_CONFIG\_CONTROL MSR. In the C1E state, the processor will automatically transition to the lowest power operating point (lowest supported voltage and associated frequency). When entering the C1E state, the processor will first switch to the lowest bus ratio and then transition to the lower VID. No notification to the system occurs upon entry to C1/C1E.

To operate within specification, BIOS must enable the C1E feature for all installed processors.

### 7.2.2.3 Package C3 State

The package will enter the C3 low power state when all cores are in the C3 or lower power state and the processor has been granted permission by the other component(s) in the system to enter the C3 state. The package will also enter the C3 state when all cores are in an idle state lower than C3 but other component(s) in the system have only granted permission to enter C3.

If Intel QuickPath Interconnect L1 has been granted, the processor will disable some clocks and PLLs and for processors with an Integrated Memory Controller, the DRAM will be put into self-refresh.

### 7.2.2.4 Package C6 State

The package will enter the C6 low power state when all cores are in the C6 or lower power state and the processor has been granted permission by the other component(s) in the system to enter the C6 state. The package will also enter the C6 state when all cores are in an idle state lower than C6 but the other component(s) have only granted permission to enter C6.

If Intel QuickPath Interconnect L1 has been granted, the processor will disable some clocks and PLLs and the shared cache will enter a deep sleep state. Additionally, for processors with an Integrated Memory Controller, the DRAM will be put into self-refresh.

## 7.2.3 Intel Xeon Processor 5500 Series C-State Power Specifications

Table 7-3 lists C-State power specifications for various Intel Xeon processor 5500 series SKUs.

**Table 7-3. Processor C-State Power Specifications**

Package C-State <sup>1</sup>	130W	95W	80W <sup>2</sup>	60W <sup>3</sup>	38W
C1E	35 W	30 W	30/40 W	22 W	16 W
C3	30 W	26 W	26/35 W	18 W	12 W
C6	12 W	10 W	10/15 W	8 W	8 W

**Notes:**

1. Specifications are at  $T_{case} = 50C$  with all cores in the specified C-State.
2. Standard/Basic SKUs.
3. Applies to Low Power SKU and Intel® Xeon® Processor L5518.

### 7.3 Sleep States

The processor supports the ACPI sleep states S0, S1, S3, and S4/S5 as shown in. For information on ACPI S-states and related terminology, refer to ACPI Specification. The S-state transitions are coordinated by the processor in response PM Request (PMReq) messages from the chipset. The processor itself will never request a particular S-state.

Table 7-4. Processor S-States

S-State	Power Reduction	Allowed Transitions
S0	Normal Code Execution	S1 (via PMReq)
S1	Cores in C1E like state, processor responds with CmpD(S1) message.	S0 (via reset or PMReq) S3, S4 (via PMReq)
S3	Memory put into self-refresh, processor responds with CmpD(S3) message.	S0 (via reset)
S4/S5	Processor responds with CmpD(S4/S5) message.	S0 (via reset)

**Notes:**

1. If the chipset requests an S-state transition which is not allowed, a machine check error will be generated by the processor.

### 7.4 Intel® Turbo Boost Technology

The processor supports ACPI Performance States (P-States). The P-state referred to as P0 will be a request for Intel® Turbo Boost Technology (Intel® TBT). Intel TBT opportunistically, and automatically, allows the processor to run faster than the marked frequency if the part is operating below power, temperature and current limits. Max Turbo Boost frequency is dependent on the number of active cores and varies by processor line item configuration. Intel TBT doesn't need special hardware support, and can be enabled or disabled by BIOS.

### 7.5 Enhanced Intel SpeedStep® Technology

The processor features Enhanced Intel SpeedStep® Technology. Following are the key features of Enhanced Intel SpeedStep Technology:

- Multiple voltage and frequency operating points provide optimal performance at the lowest power.
- Voltage and frequency selection is software controlled by writing to processor MSRs:
  - If the target frequency is higher than the current frequency, V<sub>CC</sub> is ramped up in steps by placing new values on the VID pins and the PLL then locks to the new frequency.
  - If the target frequency is lower than the current frequency, the PLL locks to the new frequency and the V<sub>CC</sub> is changed through the VID pin mechanism.
  - Software transitions are accepted at any time. If a previous transition is in progress, the new transition is deferred until the previous transition completes.
- The processor controls voltage ramp rates internally to ensure smooth transitions.
- Low transition latency and large number of transitions possible per second:
  - Processor core (including shared cache) is unavailable for less than 2µs during the frequency transition.







# 8 Boxed Processor Specifications

---

## 8.1 Introduction

Intel boxed processors are intended for system integrators who build systems from components available through distribution channels. The Intel Xeon processor 5500 series will be offered as an Intel boxed processor, however the thermal solution will be sold separately.

Unlike previous-generation boxed processors, Intel Xeon processor 5500 series boxed processors will not include thermal solution in the box. Intel will offer boxed thermal solutions separately through the same distribution channels. Please reference [Section 8.1.1](#) - [Section 8.1.4](#) for more details on Boxed Processor Thermal Solutions.

### 8.1.1 Available Boxed Thermal Solution Configurations

Intel will offer three different Boxed Heat Sink solutions to support the boxed Processors.

- Boxed Intel “Combo” Thermal Solution. The Passive / Active Combination Heat Sink Solution is intended for processors with a TDP up to 130W in a pedestal or 2U+ chassis with appropriate ducting)
- Boxed Intel “Active” Thermal Solution. The Active Heat Sink Solution is intended for processors with a TDP of 80W or lower in pedestal chassis
- Boxed Intel “Passive” Thermal Solution. The 25.5 mm tall Passive Heat Sink Solution is intended for processors with a TDP of 95W or lower in Blades, 1U, or 2U chassis with appropriate ducting.

### 8.1.2 An Intel “Combo” Boxed Passive / Active Combination Heat Sink Solution

The Passive / Active combination solution, based on a 2U passive heat sink with a removable fan, is intended for use with processors with TDP's up to 130 W. This heat pipe based solution is intended to be used as either a passive heat sink in a 2U or larger chassis, or as an active heat sink for pedestal chassis. [Figure 8-2](#) and [Figure 8-3](#) are representations of the heat sink solution. Although the active combination solution with the removable fan installed mechanically fits into a 2U keepout, its use has not been validated in that configuration.

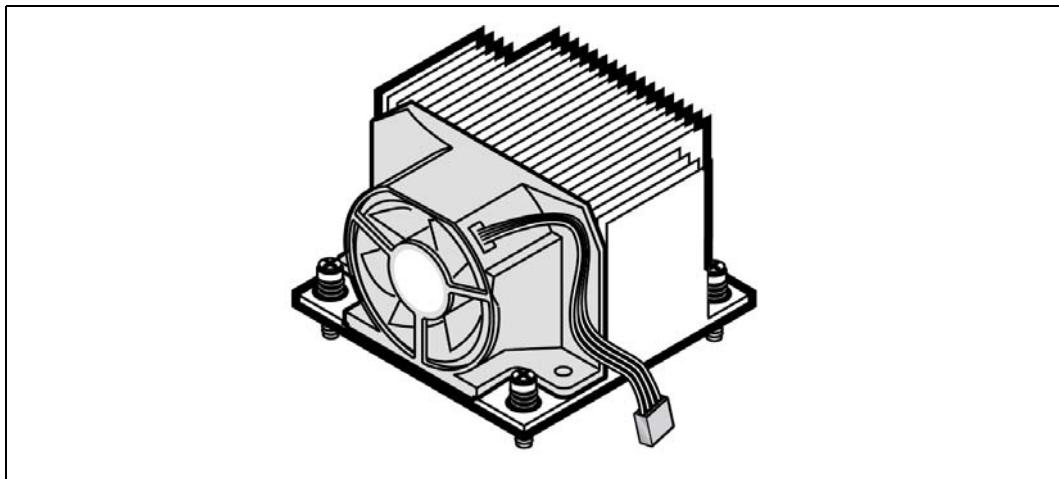
The Passive / Active combination solution in the active fan configuration is primarily designed to be used in a pedestal chassis where sufficient air inlet space is present. The Passive / Active combination solution with the fan removed, as with any passive thermal solution, will require the use of chassis ducting and are targeted for use in rack mount or ducted pedestal servers. The retention solution used for these products is called Unified Retention System (URS).

### 8.1.3 Intel Boxed “Active” Heat Sink Solution

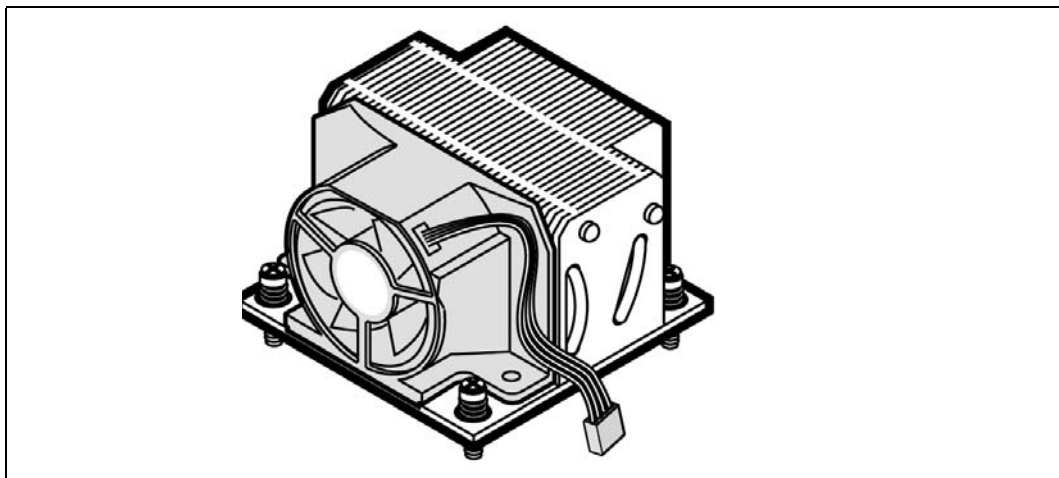
The Boxed Active solution will be available for purchase for processors with TDP's of 80W and lower and will be an aluminum extrusion. This heat sink solution is intended to be used as an active heat sink only for pedestal chassis. [Figure 8-1](#) is a representation of the heat sink solution.

Both active solutions will utilize a fan capable of 4-pin pulse width modulated (PWM) control. Use of a 4-pin PWM controlled active thermal solution helps customers meet acoustic targets in pedestal platforms through the baseboard's ability to directly control the RPM of the processor heat sink fan. See [Section 8.3](#) for more details on fan speed control, also see [Section 6.3](#) for more on the PWM and PECL interface along with Digital Thermal Sensors (DTS).

**Figure 8-1. Boxed Active Heat Sink**

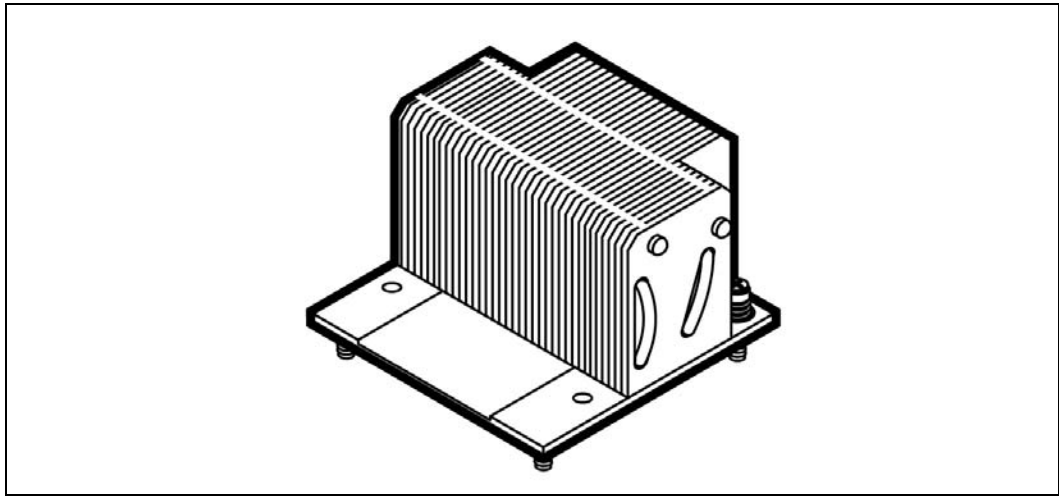


**Figure 8-2. Boxed Passive / Active Combination Heat Sink (With Removable Fan)**

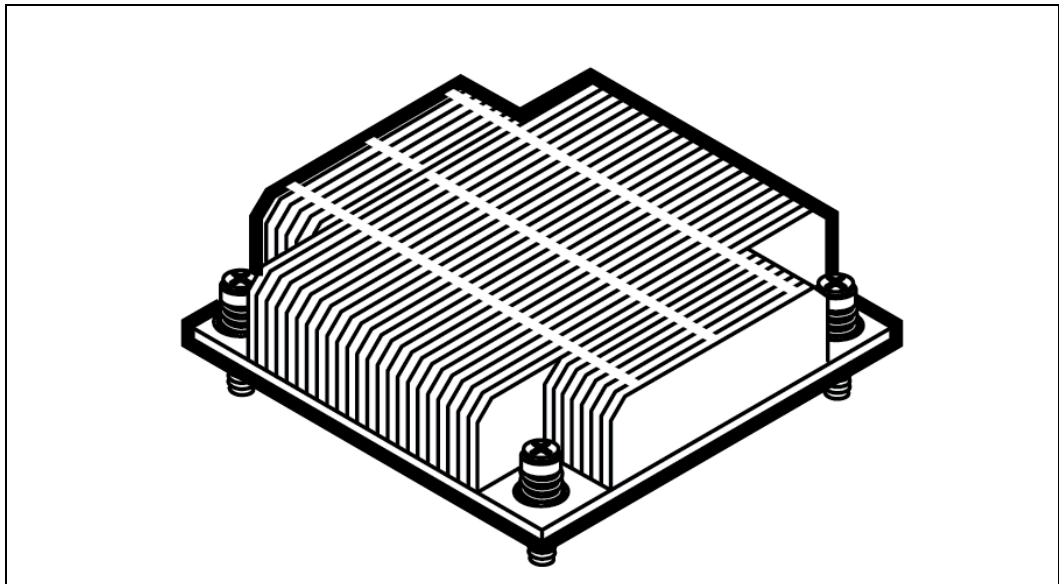




**Figure 8-3. Boxed Passive/Active Combination Heat Sink (with Fan Removed)**



**Figure 8-4. Intel Boxed 25.5 mm Tall Passive Heat Sink Solution**



#### 8.1.4 Intel Boxed 25.5mm Tall Passive Heat Sink Solution

The boxed 25.5 mm Tall heatsink solution will be available for use with boxed processors that have TDP's of 95 W and lower. The 25.5 mm Tall passive solution is designed to be used in Blades, 1U, and 2U chassis where ducting is present. The use of a 25.5 mm Tall heatsink in a 2U chassis is recommended to achieve a lower heatsink  $T_{LA}$  and a more optimized heatsink design. Figure 8-4 is a representation of the heat sink solution. The retention solution used for these products is called Unified Retention System (URS).



## 8.2 Mechanical Specifications

This section documents the mechanical specifications of the boxed processor solution.

### 8.2.1 Boxed Processor Heat Sink Dimensions and Baseboard Keepout Zones

The boxed processor and boxed thermal solution will be sold separately. Clearance is required around the thermal solution to ensure unimpeded airflow for proper cooling. Baseboard keepout zones are shown in [Figure 8-5](#) through [Figure 8-8](#). Physical space requirements and dimensions for the boxed processor and assembled heat sink are shown in [Figure 8-9](#). Mechanical drawings for the 4-pin fan header and 4-pin connector used for the active fan heat sink solution are represented in [Figure 8-11](#) and [Figure 8-12](#).

None of the heat sink solutions exceed a mass of 550 grams. Note that this is per processor, a dual processor system will have up to 1100 grams total mass in the heat sinks.

See [Section 3](#) for details on the processor mass.







Figure 8-7. Bottom Side Baseboard Keep-Out Zones

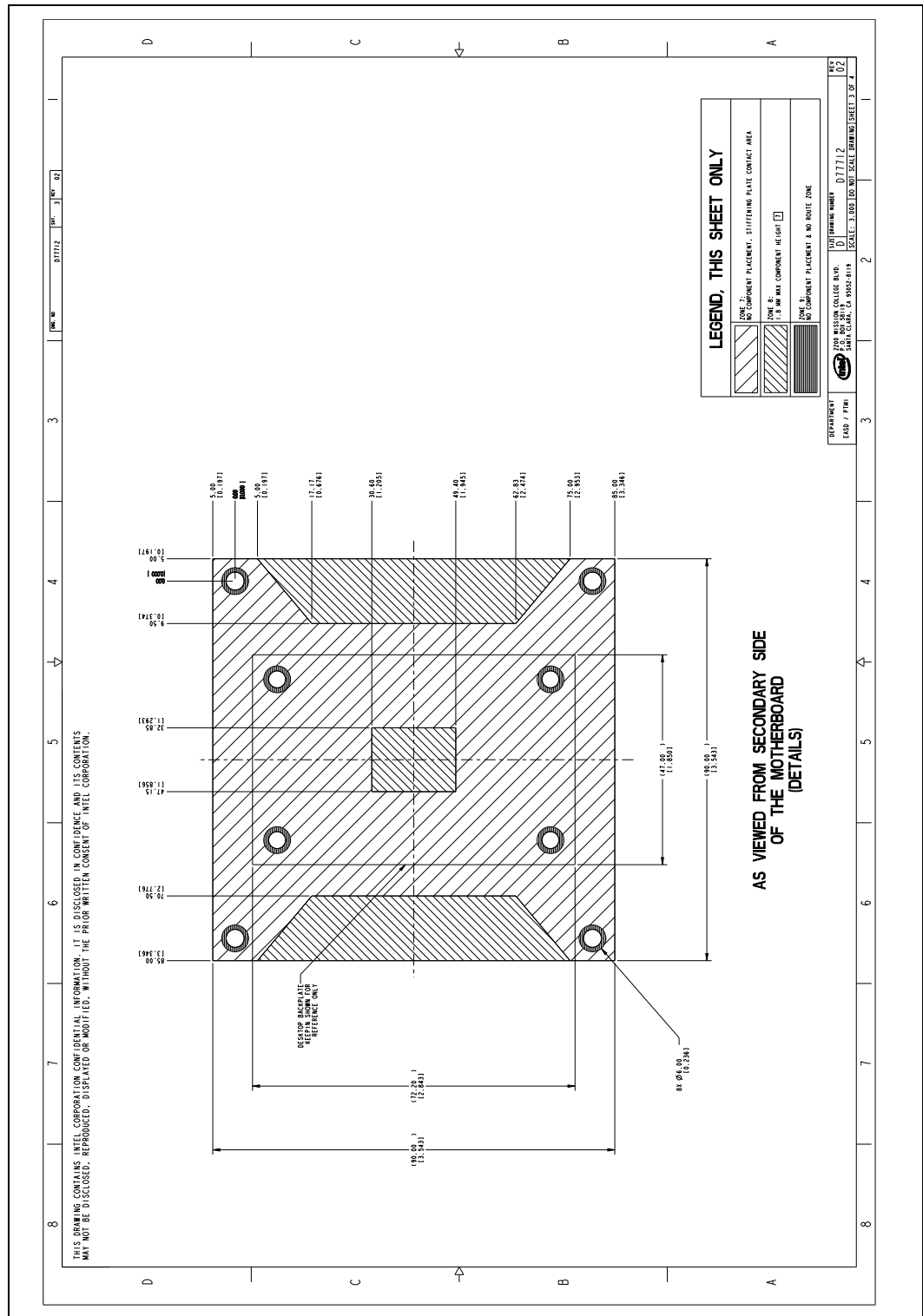


Figure 8-8. Primary and Secondary Side 3D Height Restriction Zones

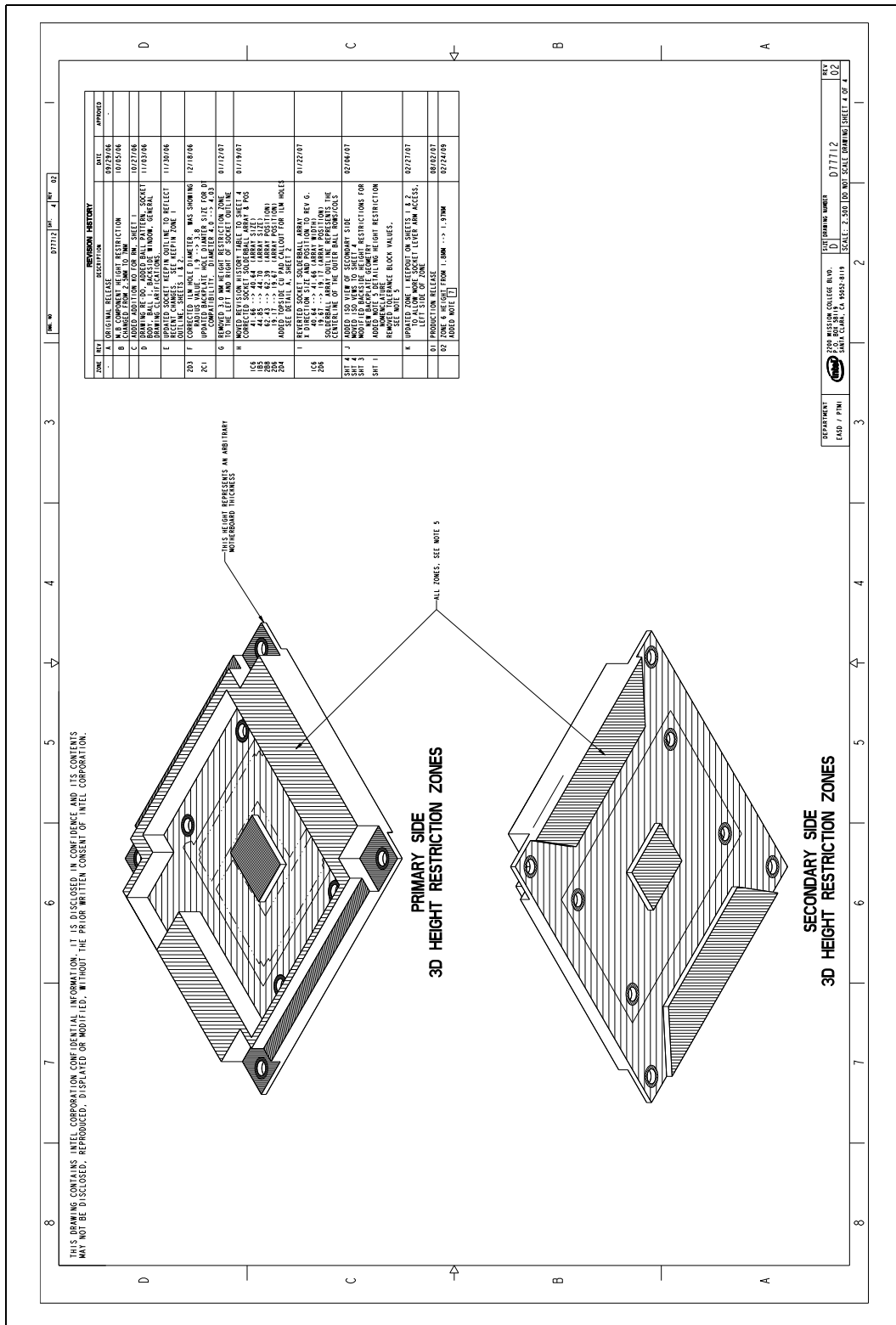






Figure 8-9. Volumetric Height Keep-Ins

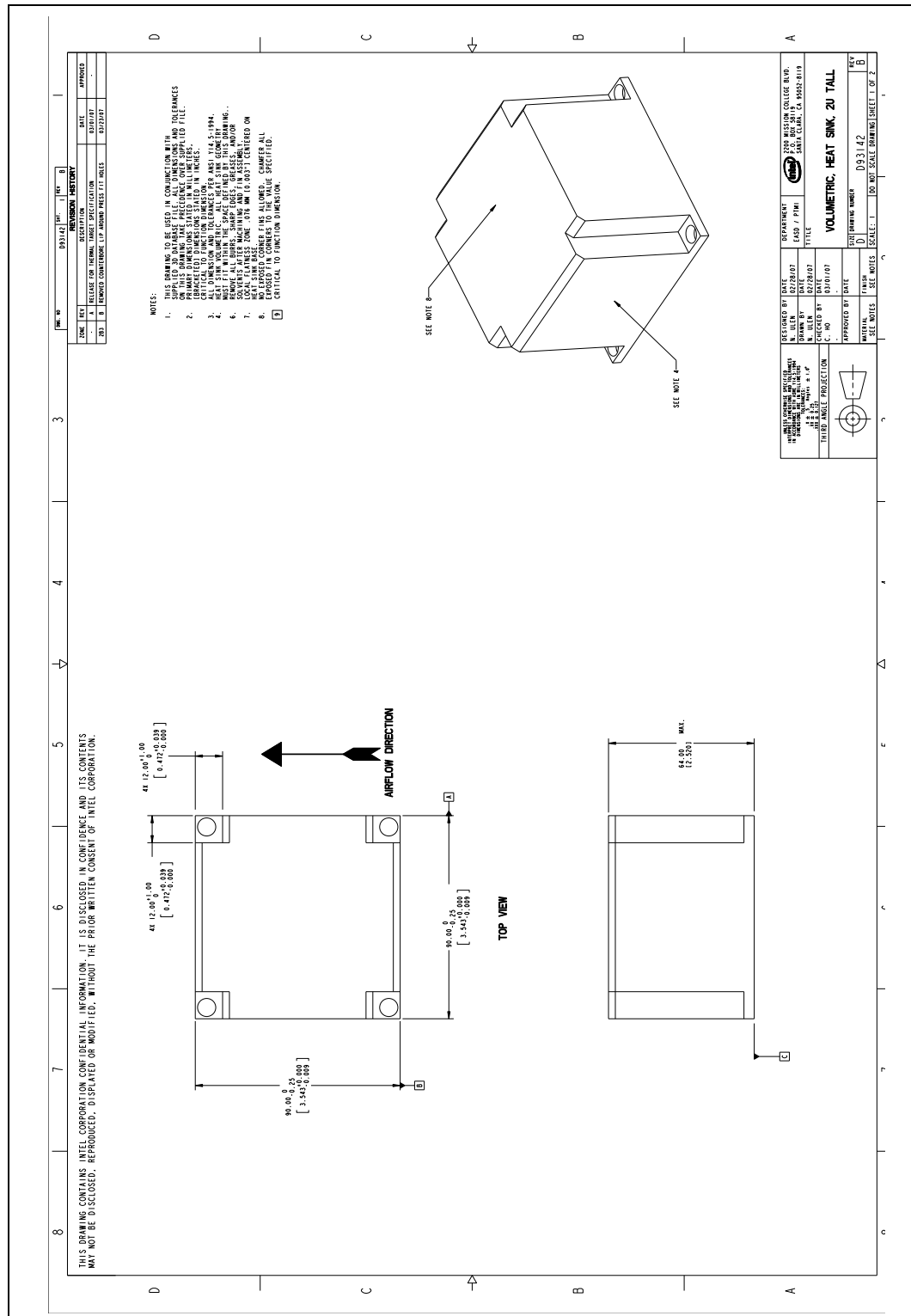
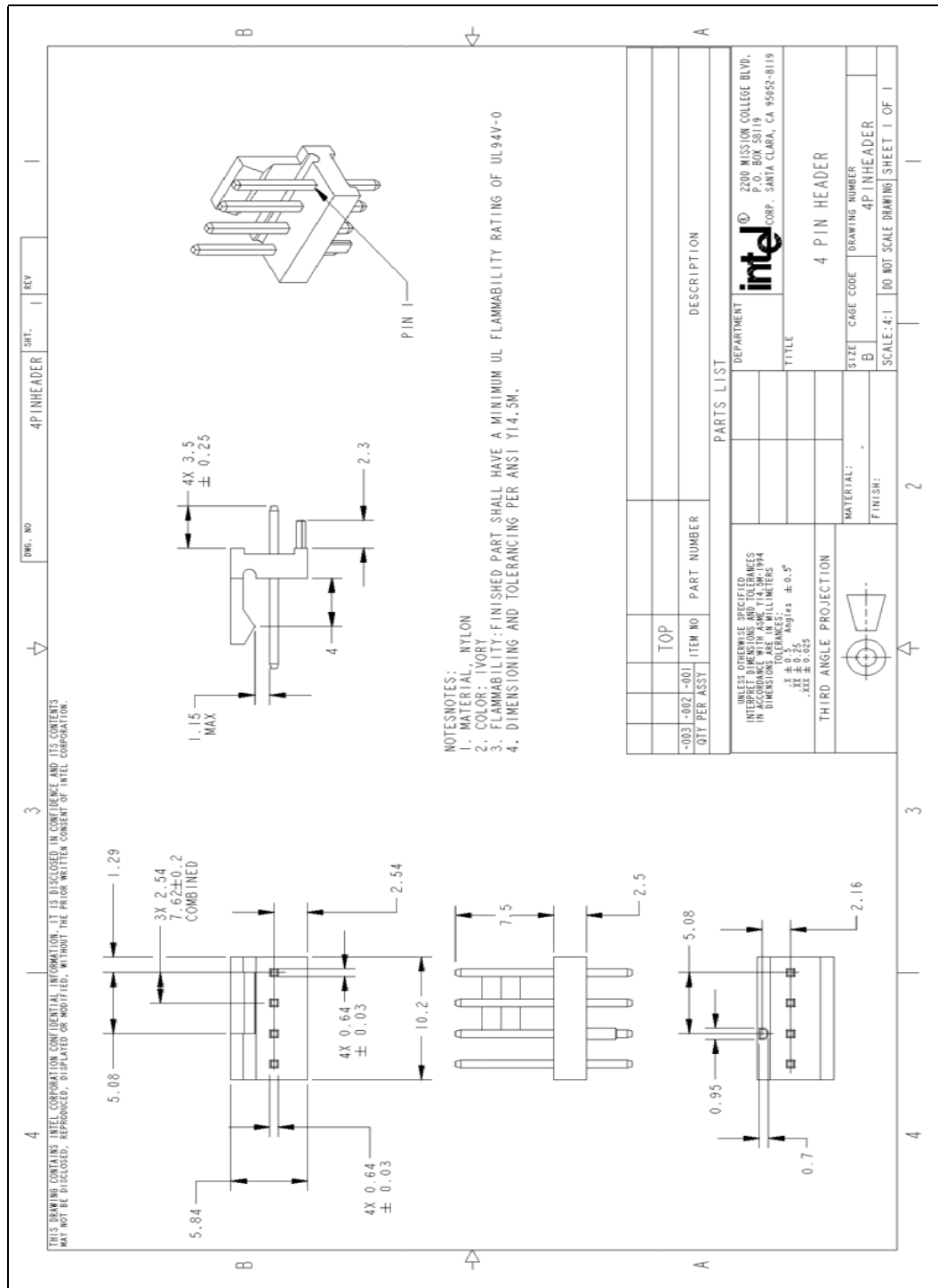






Figure 8-12. 4-Pin Base Baseboard Fan Header (For Active Heat Sink)





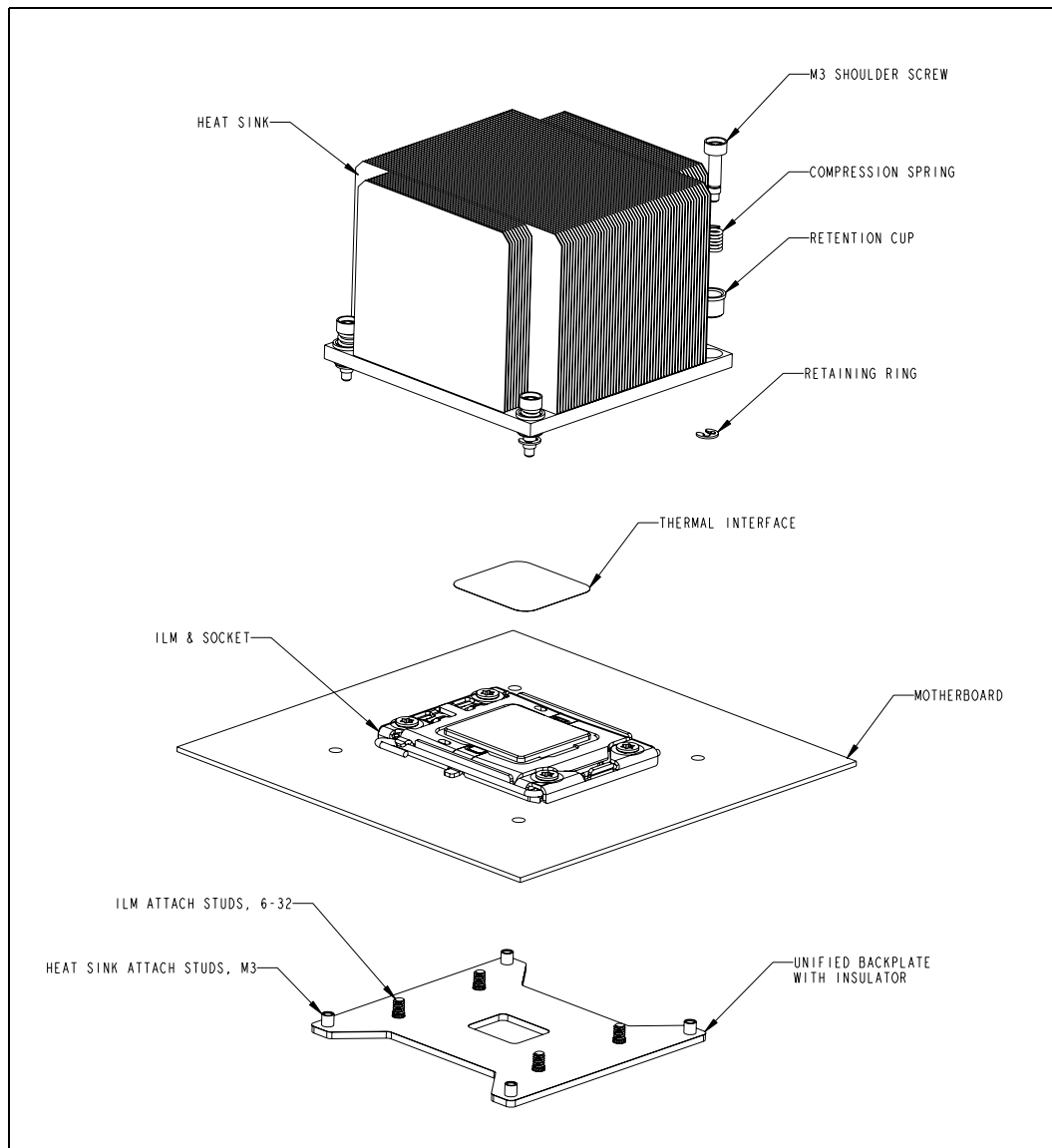
## 8.2.2 Boxed Processor Retention Mechanism and Heat Sink Support (URS)

Baseboards designed for use by a system integrator should include holes that are in proper alignment with each other to support the boxed processor. Refer to [Figure 8-5](#) for mounting hole dimensions.

[Figure 8-13](#) illustrates the Unified Retention System (URS) and the Unified Backplate Assembly. The URS is designed to extend air-cooling capability through the use of larger heat sinks with minimal airflow blockage and bypass. URS retention transfers load to the baseboard via the Unified Backplate Assembly. The URS spring, captive in the heatsink, provides the necessary compressive load for the thermal interface material. For specific design details on the URS and the Unified Backplate please refer to the *Intel® Xeon® Processor 5500 Series Thermal / Mechanical Design Guide*.

All components of the URS heat sink solution will be captive to the heat sink and will only require a Phillips screwdriver to attach to the Unified Backplate Assembly. When installing the URS the screws should be tightened until they will no longer turn easily. This should represent approximately 8 inch-pounds of torque. More than that may damage the retention mechanism components.

Figure 8-13. Thermal Solution Installation



### 8.3 Fan Power Supply (“Combo” and “Active” Solution)

The 4-pin PWM controlled thermal solution is being offered to help provide better control over pedestal chassis acoustics. This is achieved through more accurate measurement of processor die temperature through the processor’s Digital Thermal Sensors. Fan RPM is modulated through the use of an ASIC located on the baseboard that sends out a PWM control signal to the 4th pin of the connector labeled as Control. This thermal solution requires a constant +12 V supplied to pin 2 of the active thermal solution and does not support variable voltage control or 3-pin PWM control. See [Table 8-1](#) through [Table 8-3](#) for details on the 4-pin active heat sink solution connectors.



The fan power header on the baseboard must be positioned to allow the fan heat sink power cable to reach it. The fan power header identification and location must be documented in the suppliers platform documentation, or on the baseboard itself. The baseboard fan power header should be positioned within 177.8 mm [7 in.] from the center of the processor socket.

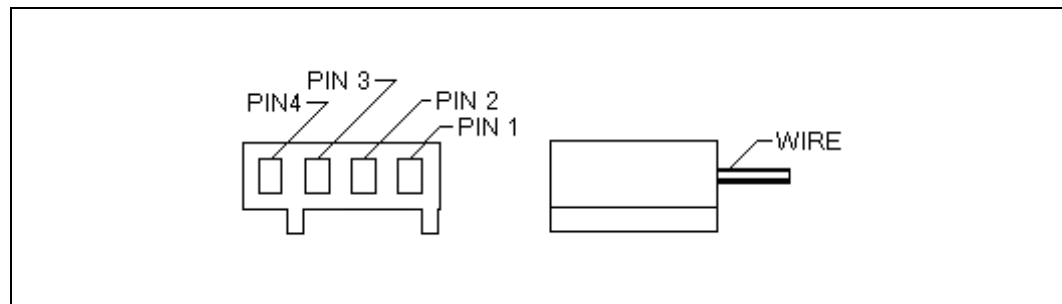
**Table 8-1. PWM Fan Frequency Specifications For 4-Pin Active Thermal Solution**

Description	Min Frequency	Nominal Frequency	Max Frequency	Unit
PWM Control Frequency Range	21,000	25,000	28,000	Hz

**Table 8-2. Fan Specifications For 4-Pin Active Thermal Solution**

Description	Min	Typ Steady	Max Steady	Max Startup	Unit
+12 V: 12 volt fan power supply	10.8	12	12	13.2	V
IC: Fan Current Draw	N/A	1.25	1.5	2.2	A
SENSE: SENSE frequency	2	2	2	2	Pulses per fan revolution

**Figure 8-14. Fan Cable Connector Pin Out For 4-Pin Active Thermal Solution**



**Table 8-3. Fan Cable Connector Pin Out for 4-Pin Active Thermal Solution**

Pin Number	Signal	Color
1	Ground	Black
2	<b>Power:</b> (+12 V)	Yellow
3	<b>Sense:</b> 2 pulses per revolution	Green
4	<b>Control:</b> 21 KHz-28 KHz	Blue

### 8.3.1 Boxed Processor Cooling Requirements

As previously stated the boxed processor will have three cooling solutions available. Each configuration will require unique design considerations. Meeting the processor’s temperature specifications is also the function of the thermal design of the entire system, and ultimately the responsibility of the system integrator. The processor temperature specifications are found in [Section 6](#) of this document.



### 8.3.1.1 2U Passive / Active Combination Heat Sink Solution

#### Active Configuration:

The active configuration of the combination solution is designed to help pedestal chassis users to meet the thermal processor requirements without the use of chassis ducting. It may be still be necessary to implement some form of chassis air guide or air duct to meet the  $T_{LA}$  temperature of 40°C depending on the pedestal chassis layout. Use of the active configuration in a 2U rackmount chassis is not recommended.

It is recommended that the ambient air temperature outside of the chassis be kept at or below 35°C. The air passing directly over the processor thermal solution should not be preheated by other system components. Meeting the processor's temperature specification is the responsibility of the system integrator.

This thermal solution is for use with 95 W and 130 W TDP processor SKUs.

#### Passive Configuration:

In the passive configuration it is assumed that a chassis duct will be implemented. Processors with a TDP of 130 W or 95 W must provide a minimum airflow of 30 CFM at 0.205 in.  $H_2O$  (51 m<sup>3</sup>/hr at 51.1 Pa) of flow impedance. For processors with a TDP of 130 W it is assumed that a 40°C  $T_{LA}$  is met. This requires a superior chassis design to limit the  $T_{RISE}$  at or below 5°C with an external ambient temperature of 35°C. For processors with a TDP of 95W it is assumed that a 55°C  $T_{LA}$  is met.

### 8.3.1.2 Active Heat Sink Solution (Pedestal only)

This active solution is designed to help pedestal chassis users to meet the thermal processor requirements without the use of chassis ducting. It may be still be necessary to implement some form of chassis air guide or air duct to meet the  $T_{LA}$  temperature of 49°C depending on the pedestal chassis layout. Use of this active solution in a 2U rackmount chassis has not been validated.

It is recommended that the ambient air temperature outside of the chassis be kept at or below 35°C. The air passing directly over the processor thermal solution should not be preheated by other system components. Meeting the processor's temperature specification is the responsibility of the system integrator.

This thermal solution is for use with processor SKUs no higher than 80W.

### 8.3.1.3 25.5 mm Tall Passive Heat Sink Solution (Blade + 1U + 2U Rack)

**Note:** 95 W SKU's using the 25.5 mm Tall passive HS are only intended for use in 1U rack configurations (Thermal Profile B). For use in 2U configurations see [Section 8.3.1.2](#) for details.

In the Blade, 1U and 2U configurations it is assumed that a chassis duct will be implemented. Due to the complexity of the number of chassis and baseboard configurations, several airflow and flow impedance values exist. Please refer to the *Intel® Xeon® Processor 5500/5600 Series Thermal / Mechanical Design Guide* for detailed mechanical drawings and specific airflow and impedance values applicable to your use conditions. It is recommended that the ambient air temperature outside of the chassis be kept at or below 35°C.





## 8.4 Boxed Processor Contents

The Boxed Processor and Boxed Thermal Solution contents are outlined below.

- Boxed Processor Contents
  - Intel Xeon processor 5500 series
  - Installation and warranty manual
  - Intel Inside Logo
- Boxed Thermal Solution
  - Heat sink assembly solution
  - Thermal interface material (pre-applied on heat sink, if included)
  - Installation and warranty manual

§



# Mouser Electronics

Authorized Distributor

Click to View Pricing, Inventory, Delivery & Lifecycle Information:

[Intel:](#)

[AT80602000801AAS LBF9](#) [AT80602002697ACS LBGK](#) [AT80612003861ABS LBWL](#)